



WT100-2P1412S01

W100-2

MINIATURE PHOTOELECTRIC SENSORS

SICK
Sensor Intelligence.



Illustration may differ



Ordering information

Type	Part no.
WT100-2P1412S01	6052402

Other models and accessories → www.sick.com/W100-2

Detailed technical data

Features

Functional principle	Photoelectric proximity sensor
Functional principle detail	Background blanking
Dimensions (W x H x D)	11 mm x 31 mm x 20 mm
Housing design (light emission)	Rectangular
Sensing range max.	10 mm ... 170 mm ¹⁾
Sensing range	10 mm ... 150 mm ¹⁾
Type of light	Visible red light
Light source	LED ²⁾
Light spot size (distance)	Ø 8 mm (90 mm)
Wave length	632 nm
Adjustment	None

¹⁾ Object with 90% remission (based on standard white, DIN 5033).

²⁾ Average service life: 100,000 h at T_U = +25 °C.

Mechanics/electronics

Supply voltage U_B	10 V DC ... 30 V DC ¹⁾
Ripple	± 10 % ²⁾

¹⁾ Limit values.

²⁾ May not exceed or fall below U_V tolerances.

³⁾ Without load.

⁴⁾ Signal transit time with resistive load.

⁵⁾ With light/dark ratio 1:1.

⁶⁾ Do not bend below 0 °C.

⁷⁾ A = V_S connections reverse-polarity protected.

⁸⁾ B = output reverse-polarity protected.

⁹⁾ D = outputs overcurrent and short-circuit protected.

Current consumption	30 mA ³⁾
Switching output	PNP
Switching mode	Dark switching
Signal voltage PNP HIGH/LOW	$U_V - 1,8 \text{ V} / \text{ca. } 0 \text{ V}$
Output current I_{max}	$\leq 100 \text{ mA}$
Response time	$\leq 0,5 \text{ ms}^4)$
Switching frequency	1,000 Hz ⁵⁾
Connection type	Cable with Stocko-connector, 260 mm ⁶⁾
Cable material	PVC
Circuit protection	A ⁷⁾ B ⁸⁾ D ⁹⁾
Protection class	III
Housing material	Plastic, ABS/PC/POM
Optics material	Plastic, PMMA
Enclosure rating	IP67
Ambient operating temperature	-25 °C ... +55 °C
Ambient temperature, storage	-40 °C ... +70 °C

- 1) Limit values.
- 2) May not exceed or fall below U_V tolerances.
- 3) Without load.
- 4) Signal transit time with resistive load.
- 5) With light/dark ratio 1:1.
- 6) Do not bend below 0 °C.
- 7) A = V_S connections reverse-polarity protected.
- 8) B = output reverse-polarity protected.
- 9) D = outputs overcurrent and short-circuit protected.

Classifications

ECLASS 5.0	27270903
ECLASS 5.1.4	27270903
ECLASS 6.0	27270903
ECLASS 6.2	27270903
ECLASS 7.0	27270903
ECLASS 8.0	27270903
ECLASS 8.1	27270903
ECLASS 9.0	27270903
ECLASS 10.0	27270904
ECLASS 11.0	27270904
ECLASS 12.0	27270903
ETIM 5.0	EC001821
ETIM 6.0	EC001821
ETIM 7.0	EC002719
ETIM 8.0	EC002719

UNSPSC 16.0901

39121528

Dimensional drawing (Dimensions in mm (inch))

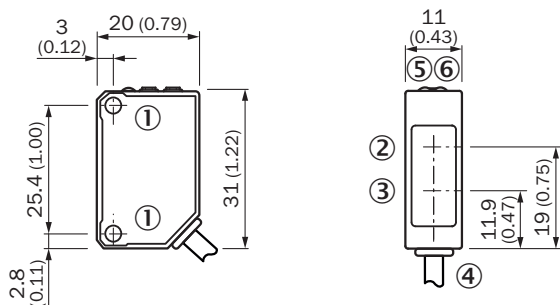

- ① Threaded mounting hole M3
- ② Center of optical axis, receiver
- ③ Center of optical axis, sender
- ④ Connection
- ⑤ LED indicator orange: switching output active
- ⑥ LED indicator green: power on

Adjustments

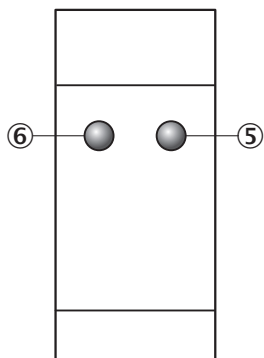

- ⑤ LED indicator orange: output active
- ⑥ LED indicator green: stability indicator

Connection diagram

Cd-043

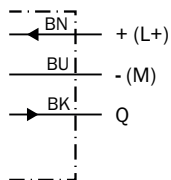

Characteristic curve

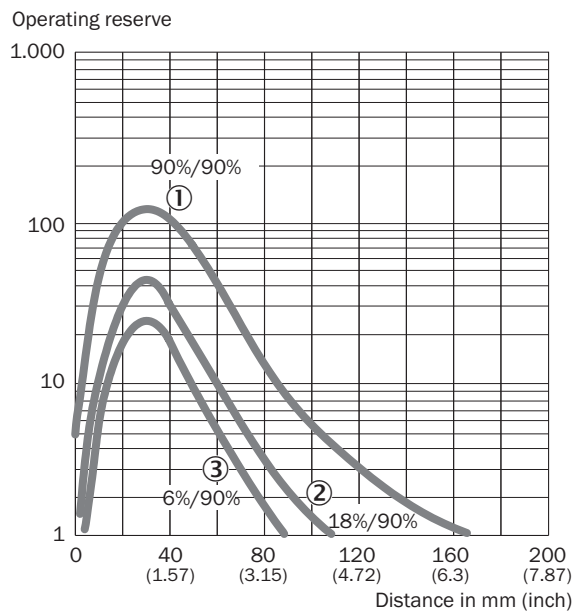

- ① Sensing range on white, 90% remission factor
- ② Sensing range on gray, 18% remission factor
- ③ Sensing range on black, 6% remission factor

Light spot size

Light spot size

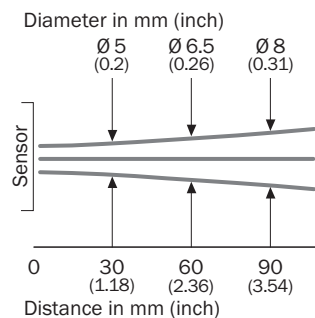

Recommended accessories

Other models and accessories → www.sick.com/W100-2

	Brief description	Type	Part no.
Mounting brackets and plates			
	Mounting bracket for wall mounting, stainless steel, mounting hardware included	BEF-W100-A	5311520

WT100-2P1412S01 | W100-2

MINIATURE PHOTOELECTRIC SENSORS

	Brief description	Type	Part no.
	Mounting bracket for floor mounting, steel, zinc coated, mounting hardware included	BEF-W100-B	5311521

SICK AT A GLANCE

SICK is one of the leading manufacturers of intelligent sensors and sensor solutions for industrial applications. A unique range of products and services creates the perfect basis for controlling processes securely and efficiently, protecting individuals from accidents and preventing damage to the environment.

We have extensive experience in a wide range of industries and understand their processes and requirements. With intelligent sensors, we can deliver exactly what our customers need. In application centers in Europe, Asia and North America, system solutions are tested and optimized in accordance with customer specifications. All this makes us a reliable supplier and development partner.

Comprehensive services complete our offering: SICK LifeTime Services provide support throughout the machine life cycle and ensure safety and productivity.

For us, that is “Sensor Intelligence.”

WORLDWIDE PRESENCE:

Contacts and other locations –www.sick.com