



Product designation				Enclosed switch disconnecter
Product type designation				GAZM
Number of poles		Nr.		4
Operating voltage type				AC
Contact characteristics				
IEC Conventional free air thermal current I _{th}		A		63
Rated insulation voltage U _i IEC/EN		V		1000
Rated impulse withstand voltage U _{imp}		kV		8
Operating current I _e				
	AC21A			
		400V	A	63
		500V	A	63
		690V	A	63
	AC22A			
		400V	A	63
		500V	A	63
		690V	A	63
	AC23A			
		400V	A	63
		500V	A	63
		690V	A	47
Power dissipation per pole max			W	1.6
Rated operational power AC23A				
		400V	kW	30
		690V	kW	45
Conditional short-circuit current (rms)			kA	50
Short-circuit protection with fuse			Class/A	gG63
Making capacity AC23A 400V			A	1250
Breaking capacity AC23A 400V			A	1000
Mechanical life			cycles	30000
Electrical life AC21A			cycles	30000
Mechanical features				
Operating position		normal allowable		Vertical plan Any
Terminals				
		type		Pillar
		width	mm	12.4
		height	mm	10.4
		screw		M8
		tool		Metric Allen key 4
Tightening torque for terminals				
		min	Nm	5
		max	Nm	6

	min	lbin	45
	max	lbin	54

Conductor section

IEC min	mm ²	4
IEC max	mm ²	70
AWG/kcmil min		12
AWG/kcmil max		1

Ambient conditions

Operating temperature

min	°C	-25
max	°C	+55

Storage temperature

min	°C	-40
max	°C	+70

Max altitude

m	3000
---	------

Resistance & Protection

Frontal IP degree

IP65

IP degree of protection

IP65

Pollution degree

3

Dimensions

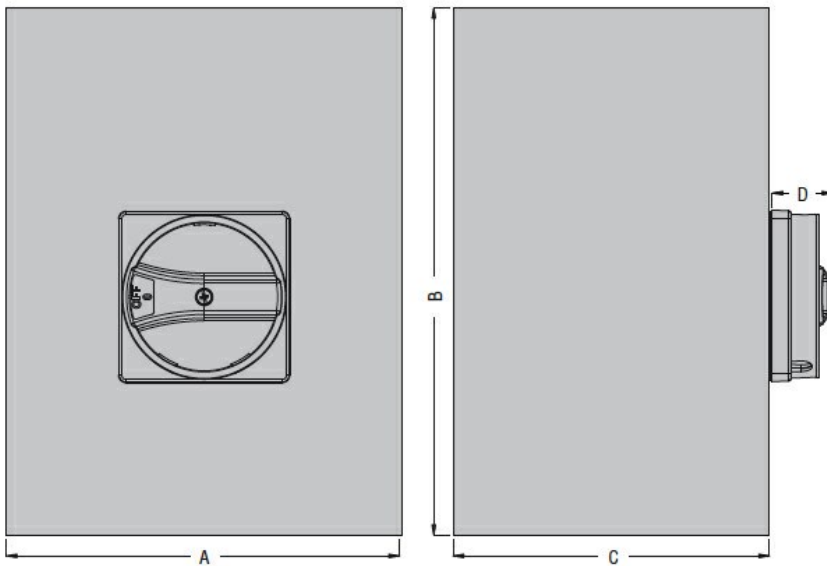

Type	A	B	C	D
GAZM016...GAZM100...	150 (5.90")	200 (7.87")	120 (4.72")	23 (0.90")

Wiring diagrams

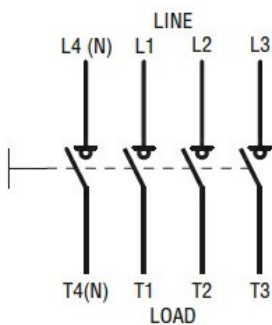

Certifications and compliance

Compliance

IEC/EN 60947-1

IEC/EN 60947-3

ETIM classification

ETIM 8.0

EC000216 -
Switch
disconnector