



DME4000-213

DME4000

LONG RANGE DISTANCE SENSORS

SICK
Sensor Intelligence.



Ordering information

Type	Part no.
DME4000-213	1029798

Other models and accessories → www.sick.com/DME4000



Detailed technical data

Mechanics/electronics

Supply voltage V_s	DC 18 V ... 30 V, limit values
Ripple	< 5 V _{pp} ¹⁾
Initialization time	1.5 s ²⁾
Housing material	Metal (zinc diecast)
Window material	Glass
Connection type	Male connector, M16, 8-pin
Indication	Display
Weight	Approx. 1,650 g
Current consumption	At 24 V DC < 250 mA
Dimensions (W x H x D)	61 mm x 85 mm x 166 mm
Enclosure rating	IP65
Protection class	II ³⁾

¹⁾ May not fall short of or exceed V_s tolerances.

²⁾ After loss of reflector < 1 s at max. speed V_{max} < 1 m/s.

³⁾ Reference voltage DC 32 V.

Safety-related parameters

MTTF_D	101 years
DC_{avg}	0%

Performance

Measurement range min ... max:	0.15 m ... 130 m, on "diamond grade" reflective tape
Target	Reflector
Resolution	0.05 mm ... 5 mm

¹⁾ On "diamond grade" reflective tape.

²⁾ Statistical error 1 σ , environmental conditions constant, min. warm-up time 10 min.

³⁾ Average service life of 50,000 h at $T_A = +25$ °C.

Repeatability	2 mm ^{1) 2)}
Accuracy	± 5 mm
Response time	6 ms
Output time	2 ms
Light source	Laser, red ³⁾ visible red light
Laser class	2, complies with 21 CFR 1040.10 and 1040.11 except for the conformance according to "Laser Notice No. 50" from June 24, 2007 (IEC 60825-1:2014, EN 60825-1:2014)
Typ. light spot size (distance)	130 mm (at 70 m) 270 mm (at 150 m) 360 mm (at 220 m)
Max. movement speed	10 m/s

¹⁾ On "diamond grade" reflective tape.

²⁾ Statistical error 1 σ , environmental conditions constant, min. warm-up time 10 min.

³⁾ Average service life of 50,000 h at $T_A = +25$ °C.

Interfaces

Serial	✓, RS-422
Digital output	
Number	2
Type	Push-pull: PNP/NPN
Maximum output current I_A	≤ 100 mA ^{1) 2)}
Multifunctional input (MF)	1 x MF ^{3) 4)}

¹⁾ Max. 100 nF/20 mH.

²⁾ HIGH = > $V_S - 3$ V / LOW = < 2 V.

³⁾ HIGH = > 12 V / LOW = < 3 V.

⁴⁾ Not reverse-polarity protected.

Ambient data

Electromagnetic compatibility (EMC)	EN 61000-6-2, EN 55011: Class B
Ambient temperature, operation	-10 °C ... +55 °C -10 °C ... +75 °C, operation with cooling case
Ambient temperature, storage	-25 °C ... +75 °C
Effect of air pressure	0.3 ppm/hPa
Effect of air temperature	1 ppm/K
Temperature drift	Typ. 0.1 mm/K
Typ. Ambient light immunity	≤ 40,000 lx
Mechanical load	Shock: (EN 600 68-2-27 / -2-29) Sine: (EN 600 68-2-6) Noise: (EN 600 68-2-64)

Classifications

ECLASS 5.0	27270801
ECLASS 5.1.4	27270801
ECLASS 6.0	27270801
ECLASS 6.2	27270801
ECLASS 7.0	27270801

ECLASS 8.0	27270801
ECLASS 8.1	27270801
ECLASS 9.0	27270801
ECLASS 10.0	27270801
ECLASS 11.0	27270801
ECLASS 12.0	27270916
ETIM 5.0	EC001825
ETIM 6.0	EC001825
ETIM 7.0	EC001825
ETIM 8.0	EC001825
UNSPSC 16.0901	41111613

Dimensional drawing (Dimensions in mm (inch))

DME4000 RS-422

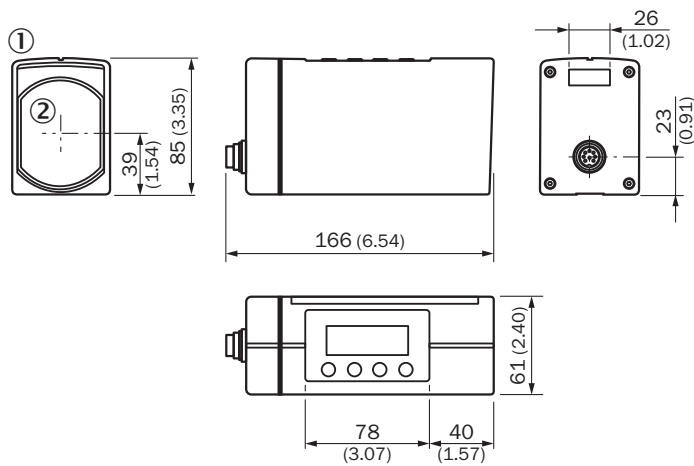

- ① LC display
- ② Center of optical axis

Connection type

DME4/5xxx SSI/RS-422 Connector M16, 8-pin



Connection diagram

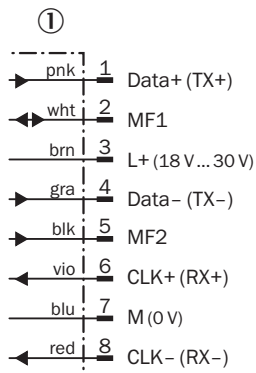

① Connector M16, 8-pin

Adjustment possible

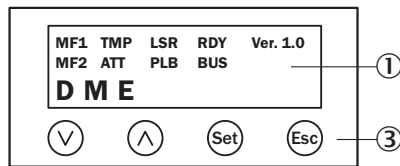









- ① LC display
- ③ Keypad

Recommended accessories

Other models and accessories → www.sick.com/DME4000

	Brief description	Type	Part no.
Plug connectors and cables			
	<ul style="list-style-type: none"> • Connection type head A: Female connector, M12, 5-pin, straight, B-coded • Connection type head B: Flying leads • Signal type: PROFIBUS DP • Cable: 5 m, 2-wire, PUR, halogen-free • Description: PROFIBUS DP, twisted pair, shielded, Head A: female connector, M12, 5-pin, straight Head B: cable Cable: suitable for drag chain, PUR, halogen-free, shielded, 2 x 0.34 mm², Ø 8.0 mm • Connection systems: Flying leads • Application: Zones with oils and lubricants 	DOL-1205-G05MQ	6026006
	<ul style="list-style-type: none"> • Connection type head A: Female connector, M12, 5-pin, A-coded • Connection type head B: Flying leads • Signal type: Power, CAN • Cable: 5 m, 5-wire • Description: Power, unshieldedCAN 	DOL-1205-G05M_Can	6021166
	<ul style="list-style-type: none"> • Connection type head A: Female connector, M12, 5-pin, straight • Connection type head B: Flying leads • Signal type: CANopen • Cable: 6 m • Description: CANopen, shielded 	DOL-1205-G06MK	6028326

	Brief description	Type	Part no.
	<ul style="list-style-type: none"> Connection type head A: Female connector, M12, 5-pin, straight, B-coded Connection type head B: Flying leads Signal type: PROFIBUS DP Cable: 10 m, 2-wire, PUR, halogen-free Description: PROFIBUS DP, twisted pair, shielded Connection systems: Flying leads Application: Zones with oils and lubricants 	DOL-1205-G10MQ	6026008
	<ul style="list-style-type: none"> Connection type head A: Female connector, M12, 5-pin, straight, B-coded Connection type head B: Flying leads Signal type: PROFIBUS DP Cable: 15 m, 2-wire, PUR, halogen-free Description: PROFIBUS DP, twisted pair, shielded Connection systems: Flying leads Application: Zones with oils and lubricants 	DOL-1205-G15MQ	6032637
	<p>Head A: male connector, M12, 5-pin, straight, B-coded Head B: Flying leads Cable: PROFIBUS DP, twisted pair, PUR, halogen-free, shielded, 5 m Wire shield Al-Pt film, overall shield C-screen tin-plated</p>	STL-1205-G05MQ	6026005
	<ul style="list-style-type: none"> Connection type head A: Male connector, M12, 5-pin, straight, B-coded Connection type head B: Flying leads Signal type: PROFIBUS DP Cable: 10 m, 2-wire, PUR, halogen-free Description: PROFIBUS DP, twisted pair, shielded Note: Wire shield Al-Pt film, overall shield C-screen tin-plated Application: Zones with oils and lubricants, Drag chain operation 	STL-1205-G10MQ	6026007
	<p>Head A: male connector, M12, 5-pin, straight, B-coded Head B: Flying leads Cable: PROFIBUS DP, twisted pair, PUR, halogen-free, shielded, 15 m</p>	STL-1205-G15MQ	6036898
	<ul style="list-style-type: none"> Connection type head A: Female connector, M12, 5-pin, straight Connection type head B: Flying leads Signal type: CANopen Cable: 10 m, 5-wire Description: CANopen, shielded Connection systems: Flying leads Note: Shielded on pin 1 	YF2A14-100C1BXLEAX	6021175
	<p>Head A: female connector, M12, 8-pin, straight Head B: Flying leads Cable: PUR, halogen-free, shielded, 2 m</p>	YF2A68-020XXXXLEAX	6032448
	<p>Head A: female connector, M12, 8-pin, straight Head B: Flying leads Cable: PUR, halogen-free, shielded, 5 m</p>	YF2A68-050XXXXLEAX	6032449
	<p>Head A: female connector, M12, 8-pin, straight Head B: Flying leads Cable: PUR, halogen-free, shielded, 10 m</p>	YF2A68-100XXXXLEAX	6032450
	<p>Head A: female connector, M16, 8-pin, straight Head B: Flying leads Cable: PUR, halogen-free, shielded, 5 m</p>	YF2Z18-050XXXXLEBX	2026742
	<p>Head A: female connector, M16, 8-pin, straight Head B: Flying leads Cable: PUR, halogen-free, shielded, 10 m</p>	YF2Z18-100XXXXLEBX	2027193
	<ul style="list-style-type: none"> Connection type head A: Female connector, 7/8", 5-pin, straight Signal type: DeviceNet™, CANopen Description: DeviceNet™, terminal resistor, shielded CANopen Permitted cross-section: ≤ 1.5 mm² Note: For field bus technology 	DOS-7805-GKEND	6028329
	<ul style="list-style-type: none"> Connection type head A: Male connector, M12, 4-pin, straight, B-coded Signal type: PROFIBUS DP Description: PROFIBUS DP, terminal resistor 	STE-END-Q	6021156

	Brief description	Type	Part no.
Reflectors			
	Reflector plate, "diamond grade" reflective tape, 665 mm x 665 mm, base plate material: aluminum, screw connection, Screw-on, 4 hole mounting	PL560DG	1016806
Terminal and alignment brackets			
	Alignment unit, stainless steel	BEF-DME alignment bracket	2040695

SICK AT A GLANCE

SICK is one of the leading manufacturers of intelligent sensors and sensor solutions for industrial applications. A unique range of products and services creates the perfect basis for controlling processes securely and efficiently, protecting individuals from accidents and preventing damage to the environment.

We have extensive experience in a wide range of industries and understand their processes and requirements. With intelligent sensors, we can deliver exactly what our customers need. In application centers in Europe, Asia and North America, system solutions are tested and optimized in accordance with customer specifications. All this makes us a reliable supplier and development partner.

Comprehensive services complete our offering: SICK LifeTime Services provide support throughout the machine life cycle and ensure safety and productivity.

For us, that is “Sensor Intelligence.”

WORLDWIDE PRESENCE:

Contacts and other locations –www.sick.com