



Product Compliance

[For compliance documentation, visit the product page on TE.com>](#)

| | |
|---|---|
| EU RoHS Directive 2011/65/EU | Compliant with Exemptions |
| EU ELV Directive 2000/53/EC | Compliant with Exemptions |
| China RoHS 2 Directive MIIT Order No 32, 2016 | Restricted Materials Above Threshold |
| EU REACH Regulation (EC) No. 1907/2006 | <p>Current ECHA Candidate List: JUNE 2022 (224)</p> <p>Candidate List Declared Against: JUNE 2022 (224)</p> <p>SVHC > Threshold:</p> <p>Pb (3.5% in Component Part)</p> <p>Article Safe Usage Statements: Do not eat, drink or smoke when using this product. Wash thoroughly after handling. Recycle if possible and dispose of the article by following all applicable governmental regulations relevant to your geographic location.</p> |
| Halogen Content | Low Halogen - Br, Cl, F, I < 900 ppm per homogenous material. Also BFR/CFR/PVC Free |
| Solder Process Capability | Not reviewed for solder process capability |

Product Compliance Disclaimer

This information is provided based on reasonable inquiry of our suppliers and represents our current actual knowledge based on the information they provided. This information is subject to change. The part numbers that TE has identified as EU RoHS compliant have a maximum concentration of 0.1% by weight in homogenous materials for lead, hexavalent chromium, mercury, PBB, PBDE, DBP, BBP, DEHP, DIBP, and 0.01% for cadmium, or qualify for an exemption to these limits as defined in the Annexes of Directive 2011/65/EU (RoHS2). Finished electrical and electronic equipment products will be CE marked as required by Directive 2011/65/EU. Components may not be CE marked. Additionally, the part numbers that TE has identified as EU ELV compliant have a maximum concentration of 0.1% by weight in homogenous materials for lead, hexavalent chromium, and mercury, and 0.01% for cadmium, or qualify for an exemption to these limits as defined in the Annexes of Directive 2000/53/EC (ELV). Regarding the REACH Regulation, the information TE provides on SVHC in articles for this part number is based on the latest European Chemicals Agency (ECHA) 'Guidance on requirements for substances in articles' posted at this URL: <https://echa.europa.eu/guidance-documents/guidance-on-reach>

Compatible Parts

| | | | |
|---|---|--|---|
| <p>TE Part # 1SNA166928R2000</p> <p>KEM-1</p> | <p>TE Part # 1SNA166962R0000</p> <p>KEM-3</p> | <p>TE Part # 1SNA167496R1100</p> <p>PCVA</p> | <p>TE Part # 1SNA167680R0500</p> <p>BJ-VL</p> |
|---|---|--|---|

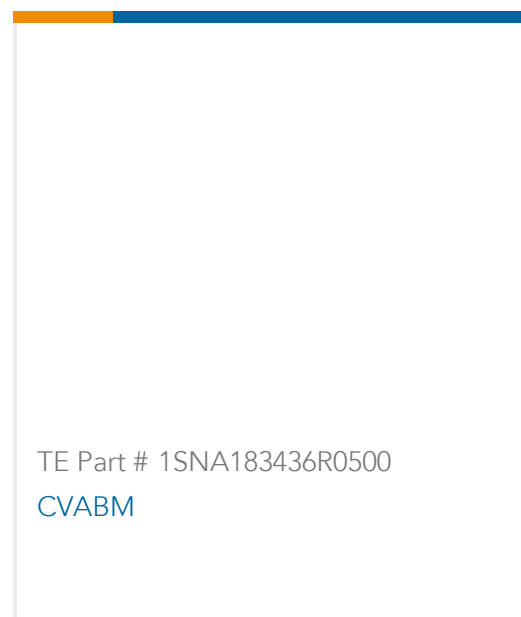
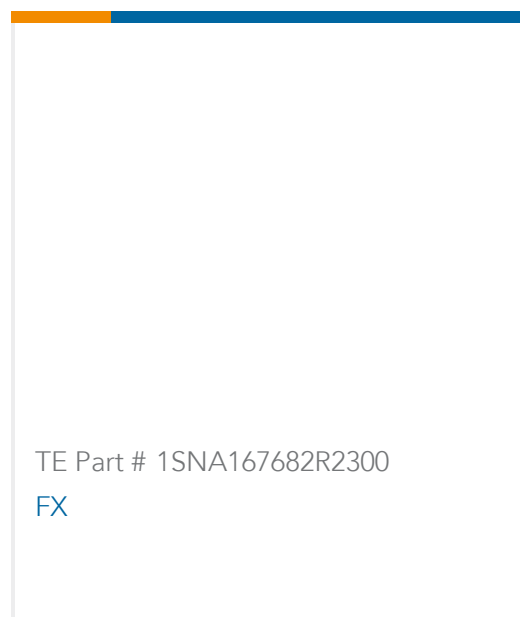
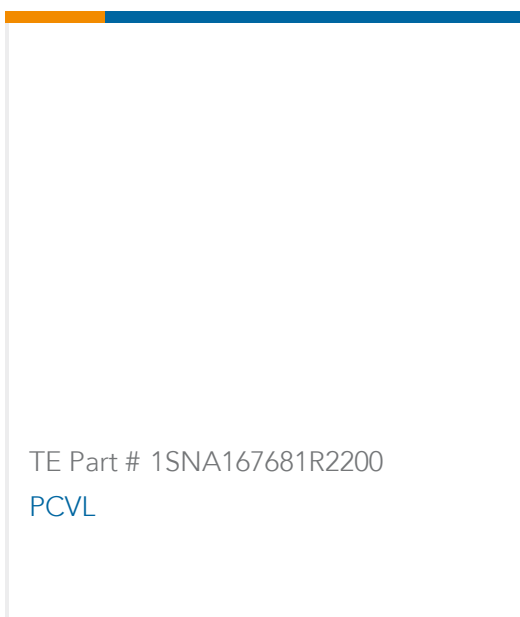

Customers Also Bought

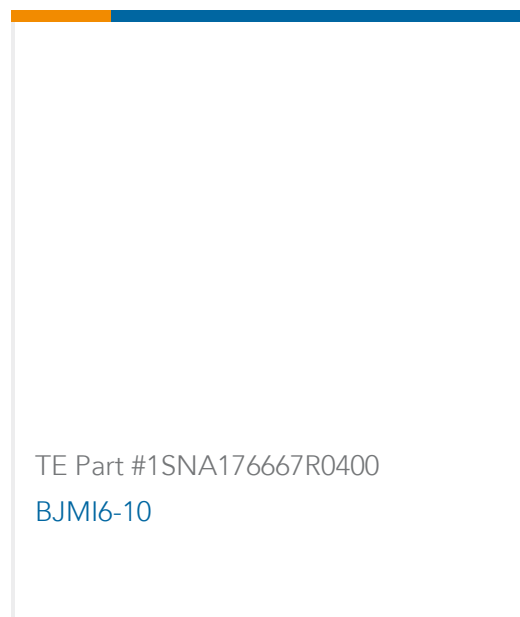
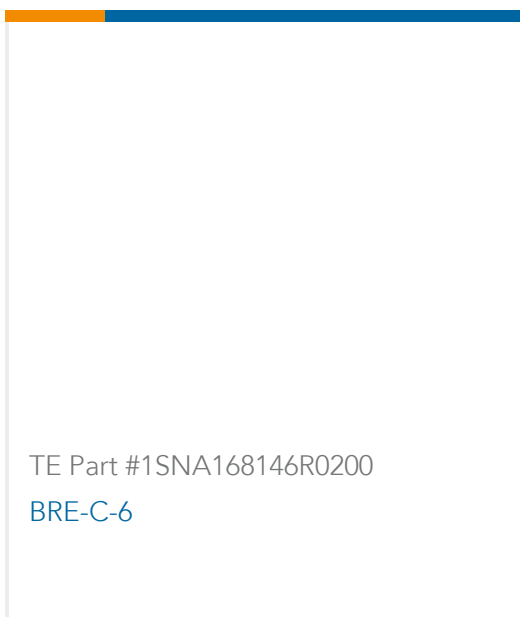
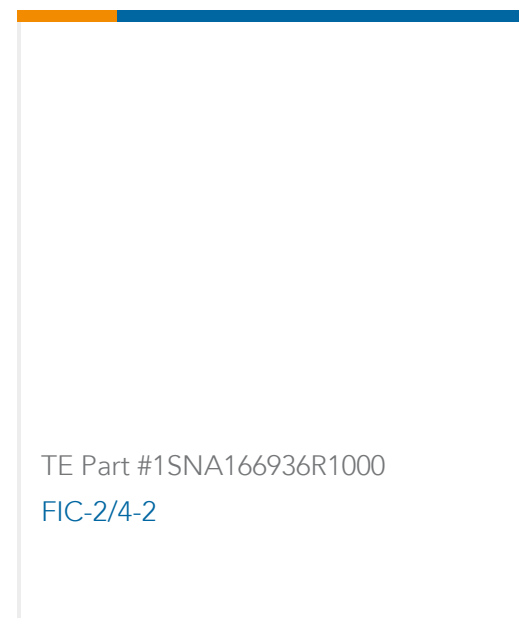
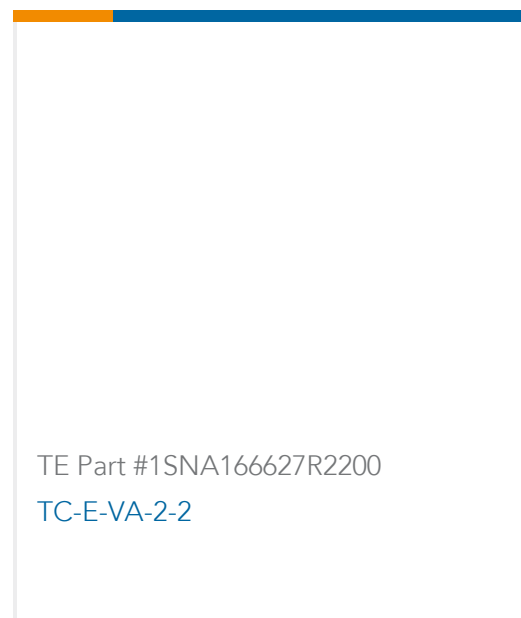
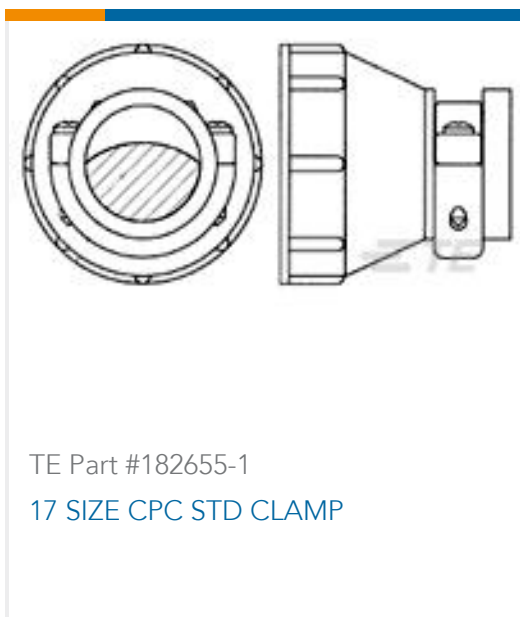

Documents

Product Drawings

CC-E-VA-R2-6.6

French

Datasheets & Catalog Pages

ESSAILEC Test Blocks

French

ESSAILEC Test Blocks Catalogue

English



[ESSAILEC Test Blocks Catalogue](#)

German

[CC-E-VA-R2-6.6](#)

English

[ENTRELEC Terminal Block - Master Catalog](#)

English

[ENTRELEC Terminal Blocks Catalogue \(RUS\)](#)