



i15-EP0123 Lock

i15 Lock

SAFETY LOCKING DEVICES

SICK
Sensor Intelligence.



Ordering information

Type	Part no.
i15-EP0123 Lock	6034030

The actuator has to be ordered separately. See "Accessories" for further details.

Other models and accessories → www.sick.com/i15_Lock

actuator not supplied with delivery



Detailed technical data

Features

Sensor principle	Electro-mechanical
Locking principle	Power to lock
Number of positive action N/C solenoid monitoring contacts	1
Number of N/O solenoid monitoring contacts	0
Number of positive action N/C door monitoring contacts	2
Number of N/O door monitoring contacts	0
Number of N/C door monitoring contacts	0
Locking force F_{max}	1,000 N (EN ISO 14119)
Locking force F_{Zh}	700 N (EN ISO 14119)
Actuation force	≥ 35 N
Retaining force	≤ 30 N
Actuation frequency	≤ 7,000 /h
Actuation directions	4
Approach speed	≤ 20 m/min

Safety-related parameters

B_{10d} parameter	2×10^6 switching cycles (with small load)
Type	Type 2 (EN ISO 14119)
Actuator coding level	Low coding level (EN ISO 14119)
Safe state in the event of a fault	The switch has no internal fault detection and is unable to assume a safe state in the event of a fault. Fault detection is performed by the connected safety-related logic unit.

Functions

Safe series connection	None, only individual wiring (with diagnostics)
-------------------------------	---

Interfaces

Connection type	Cable gland, 1 x M20
Conductor cross section	0.34 mm ² ... 1.5 mm ²

Electrical data

Contamination rating	3
Switching principle	Slow action switching element
Usage category	AC-15/DC-13 (IEC 60947-5-1)
Rated operating current (voltage)	4 A (230 V AC) 4 A (24 V DC)
Rated insulation voltage U_i	250 V
Rated impulse withstand voltage U_{imp}	2,500 V
Type of output	Electro-mechanical contacts
Power consumption	≤ 6 W
Short-circuit protection	4 A gG
Switching voltage	≥ 12 V DC
Switching current (switching voltage)	≥ 1 mA (24 V DC)
Solenoid operating voltage	(20.4 V DC ... 26.4 V DC)
Switch-on time of magnet	100 %
Locking principle	Power to lock

Mechanical data

Weight	0.45 kg
Housing material	Glass-fiber reinforced thermoplastic
Actuator head material	Plastic
Mechanical life	2 x 10 ⁶ switching cycles

Ambient data

Enclosure rating	IP67
Ambient operating temperature	-20 °C ... +55 °C
Storage temperature	-20 °C ... +55 °C

Classifications

ECLASS 5.0	27272603
ECLASS 5.1.4	27272603
ECLASS 6.0	27272603
ECLASS 6.2	27272603
ECLASS 7.0	27272603
ECLASS 8.0	27272603
ECLASS 8.1	27272603
ECLASS 9.0	27272603
ECLASS 10.0	27272603
ECLASS 11.0	27272603
ECLASS 12.0	27272603
ETIM 5.0	EC002593

i15-EP0123 Lock | i15 Lock

SAFETY LOCKING DEVICES

ETIM 6.0	EC002593
ETIM 7.0	EC002593
ETIM 8.0	EC002593
UNSPSC 16.0901	39122205

Dimensional drawing (Dimensions in mm (inch))

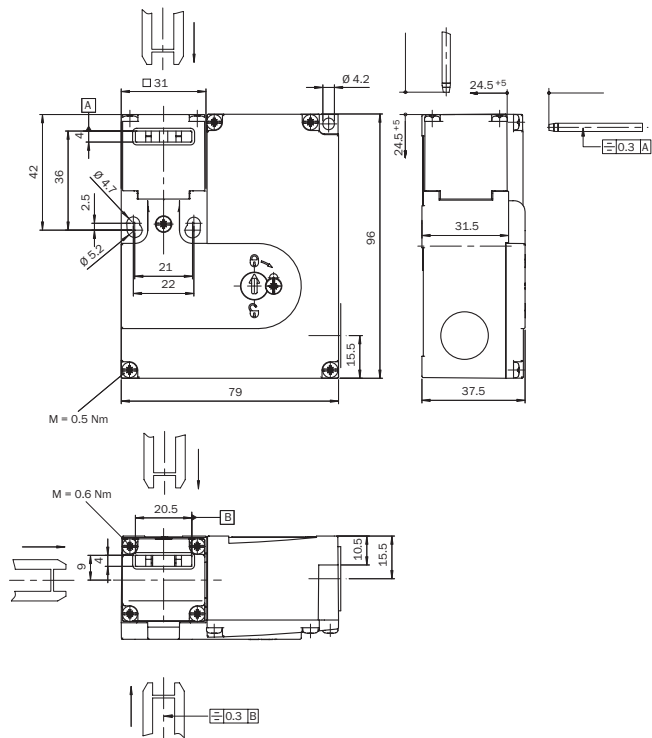

Switching elements

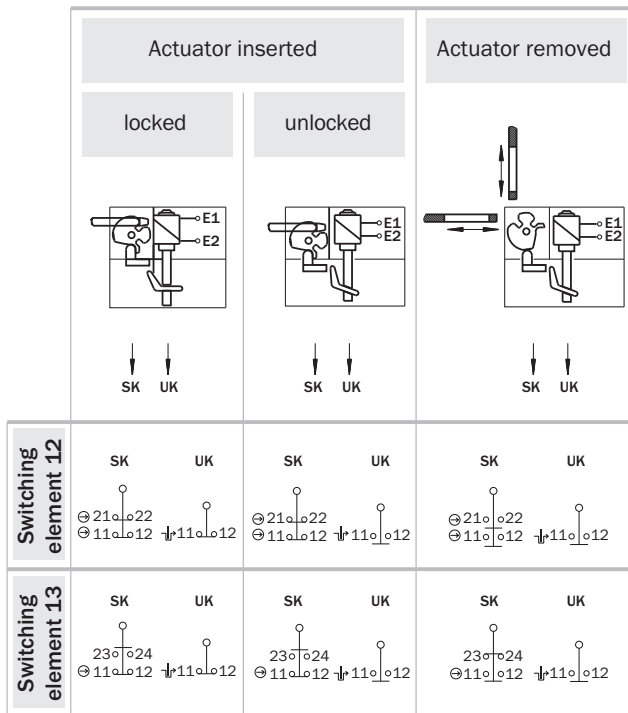

⇩ Positive action N/C locking monitoring contact
⊖ Positive action N/C door monitoring contact

UK: Locking monitoring contacts

SK: Door monitoring contacts

Switching element 12:

- 1 positive action N/C contact (Locking monitoring)
- 2 positive action N/C contacts (Door monitoring)

Switching element 13:

- 1 positive action N/C contact (Locking monitoring)
- 1 positive action N/C contact + 1 N/O contact (Door monitoring)

SICK AT A GLANCE

SICK is one of the leading manufacturers of intelligent sensors and sensor solutions for industrial applications. A unique range of products and services creates the perfect basis for controlling processes securely and efficiently, protecting individuals from accidents and preventing damage to the environment.

We have extensive experience in a wide range of industries and understand their processes and requirements. With intelligent sensors, we can deliver exactly what our customers need. In application centers in Europe, Asia and North America, system solutions are tested and optimized in accordance with customer specifications. All this makes us a reliable supplier and development partner.

Comprehensive services complete our offering: SICK LifeTime Services provide support throughout the machine life cycle and ensure safety and productivity.

For us, that is “Sensor Intelligence.”

WORLDWIDE PRESENCE:

Contacts and other locations –www.sick.com