

# EES37-OKFOA017A

EES/EEM37

MOTOR FEEDBACK SYSTEMS ROTARY HIPERFACE DSL®

**SICK**  
Sensor Intelligence.

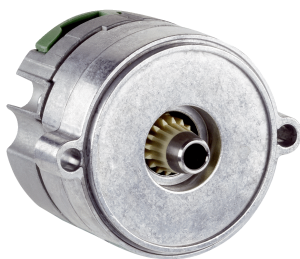

### Ordering information

Type	Part no.
EES37-0KF0A017A	1068811

Other models and accessories → [www.sick.com/EES\\_EEM37](http://www.sick.com/EES_EEM37)

Illustration may differ



### Detailed technical data

#### Performance

<b>Position</b>		
Resolution per revolution		17 bit
System accuracy		± 240 " , ± 160 " , nominal position, 25 °C, filter setting 21 kHz, Nominal position, 25 °C, filter setting 1 kHz <sup>1) 1)</sup>
Signal noise (σ)		± 20 " (nominal position, 25 °C, filter setting 21 kHz)
Number of the absolute ascertainable revolutions		1
Available memory area		8,192 Byte
Measurement step per revolution		131,072

<sup>1)</sup> See diagram for error limits (default filter setting: 21 kHz).

#### Interfaces

<b>Code sequence</b>	Increasing, when turning the shaft For clockwise rotation, looking in direction "A" (see dimensional drawing)
<b>Communication interface</b>	HIPERFACE DSL®
<b>Initialization time</b>	Max. 500 ms <sup>1)</sup>
<b>Measurement external temperature resistance</b>	32-bit value, without prefix (1 Ω) 0 ... 209.600 Ω <sup>2)</sup>

<sup>1)</sup> From reaching a permitted operating voltage.

<sup>2)</sup> Without sensor tolerance; at -17 °C ... +167 °C: NTC +2K (103 GT); PTC+3K (KTY84/130/PT1000).

#### Electrical data

<b>Connection type</b>	Male connector, 4-pin
<b>Supply voltage</b>	7 V ... 12 V
<b>Warm-up time voltage ramp</b>	Max. 180 ms <sup>1)</sup>
<b>Current consumption</b>	≤ 150 mA <sup>2)</sup>
<b>MTTF: mean time to dangerous failure</b>	170 years (EN ISO 13849) <sup>3)</sup>

<sup>1)</sup> Duration of the voltage ramp between 0 and 7.0 V, see diagram "Current consumption" in the diagram section.

<sup>2)</sup> Current rating applies when using interface circuit suggestions as shown in HIPERFACE DSL® manual (8017595).

<sup>3)</sup> This product is a standard product and does not constitute a safety component as defined in the Machinery Directive. Calculation based on nominal load of components, average ambient temperature 60 °C, frequency of use 8760 h/a. All electronic failures are considered hazardous. For more information, see document no. 8015532.

## Mechanical data

<b>Shaft version</b>	Tapered shaft
<b>Dimensions</b>	See dimensional drawing
<b>Centering collar</b>	Standard 1.5 mm
<b>Weight</b>	≤ 0.1 kg
<b>Moment of inertia of the rotor</b>	1 gcm <sup>2</sup>
<b>Operating speed</b>	≤ 12,000 min <sup>-1</sup>
<b>Angular acceleration</b>	≤ 500,000 rad/s <sup>2</sup>
<b>Permissible radial shaft movement</b>	± 0.15 mm
<b>Permissible axial shaft movement</b>	± 0.5 mm

## Ambient data

<b>Operating temperature range</b>	-40 °C ... +115 °C <sup>1)</sup>
<b>Storage temperature range</b>	-40 °C ... +120 °C, without package
<b>Relative humidity/condensation</b>	85 %, Condensation not permitted
<b>Resistance to shocks</b>	100 g, 6 ms (according to EN 60068-2-27)
<b>Frequency range of resistance to vibrations</b>	50 g, 10 Hz ... 2,000 Hz (EN 60068-2-6)
<b>EMC</b>	According to EN 61000-6-2: 2016, EN 61000-6-4: 2006, IEC 6100-6-7: 2014 <sup>2)</sup>
<b>Enclosure rating</b>	IP30, When cover is closed and mating connector is attached (IEC 60529-1) <sup>3)</sup>

<sup>1)</sup> For typical values for self-heating, see diagram "Electrical self-heating" in the diagram section. see section "Mounting" in the operating instructions (8021414/8021265).

<sup>2)</sup> According to the listed standards, EMC is guaranteed if the motor feedback system with mating connector inserted is connected to the central grounding point of the motor controller via a cable shield. If other shielding concepts are used, users must perform their own tests. Class A device.

<sup>3)</sup> When using the strands (2079920).

## Classifications

<b>ECLASS 5.0</b>	27270590
<b>ECLASS 5.1.4</b>	27270590
<b>ECLASS 6.0</b>	27270590
<b>ECLASS 6.2</b>	27270590
<b>ECLASS 7.0</b>	27270590
<b>ECLASS 8.0</b>	27270590
<b>ECLASS 8.1</b>	27270590
<b>ECLASS 9.0</b>	27270590
<b>ECLASS 10.0</b>	27273805
<b>ECLASS 11.0</b>	27273901
<b>ECLASS 12.0</b>	27273901
<b>ETIM 5.0</b>	EC001486
<b>ETIM 6.0</b>	EC001486
<b>ETIM 7.0</b>	EC001486
<b>ETIM 8.0</b>	EC001486
<b>UNSPSC 16.0901</b>	41112113

### Dimensional drawing (Dimensions in mm (inch))

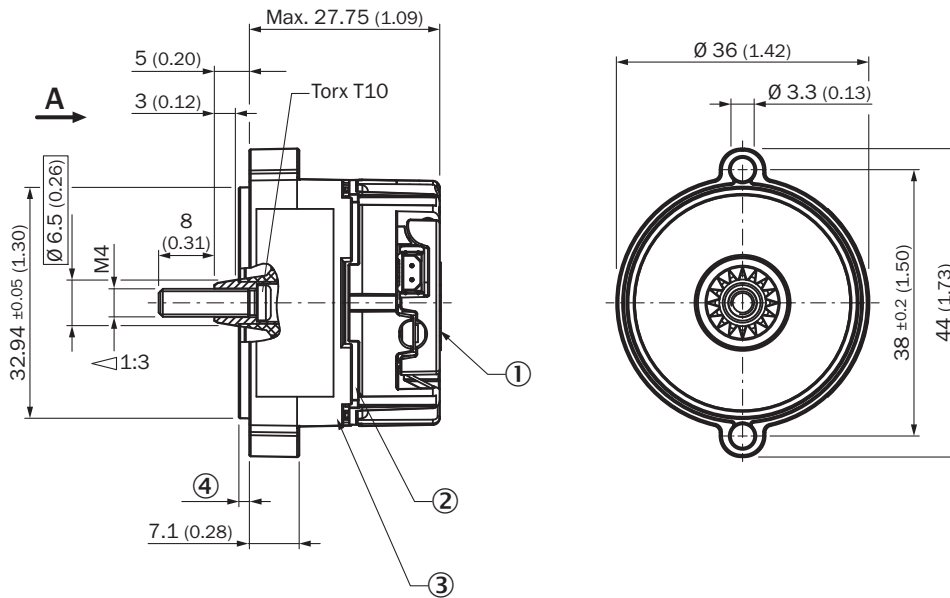

Screw M4 not included (see under accessories)

- ① Measuring point for vibrations
- ② Design-related gap
- ③ Measuring point for operating temperature
- ④ Centering collar: Standard 1.5 mm; reduced 0.7 mm

### Attachment specifications

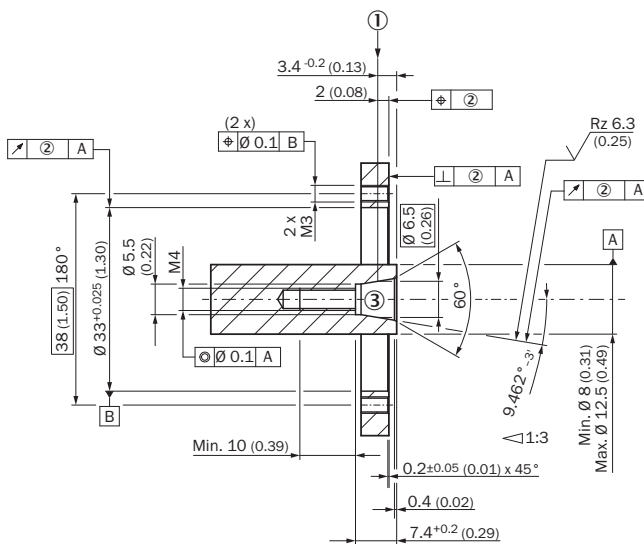

Read out axial position: positive value shows movement of rotor away from the motor flange; negative value shows movement of rotor towards the motor flange

- ① Nominal position
- ② The size of the tolerance reduces the permissible wave movement, see data sheet
- ③ Threaded holes in accordance with DIN 13 with recesses in accordance with DIN 76 min. 1.05 x thread diameter

### PIN assignment

Supply / Communication pin assignment

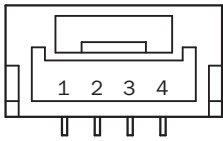

Integrated in motor cable = J, K

PIN	Signal	Explanation
1		Not connected - no function
2	+U <sub>S</sub> /DSL+	Supply 7 V ... 12 V
3	GND/DSL-	Ground connection
4		Not connected - no function
Recommended outer diameter of set of stranded wires: 4 mm +0/-1.5 mm		
Recommended mating connector: JST (GHR-04V-S)		

Temperature sensor pin assignment

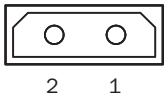

PIN	Signal	Explanation
1	T+	Thermistor connection
2	T-	Thermistor connection (to ground)
Recommended outer diameter of set of stranded wires: 2.2 mm ± 0.1 mm		
Recommended mating connector: Harwin M80-8990205		

### Diagrams

Power consumption

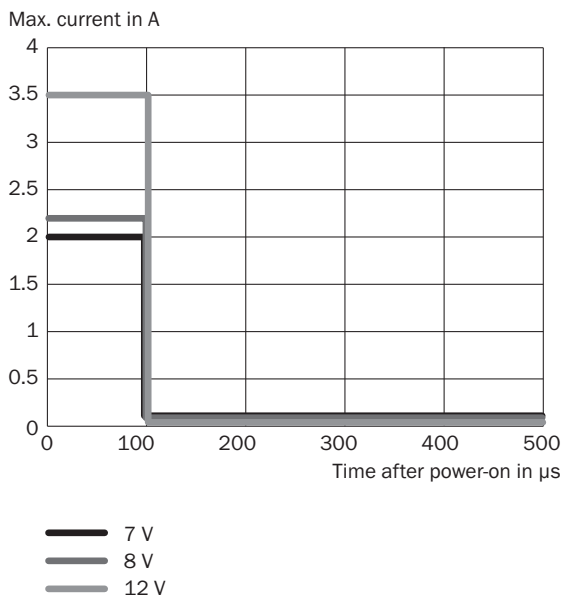

This diagram shows the switch-on current Latency vs. filter frequency

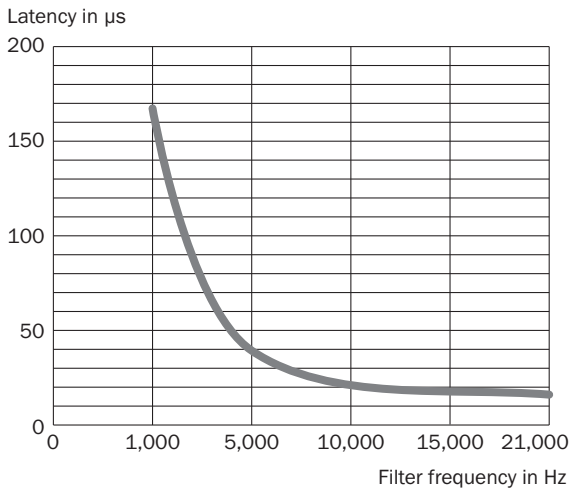

Adjustable filter frequencies 21 kHz, 15 kHz, 10 kHz, 5 kHz and 1 kHz - Default setting 21 kHz  
Error limits

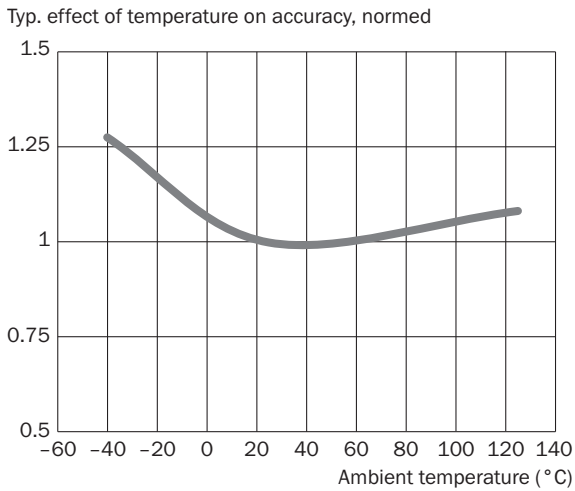

Error limits

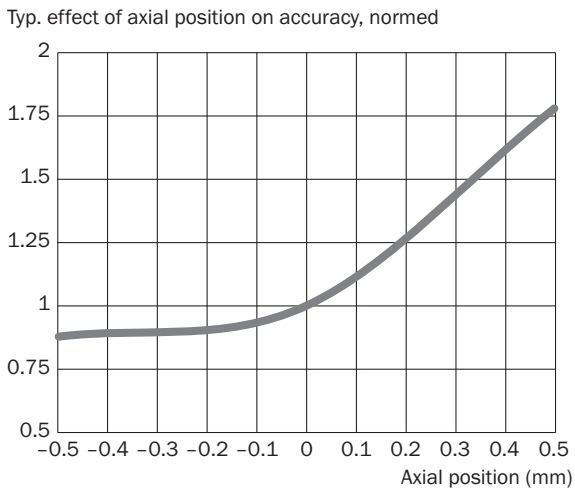

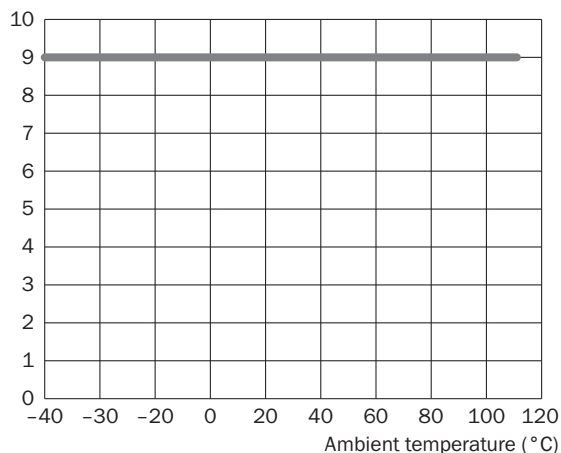

Electrical self-heating

Typ. electrical self-heating, kelvin (K)



Recommended accessories

Other models and accessories → [www.sick.com/EES\\_EEM37](http://www.sick.com/EES_EEM37)

	Brief description	Type	Part no.
<b>Nuts and screws</b>			
	100 pieces, Screws with Precote 85-8 coating; M4*14	BEF-MK-S03	2077358
	10 pieces, Screws with Precote 85-8 coating; M4*14	BEF-MK-S07	2088239
	500 pieces, Screws with Precote 85-8 coating; M4*14	BEF-MK-S08	2088240
<b>Other mounting accessories</b>			
	BEF-MW-PL	BEF-MW-PL	2084768
<b>Plug connectors and cables</b>			
	<ul style="list-style-type: none"> <li>• <b>Connection type head A:</b> Female connector, stranded wire, 4-pin, straight</li> <li>• <b>Connection type head B:</b> Flying leads</li> <li>• <b>Signal type:</b> HIPERFACE DSL®</li> <li>• <b>Cable:</b> 0.2 m, 2-wire</li> <li>• <b>Description:</b> HIPERFACE DSL®, unshielded</li> </ul>	DOL-0B02-G0M2XC2	2079920

## SICK AT A GLANCE

SICK is one of the leading manufacturers of intelligent sensors and sensor solutions for industrial applications. A unique range of products and services creates the perfect basis for controlling processes securely and efficiently, protecting individuals from accidents and preventing damage to the environment.

We have extensive experience in a wide range of industries and understand their processes and requirements. With intelligent sensors, we can deliver exactly what our customers need. In application centers in Europe, Asia and North America, system solutions are tested and optimized in accordance with customer specifications. All this makes us a reliable supplier and development partner.

Comprehensive services complete our offering: SICK LifeTime Services provide support throughout the machine life cycle and ensure safety and productivity.

For us, that is “Sensor Intelligence.”

## WORLDWIDE PRESENCE:

Contacts and other locations –[www.sick.com](http://www.sick.com)