



WL34-B430

W34

COMPACT PHOTOELECTRIC SENSORS

SICK
Sensor Intelligence.



Illustration may differ



Ordering information

Type	Part no.
WL34-B430	1019245

Other models and accessories → www.sick.com/W34

Detailed technical data

Features

Functional principle	Photoelectric retro-reflective sensor
Functional principle detail	Dual lens
Dimensions (W x H x D)	27 mm x 92 mm x 70 mm
Housing design (light emission)	Rectangular
Sensing range max.	0.03 m ... 22 m ¹⁾
Sensing range	0.03 m ... 15 m ¹⁾
Type of light	Visible red light
Light source	LED ²⁾
Light spot size (distance)	Ø 250 mm (15 m)
Wave length	660 nm
Adjustment	Potentiometer

¹⁾ Reflector PL80A.

²⁾ Average service life: 100,000 h at T_J = +25 °C.

Mechanics/electronics

Supply voltage U_B	10 V DC ... 30 V DC ¹⁾
Ripple	< 5 V _{pp} ²⁾
Current consumption	50 mA
Switching output	NPN, PNP

¹⁾ Limit values.

²⁾ May not exceed or fall below U_v tolerances.

³⁾ Signal transit time with resistive load.

⁴⁾ With light/dark ratio 1:1.

⁵⁾ A = V_S connections reverse-polarity protected.

⁶⁾ C = interference suppression.

⁷⁾ D = outputs overcurrent and short-circuit protected.

⁸⁾ Reference voltage: 50 V DC.

Switching mode	Light switching, Dark switching
Switching mode selector	Selectable via PNP/NPN selector
Output current I_{max}	≤ 100 mA
Response time	≤ 500 μs ³⁾
Switching frequency	1,000 Hz ⁴⁾
Connection type	Male connector M12, 4-pin
Circuit protection	A ⁵⁾ C ⁶⁾ D ⁷⁾
Protection class	II ⁸⁾
Weight	140 g
Polarisation filter	✓
Housing material	Plastic, ABS
Enclosure rating	IP67
Test input sender off	TE to 0 V
Ambient operating temperature	-40 °C ... +60 °C
Ambient temperature, storage	-40 °C ... +75 °C
UL File No.	NRKH.E181493 & NRKH7.E181493

1) Limit values.

2) May not exceed or fall below U_v tolerances.

3) Signal transit time with resistive load.

4) With light/dark ratio 1:1.

5) A = V_S connections reverse-polarity protected.

6) C = interference suppression.

7) D = outputs overcurrent and short-circuit protected.

8) Reference voltage: 50 V DC.

Safety-related parameters

MTTF_D	834 years
DC_{avg}	0 %

Classifications

ECLASS 5.0	27270902
ECLASS 5.1.4	27270902
ECLASS 6.0	27270902
ECLASS 6.2	27270902
ECLASS 7.0	27270902
ECLASS 8.0	27270902
ECLASS 8.1	27270902
ECLASS 9.0	27270902
ECLASS 10.0	27270902
ECLASS 11.0	27270902
ECLASS 12.0	27270902
ETIM 5.0	EC002717

ETIM 6.0	EC002717
ETIM 7.0	EC002717
ETIM 8.0	EC002717
UNSPSC 16.0901	39121528

Dimensional drawing (Dimensions in mm (inch))

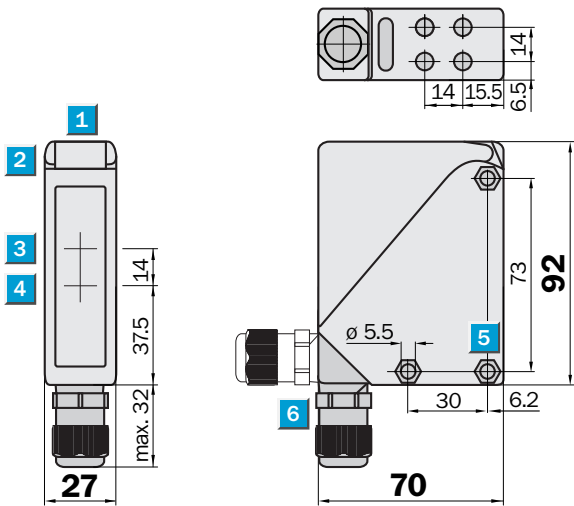

- ① Alignment sight
- ② LED signal strength indicator
- ③ Center of optical axis, sender
- ④ Center of optical axis, receiver
- ⑤ Mounting hole \varnothing 5.5 mm, for M5 hexagon nuts on both sides
- ⑥ M16 screw fixing rotatable by 90°

Adjustments

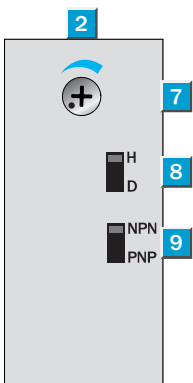

- ② LED signal strength indicator
- ⑦ Sensitivity control
- ⑧ Light/dark selector
- ⑨ NPN/PNP changeover switch

Connection type

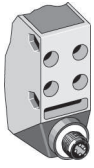

Connection diagram

Cd-117

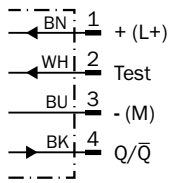

Characteristic curve

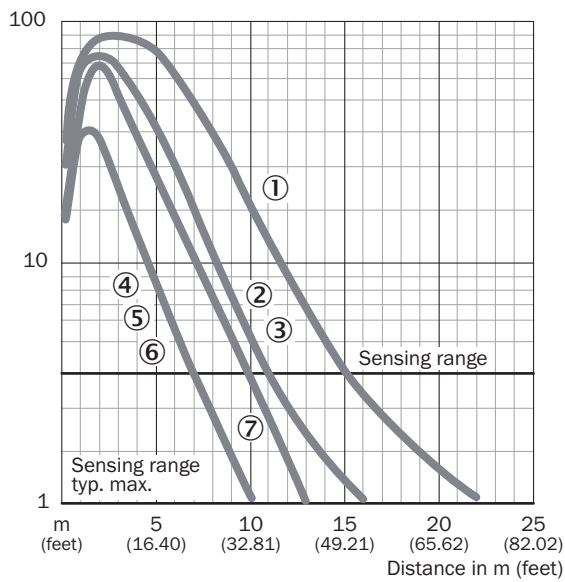

- ① Reflector PL80A
- ② Reflector PL50A
- ③ Reflector PL40A
- ④ Reflector PL30A
- ⑤ Reflector PL20A
- ⑥ Reflective tape Diamond Grade
- ⑦ Reflector C110A



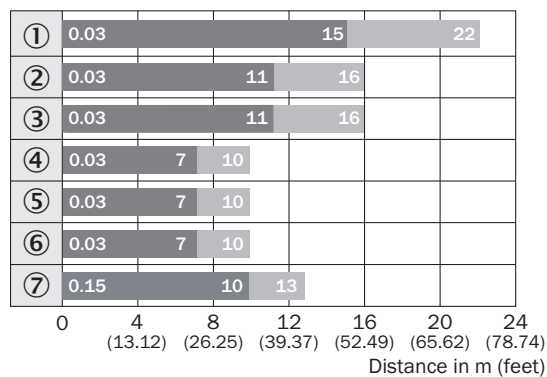

Sensing range diagram



- ① Reflector PL80A
- ② Reflector PL50A
- ③ Reflector PL40A
- ④ Reflector PL30A
- ⑤ Reflector PL20A
- ⑥ Reflective tape Diamond Grade
- ⑦ Reflector C1.10A

Recommended accessories

Other models and accessories → www.sick.com/W34

	Brief description	Type	Part no.
Mounting brackets and plates			
	Universal mounting bracket for reflectors, steel, zinc coated	BEF-WN-REFX	2064574
	Mounting bracket, Stainless steel (1.4301), mounting hardware included	BEF-WN-W24	2015248
Plug connectors and cables			
	<ul style="list-style-type: none"> • Connection type head A: Male connector, M12, 4-pin, straight • Description: Unshielded • Connection systems: Screw-type terminals • Permitted cross-section: ≤ 0.75 mm² 	STE-1204-G	6009932
Reflectors			
	Rectangular, screw connection, 84 mm x 84 mm, PMMA/ABS, Screw-on, 2 hole mounting	PL80A	1003865
Others			
	<ul style="list-style-type: none"> • Connection type head A: Female connector, M12, 4-pin, straight, A-coded • Connection type head B: Flying leads • Signal type: Sensor/actuator cable • Cable: 5 m, 4-wire, PVC • Description: Sensor/actuator cable, unshielded • Application: Zones with chemicals 	YF2A14-050VB3XLEAX	2096235

SICK AT A GLANCE

SICK is one of the leading manufacturers of intelligent sensors and sensor solutions for industrial applications. A unique range of products and services creates the perfect basis for controlling processes securely and efficiently, protecting individuals from accidents and preventing damage to the environment.

We have extensive experience in a wide range of industries and understand their processes and requirements. With intelligent sensors, we can deliver exactly what our customers need. In application centers in Europe, Asia and North America, system solutions are tested and optimized in accordance with customer specifications. All this makes us a reliable supplier and development partner.

Comprehensive services complete our offering: SICK LifeTime Services provide support throughout the machine life cycle and ensure safety and productivity.

For us, that is “Sensor Intelligence.”

WORLDWIDE PRESENCE:

Contacts and other locations –www.sick.com