



GL10-00531S13
G10

SMALL PHOTOELECTRIC SENSORS

SICK
Sensor Intelligence.



Illustration may differ



Ordering information

| Type | Part no. |
|---------------|----------|
| GL10-00531S13 | 1102892 |

Other models and accessories → www.sick.com/G10

Detailed technical data

Features

| | |
|--|---|
| Functional principle | Photoelectric retro-reflective sensor |
| Functional principle detail | Dual lens |
| Dimensions (W x H x D) | 20 mm x 50 mm x 39 mm |
| Housing design (light emission) | Rectangular |
| Sensing range max. | 0.15 m ... 17 m ¹⁾ 0.15 m ... 5 m ²⁾ |
| Sensing range | 0.3 m ... 14 m ¹⁾ 0.3 m ... 4 m ²⁾ |
| Type of light | Visible red light |
| Light source | PinPoint LED ³⁾ |
| Light spot size (distance) | Ø 58 mm (5 m) |
| Wave length | 625 nm |
| Adjustment | None |
| Special features | Test input |

¹⁾ Reflector PL80A.

²⁾ Reflective tape REF-IRF-56.

³⁾ Average service life: 100,000 h at T_J = +25 °C.

Mechanics/electronics

| | |
|--|--|
| Supply voltage | 10 V DC ... 30 V DC ¹⁾ |
| Ripple | < 5 V _{pp} ²⁾ |
| Current consumption | 20 mA |
| Switching output | PNP |
| Switching mode | Light switching |
| Output current I_{max.} | ≤ 1,250 µA |
| Response time | ≤ 1 ms ³⁾ |
| Switching frequency | 400 Hz ⁴⁾ |
| Connection type | Cable with plug M12, 5-pin, 300 mm ⁵⁾ |
| Cable material | PVC |
| Circuit protection | A ⁶⁾ B ⁷⁾ C ⁸⁾ D ⁹⁾ |
| Protection class | III |
| Weight | 70 g |
| Polarisation filter | ✓ |
| Housing material | Plastic, ABS/PMMA |
| Enclosure rating | IP67 |
| Electromagnetic compatibility (EMC) | EN 60947-5-2 |
| Ambient operating temperature | -30 °C ... +60 °C |
| Ambient temperature, storage | -40 °C ... +70 °C |
| UL File No. | NRKH.E348498 & NRKH7.E348498 |
| More standards | UL325 ¹⁰⁾ |

¹⁾ Limit values when operated in short-circuit protected network: max. 8 A.

²⁾ May not exceed or fall below U_v tolerances.

³⁾ Signal transit time with resistive load.

⁴⁾ With light/dark ratio 1:1.

⁵⁾ Do not bend below 0 °C.

⁶⁾ A = V_S connections reverse-polarity protected.

⁷⁾ B = inputs and output reverse-polarity protected.

⁸⁾ C = interference suppression.

⁹⁾ D = outputs overcurrent and short-circuit protected.

¹⁰⁾ Complies with the UL325 standard when used with sturdy protection hood (e.g. BEF-G10WSG, 2071960).

Classifications

| | |
|---------------------|----------|
| eCl@ss 5.0 | 27270902 |
| eCl@ss 5.1.4 | 27270902 |
| eCl@ss 6.0 | 27270902 |
| eCl@ss 6.2 | 27270902 |
| eCl@ss 7.0 | 27270902 |
| eCl@ss 8.0 | 27270902 |
| eCl@ss 8.1 | 27270902 |

| | |
|-----------------------|----------|
| eCl@ss 9.0 | 27270902 |
| eCl@ss 10.0 | 27270902 |
| eCl@ss 11.0 | 27270902 |
| eCl@ss 12.0 | 27270902 |
| ETIM 5.0 | EC002717 |
| ETIM 6.0 | EC002717 |
| ETIM 7.0 | EC002717 |
| ETIM 8.0 | EC002717 |
| UNSPSC 16.0901 | 39121528 |

Connection diagram

Cd-457

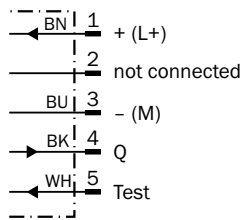

Characteristic curve

GL10, Logistik, DC, GL10G, DC

Operating Reserve

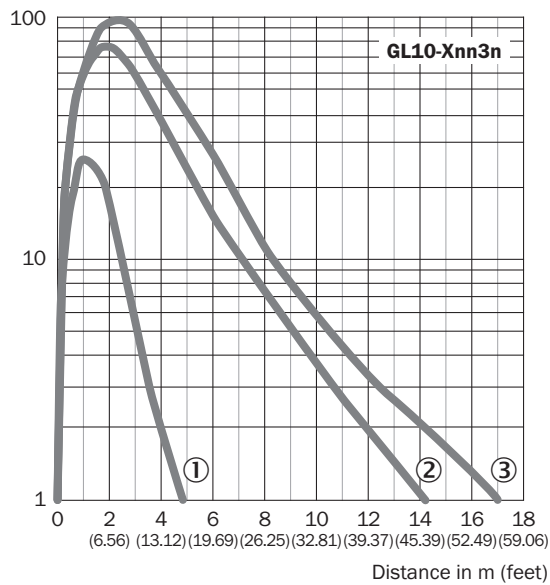

- ① Reflective tape REF-IRF-56
- ② Reflector PL40A
- ③ Reflector PL80A

Light spot size

Light spot size

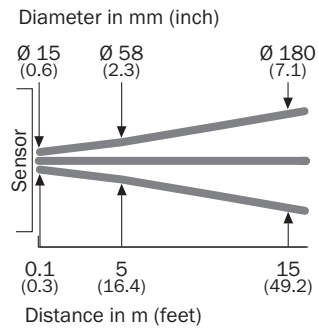

Sensing range diagram

GL10, Logistik, DC, GL10G, DC

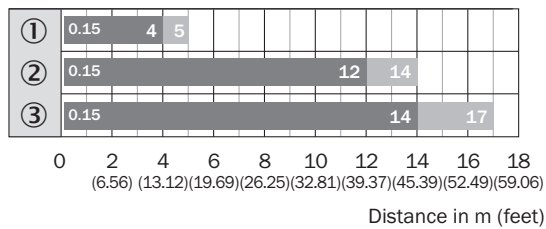

- Sensing range
- Sensing range max.
- ① Reflective tape REF-IRF-56
- ② Reflector PL40A
- ③ Reflector PL80A

Adjustments

GL10, logistics, DC

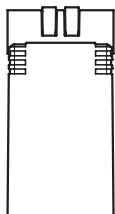

No adjustment possibility

Dimensional drawing (Dimensions in mm (inch))

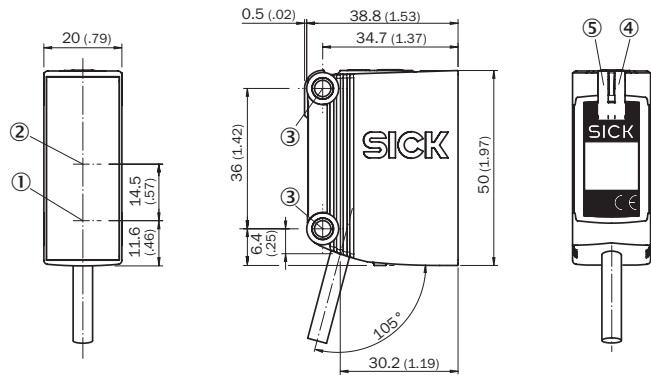

CableGTE10, GL10, GL10G, DC, connector



- ① Center of optical axis, sender
- ② Center of optical axis, receiver
- ③ Mounting hole, Ø 4.2 mm
- ④ LED indicator yellow: Status of received light beam
- ⑤ LED indicator green: power on

Recommended accessories

Other models and accessories → www.sick.com/G10

| | Brief description | Type | Part no. |
|---|--|---------------|----------|
| Universal bar clamp systems | | | |
|  | Q-Lock, bar clamp system for G10 and reflector P250, Die-cast zinc, steel, zinc coated | BEF-KHSQ12R01 | 2071260 |
| Mounting brackets and plates | | | |
|  | Universal mounting bracket for reflectors, steel, zinc coated | BEF-WN-REFX | 2064574 |
| Reflectors | | | |
|  | Rectangular, screw connection, 51 mm x 61 mm, PMMA/ABS, Screw-on, 2 hole mounting | P250 | 5304812 |

SICK AT A GLANCE

SICK is one of the leading manufacturers of intelligent sensors and sensor solutions for industrial applications. A unique range of products and services creates the perfect basis for controlling processes securely and efficiently, protecting individuals from accidents and preventing damage to the environment.

We have extensive experience in a wide range of industries and understand their processes and requirements. With intelligent sensors, we can deliver exactly what our customers need. In application centers in Europe, Asia and North America, system solutions are tested and optimized in accordance with customer specifications. All this makes us a reliable supplier and development partner.

Comprehensive services complete our offering: SICK LifeTime Services provide support throughout the machine life cycle and ensure safety and productivity.

For us, that is “Sensor Intelligence.”

WORLDWIDE PRESENCE:

Contacts and other locations –www.sick.com