

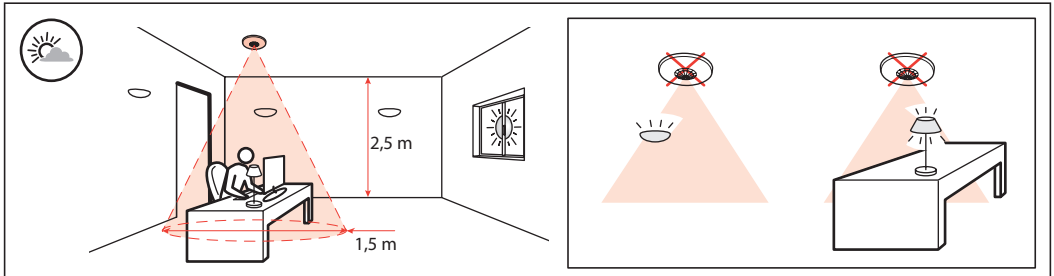

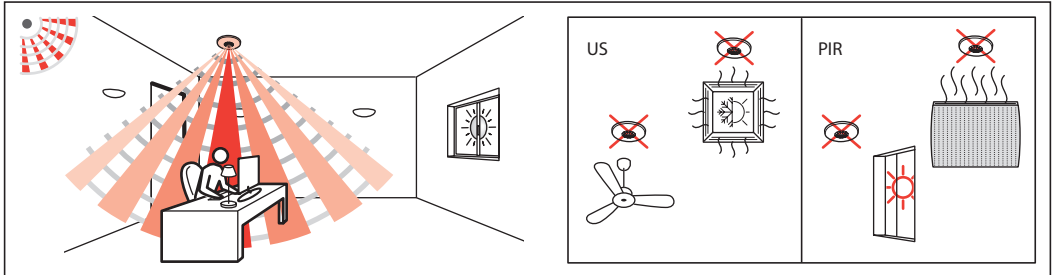

	12-20 V DALI
	25 mA
	RJ45
	-5°C → +45°C
	PIR / ULTRASONIC
	500 lux
	15 mn
	Auto ON/OFF
	Ø 8 m

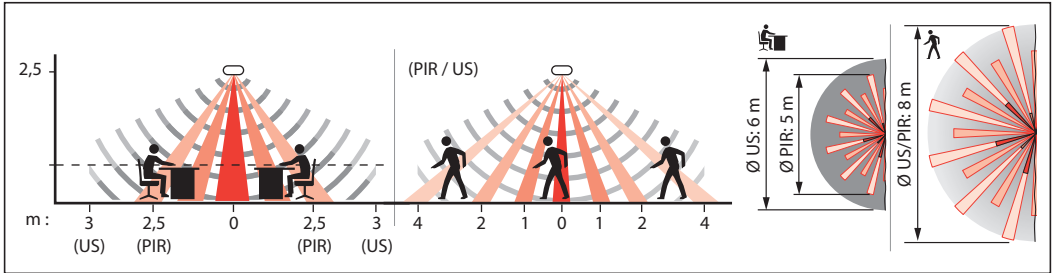

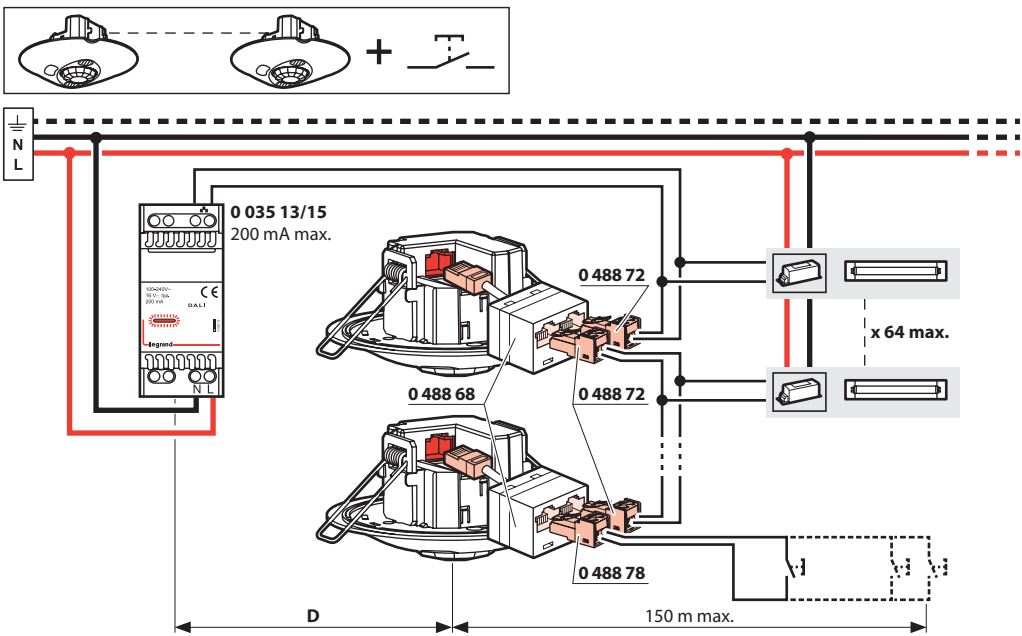
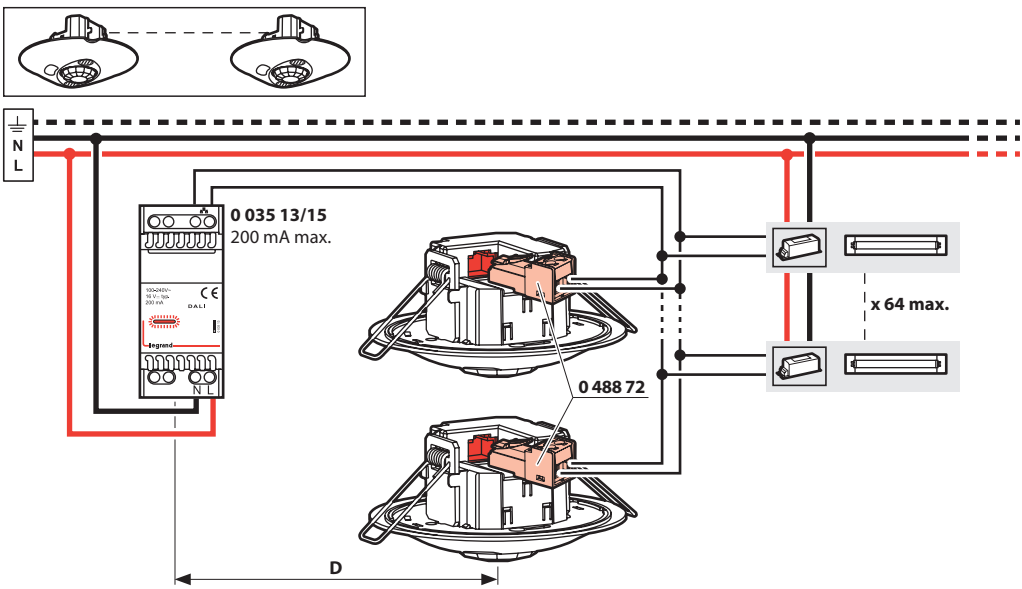



D	
≤ 100 m	0,5 mm ²
≤ 150 m	0,75 mm ²
≤ 300 m	1,5 mm ²

 • Le poussoir est obligatoirement connecté à un détecteur maître à l'aide de la Réf. **0 488 78**.

 +  • Push button must be connected to a master detector through **Cat. No. 0 488 78**.

 → 25 mA

 → 2 mA

Test

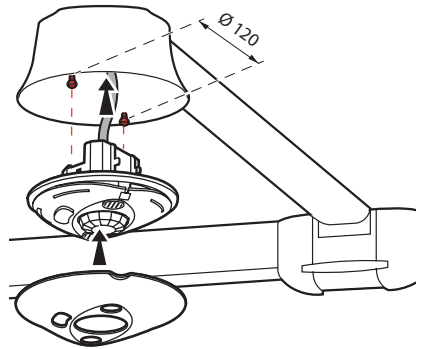
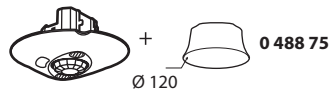
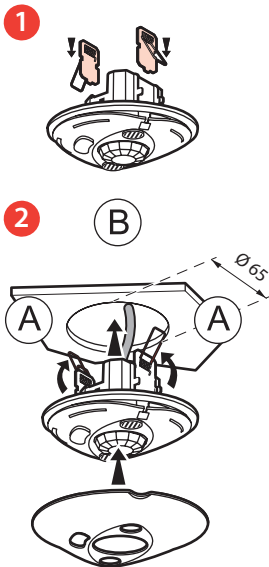
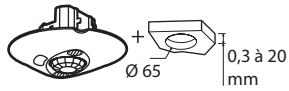
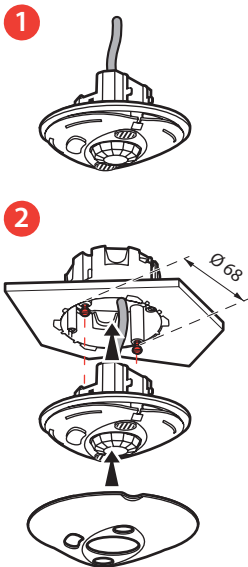
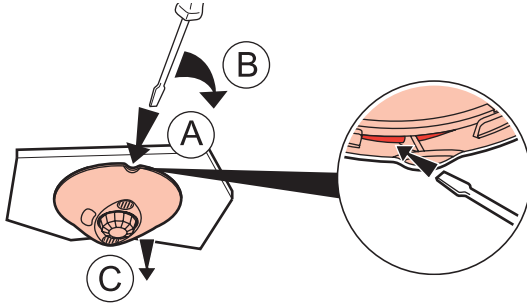
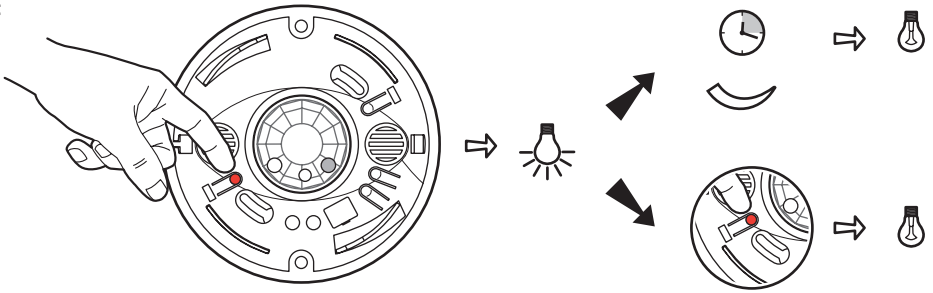



Auto ON/OFF



Manual ON / Auto OFF



- Réf. 0 882 40 : Passerelle de configuration
- Cat. No(s) 0 882 40 : Configuration tool

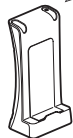

&



Application: «Legrand Close Up»

- À la première utilisation: Télécharger l'application Legrand Close Up sur l' Apple Store ou le Play Store.
- On first use: Download the Legrand Close Up app from Apple Store or Play Store



App Store



Google Play



- Pour plus de renseignement sur les paramètres, reportez vous à la fiche technique de la passerelle de configuration Réf. 0 882 40.
- For more information about setting parameters, refer to the data sheet for the configuration gateway Cat. No. 0 882 40.

	5 - 1275 lux
	5 sec - 2 h
	25% - 50% - 75% - 100%
Mode	Auto ON/OFF - Manual On/Auto OFF - Walkthrough

- Capteur US
- US sensor
- LED de détection
- Motion LED

- Bouton de TEST
- TEST button

- LED Rouge Configuration DALI
- DALI Configuration RED LED

