



Product designation	Solid state relay		
Product type designation	HS1C		
Type	single-phase		
Input characteristics			
Control voltage	90...280VAC		
Operating voltage limits	Operating voltage pick-up	V	45
	Operating voltage drop-out	V	20
Input current at min...max voltage	mA	90...280VAC	
Operating times			
Switching-on	Half cycle max		
Switching-off	Half cycle max		
Output characteristics			
Switching mode	Zero crossing		
Rated operating voltage	VAC	48...600	
Blocking voltage	V	1200	
Operational frequency (min...max)	Hz	45...65	
Rated operating current AC-51 (resistive load) at 40°C	A	40	
Rated operating current AC-51 (resistive load) at 55°C	A	32	
Operational current min	A	0.165	
Non repetitive surge peak on state current t=10ms	A	520	
Off state leakage current	mA	1	
On state output voltage drop	V	1.2	
Critical rate of rise of off-state voltage dv/dt	V/μs	1000	
Input - Output isolation	V	5000	
Input - Output to metal base	V	5000	
Output protection type	VDR		
I ² t	A ² s	1350	
Terminal characteristics			
Control terminals	Type	Screw	
Terminals tool	Blade 3.5mm		
Tightening torque control terminals	Nm	0.5Nm	
	Ibin	4.5	
Conductor section connectable (control terminals) with 1 or 2 wires min...max	AWG stranded	n°	28...12
	Flexible w/o lug	mm ²	0.75...2.5
	Flexible c/w insulated spade lug	mm ²	0.75...2.5
Load terminals	Type	Screw	
Load terminals tool	PH2		
Tightening torque load terminals	Nm	1.5	
	Ibin	13.3	
Conductor section connectable (load terminals) with 1 or 2 wires min...max	AWG stranded	n°	18...10

Flexible w/o lug	mm ²	1...6
Flexible c/w insulated spade lug	mm ²	1...16

Operating position	allowable	On vertical plane
Fixing		Screw or on 35mm DIN rail

Ambient conditions

Temperature	Operating temperature	min	°C	-40
		max	°C	+80
	Storage temperature	min	°C	-40
		max	°C	+130

Dimensions

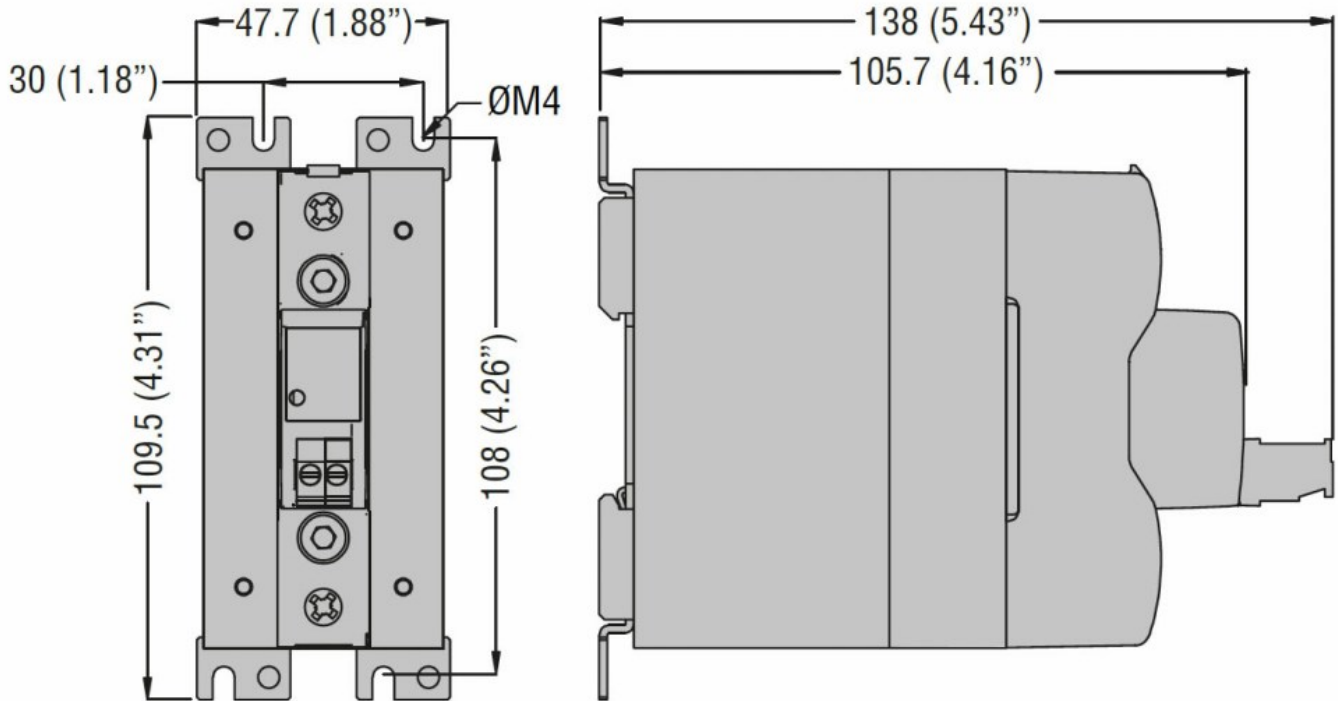

Certifications and compliance

Certifications	IEC/EN/BS 60947-4-2
	IEC/EN/BS 60947-4-3
	IEC/EN/BS 62314
	IEC/EN/BS 6335-1

Compliance	cULus
------------	-------

ETIM classification

EC000066 - Power contactor, AC switching