



Current
transformers
DM5TP1000
Solid-core

Product designation

Product type designation

Type of CT

Current inputs

Primary current I_{pn} (/5)	A	1000
Operational frequency	min	Hz 50
	max	Hz 60
Secondary output current	A	5
Overload withstand I_{pn}	%	120
Burden	cl. 0.5s	VA 5
	cl. 0.5	VA 10

Insulations

Rated insulation voltage U_i IEC/EN	V	720
IEC rated short-time thermal current I_{th}	I_{th} for s	40...60
IEC rated dynamic current I_{dyn}	I_{th} for s	2.5
Insulation dry type		Class E

Mechanical features

Terminals type	Screw
Fixing	DIN rail or by Screw
Weight	g 900

Ambient conditions

Temperature	Operating temperature	min	°C	-25
		max	°C	+50
Storage temperature	min	°C	-40	
	max	°C	+80	
Relative humidity		%	90	
Protection degree			IP30	

Dimensions

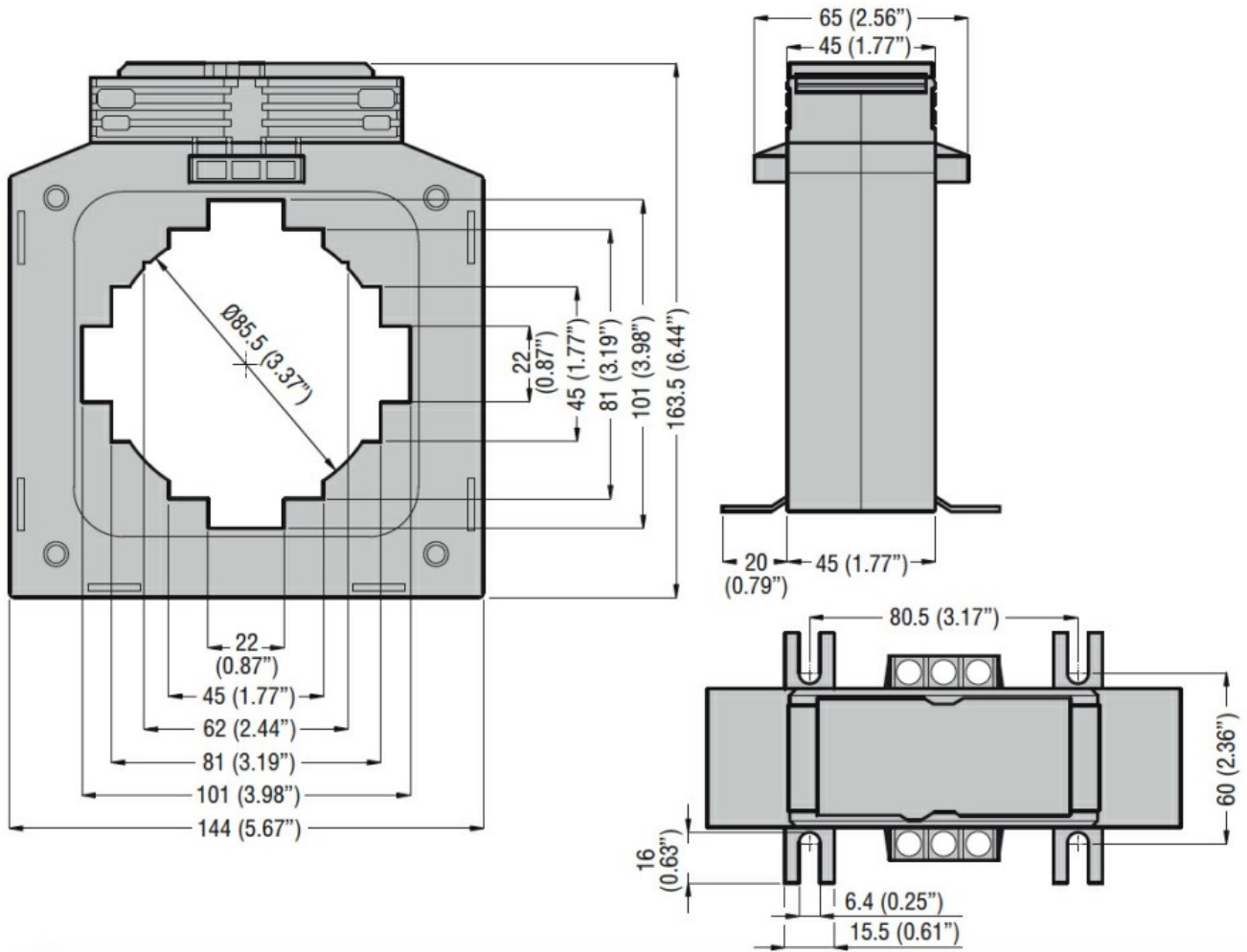

Certifications and compliance

Certifications

IEC/EN/BS 61869-1

IEC/EN/BS 61869-2

Compliance

EAC

ETIM classification

EC000066 - Power contactor, AC switching

□