



Product designation

Changeover
contactor
assemblies
BFC

Product type designation

Electrical features

Maximum operating current ($\leq 440V$)

A 115

Contact characteristics

Operational current Ie

AC-1 ($\leq 40^{\circ}C$)	A	115
AC-1 ($\leq 55^{\circ}C$)	A	95
AC-1 ($\leq 60^{\circ}C$)	A	80

Mechanical features

Terminals type

Screw

Fixing

Side mount

Weight

g 2532

Dimensions

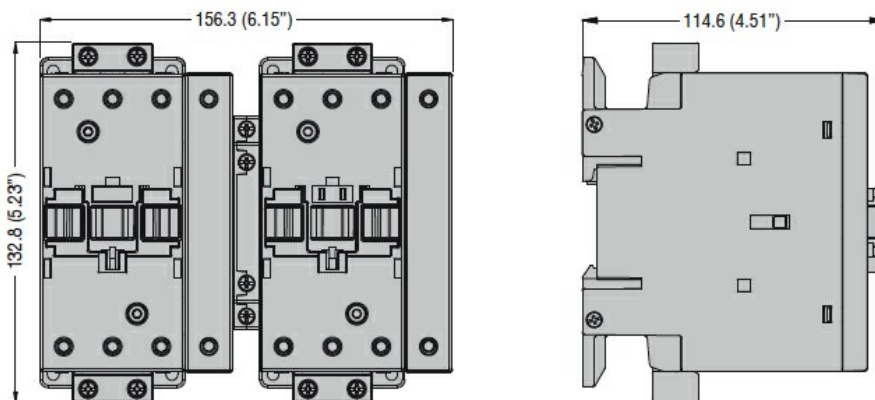

Wiring diagrams

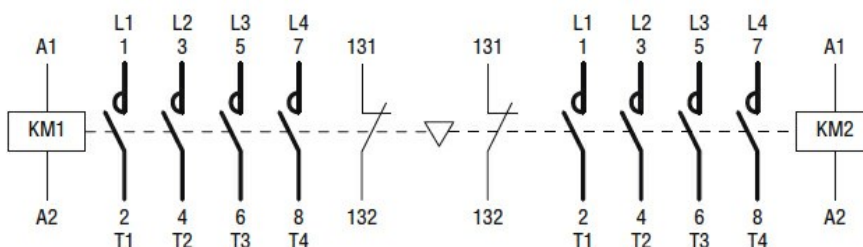

ETIM classification

ETIM 8.0

EC000010 -
Combination of
contactors