

# 1SNA115168R2300 ✓ ACTIVE

TE Internal #: 1SNA115168R2300

TE Internal Description: M4/6.DD

[View on TE.com >](#)

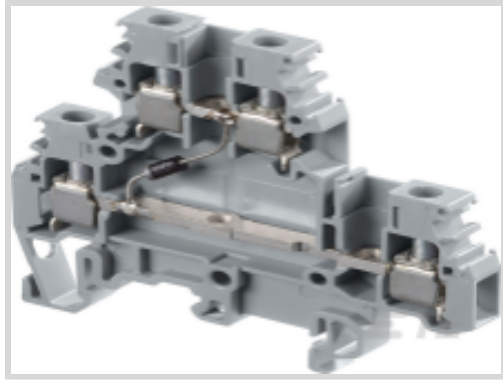

## Product Compliance

[For compliance documentation, visit the product page on TE.com>](#)

EU RoHS Directive 2011/65/EU	Compliant
EU ELV Directive 2000/53/EC	Compliant
China RoHS 2 Directive MIIT Order No 32, 2016	No Restricted Materials Above Threshold
EU REACH Regulation (EC) No. 1907/2006	Current ECHA Candidate List: JUNE 2022 (224) Candidate List Declared Against: JUNE 2022 (224) Does not contain REACH SVHC
Halogen Content	Not Yet Reviewed for halogen content
Solder Process Capability	Not reviewed for solder process capability

### Product Compliance Disclaimer

This information is provided based on reasonable inquiry of our suppliers and represents our current actual knowledge based on the information they provided. This information is subject to change. The part numbers that TE has identified as EU RoHS compliant have a maximum concentration of 0.1% by weight in homogenous materials for lead, hexavalent chromium, mercury, PBB, PBDE, DBP, BBP, DEHP, DIBP, and 0.01% for cadmium, or qualify for an exemption to these limits as defined in the Annexes of Directive 2011/65/EU (RoHS2). Finished electrical and electronic equipment products will be CE marked as required by Directive 2011/65/EU. Components may not be CE marked. Additionally, the part numbers that TE has identified as EU ELV compliant have a maximum concentration of 0.1% by weight in homogenous materials for lead, hexavalent chromium, and mercury, and 0.01% for cadmium, or qualify for an exemption to these limits as defined in the Annexes of Directive 2000/53/EC (ELV). Regarding the REACH Regulation, the information TE provides on SVHC in articles for this part number is based on the latest European Chemicals Agency (ECHA) 'Guidance on requirements for substances in articles' posted at this URL: <https://echa.europa.eu/guidance-documents/guidance-on-reach>

## Compatible Parts

TE Part # 1SNA163311R2200  
[PC61-10](#)

TE Part # 1SNA233000R0100  
[RC610](#)

TE Part # 1SNA007865R2600  
[FC2](#)

TE Part # 1SNA114205R2000  
[AD2.5](#)

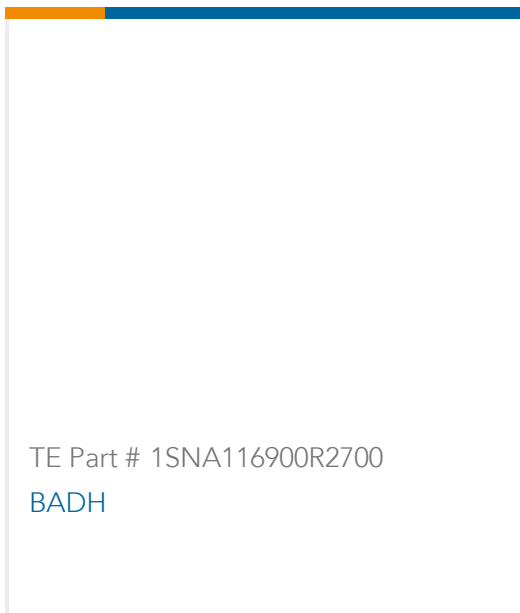

TE Part # 1SNA116900R2700  
BADH

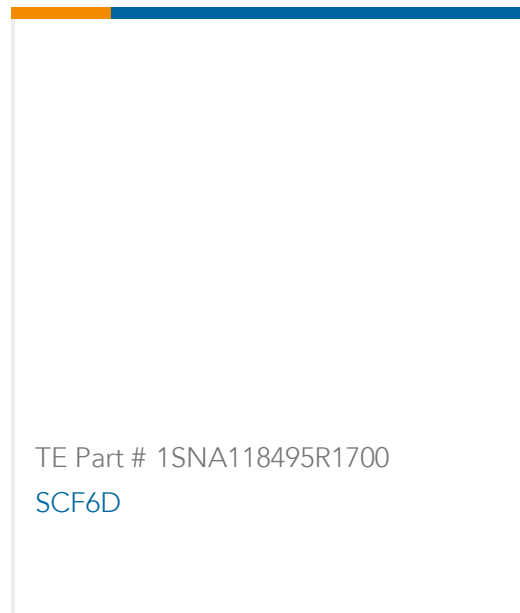

TE Part # 1SNA118495R1700  
SCF6D

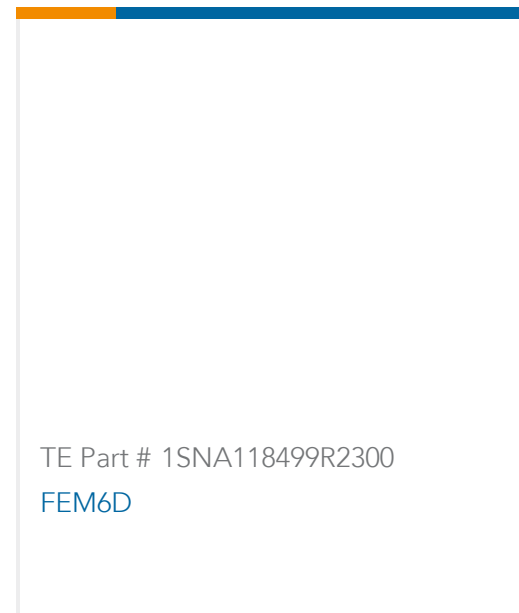

TE Part # 1SNA118499R2300  
FEM6D

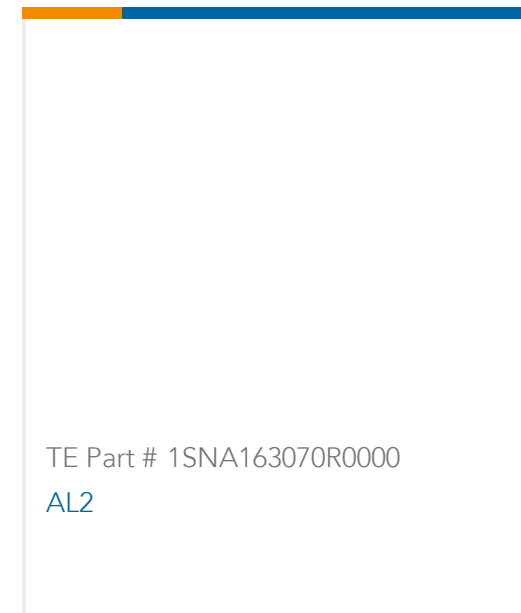

TE Part # 1SNA163070R0000  
AL2



TE Part # 1SNA163261R0000  
AL3

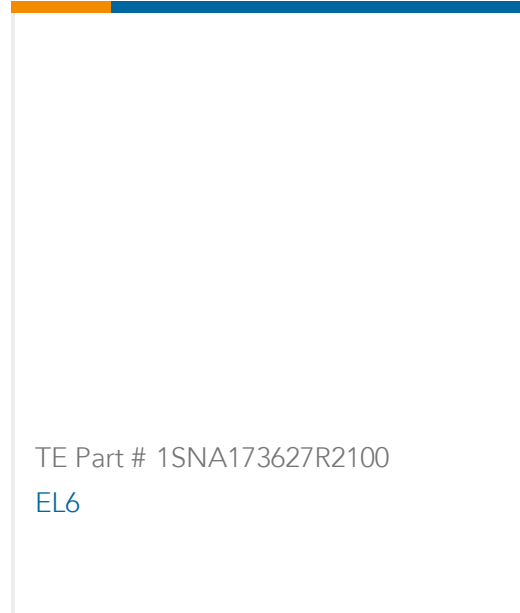

TE Part # 1SNA173627R2100  
EL6



TE Part # 1SNA179668R2000  
BJMI6D-2



TE Part # 1SNA179669R2100  
BJMI6D-3



TE Part # 1SNA179670R2600  
BJMI6D-4



TE Part # 1SNA179671R1300  
BJMI6D-5



TE Part # 1SNA179672R1400  
BJMI6D-10



TE Part # 1SNA163218R0500  
DCG



TE Part # 1SNA167225R2000  
BJP61



TE Part # 1SNA168400R1600  
EV6D



TE Part # 1SNA168485R2700  
BJS61-10

### Customers Also Bought



TE Part #1SNA115116R0700  
M4/6



TE Part #1SNA115118R1100  
M6/8



TE Part #1SNA115271R2200  
M4/6.D2



TE Part #1SNK900652R0000  
SC-JB8-2

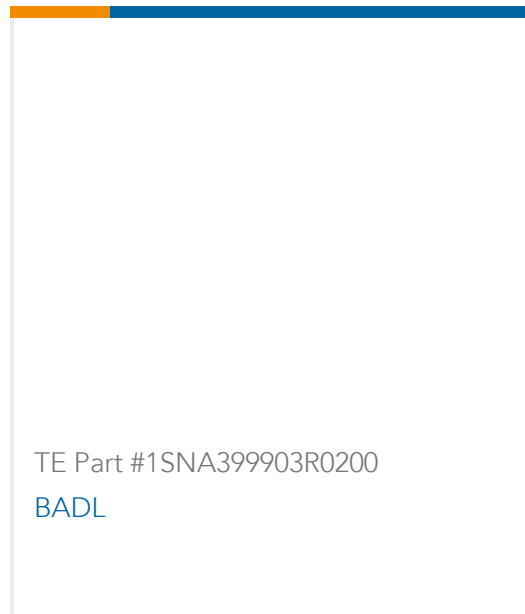
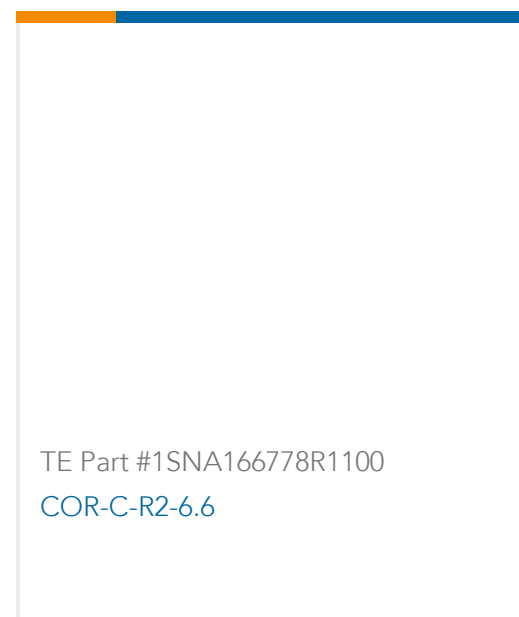
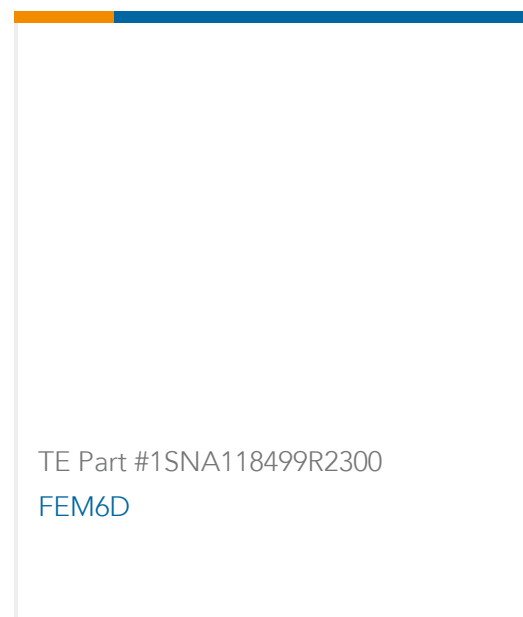
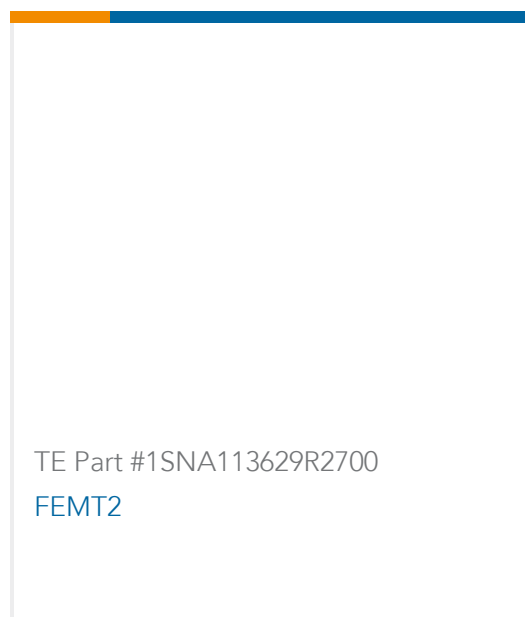

## Documents

### CAD Files

[3D PDF](#)

[3D](#)

[Customer View Model](#)

[ENG\\_CVM\\_CVM\\_1SNA115168R2300\\_A.2d\\_dxf.zip](#)

English

[Customer View Model](#)

[ENG\\_CVM\\_CVM\\_1SNA115168R2300\\_A.3d\\_igs.zip](#)

English

[Customer View Model](#)

[ENG\\_CVM\\_CVM\\_1SNA115168R2300\\_A.3d\\_stp.zip](#)

English

By downloading the CAD file I accept and agree to the [Terms and Conditions](#) of use.

### Datasheets & Catalog Pages

[M4/6.DD](#)

English

[ENTRELEC Terminal Block - Master Catalog](#)

English

[ENTRELEC Terminal Blocks Catalogue \(RUS\)](#)