

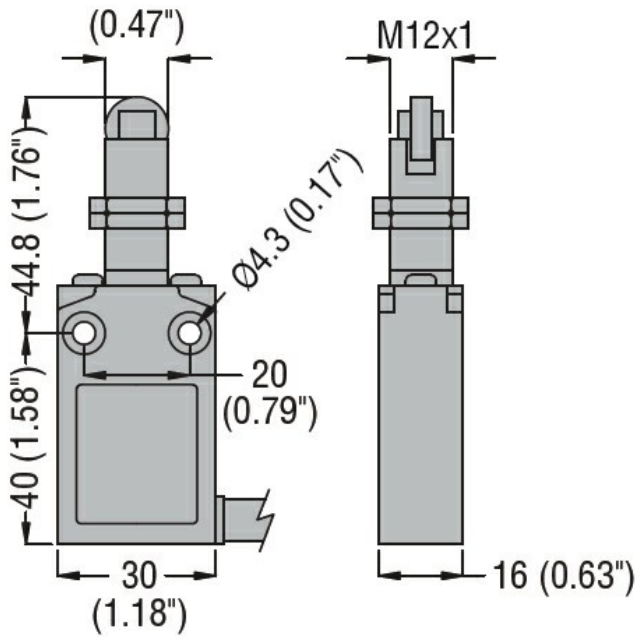

Product designation	M12 head top roller push plunger		
Product type designation	KPB6		
General characteristics			
Material	Housing	Aluminium-zinc alloy	
	Roller	Metal	
Contact characteristics			
Type of contact	1NO+1NC Slow action		
Thermal current I _{th}	A	10	
IEC/EN 60947-5-1 designation	B300 R300		
Rated insulation voltage U _i	V	400	
Rated impulse withstand voltage U _{imp}	kV	4	
Insulation class	I		
IEC Conventional free air thermal current I _{th}	A	10	
Resistance per pole (average value)	mΩ	<25	
Conductivity	10mA 5V		
Mechanical features			
Operating head fixing	Fixed		
Operating torque	N	10	
	lb	2.2	
Tightening torque (Max)			
Switch fixing	Nm	2.5	
	lbin	22.1	
Weight	g	310	
Operations			
Mechanical life	cycles	>10000000	
Mechanical operation	cycles/h	3600	
Ambient conditions			
Temperature			
Operating temperature	min	°C	-25
	max	°C	+70
Storage temperature	min	°C	-40
	max	°C	+70
Resistance & Protection			
IP degree	Body housing	IP67	
Pollution degree	3		
Dimensions			



Wiring diagrams

Slow action

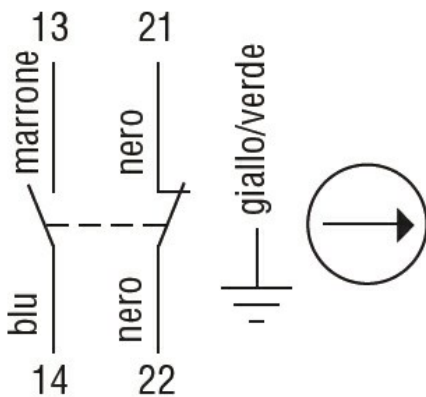

1NO + 1NC

Certifications and compliance

Compliance

CSA C22.2 n° 14.
IEC/EN 60947-1
IEC/EN 60947-5-1
UL508

Certificates

cULus
EAC

ETIM classification

ETIM 8.0

EC000030 - End switch