

320 - Cordon

Code: 998004-00

INFORMATIONS GÉNÉRALES

Article	320 - Cordon
Code	998004-00

DIMENSIONS ET POIDS

Poids (Kg)	0.044 kg
------------	----------

CARACTÉRISTIQUES ÉLECTRIQUES ET CONTRÔLES

Alimentation	S
--------------	---

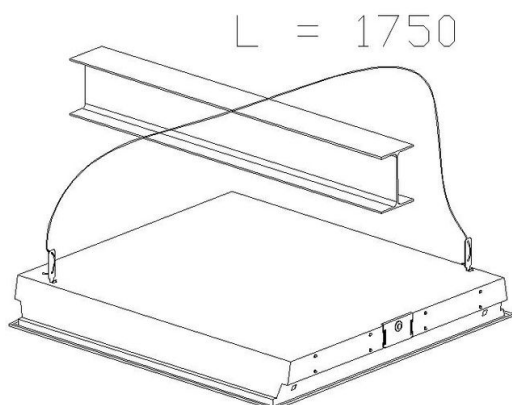

320 Cordina



320 - Cordon

Code: 998004-00



320 - Cordon

Code: 998004-00

MATÉRIAUX ET COULEURS

Corps	cordon de sécurité en acier.
Peinture	peint par cataphorèse.
Couleur	Inox

NORMES ET CONFORMITÉ

Marquages et essais	CE
---------------------	----

GARANTIE

Garantie après-vente	2 yr
----------------------	------

L = 1750

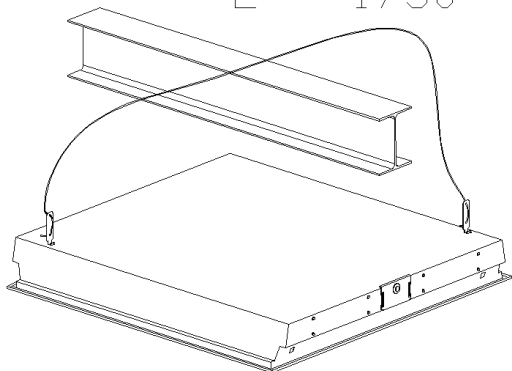

TÉLÉCHARGEMENT

MONTAGES

InstructionsMontage acc.320.pdf

DESSINS

DessinTechnique 320.dxf



320 - Cordon

Code: 998004-00



840 LED Panel - UGR<19 - CRI>90



840 LED Panel R - UGR<19 - CRI>90



844 LED Panel HE - UGR<19 - DIP SWITCH

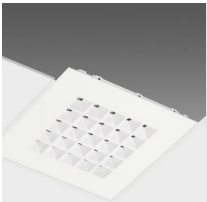

810 Comfortsquare - 76° - DIP SWITCH

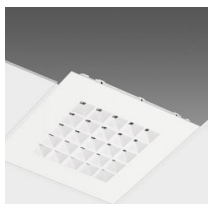

811 Comfortsquare - 43° - DIP SWITCH



841 Minicomfort LED R - UGR<16



841 Minicomfort LED x2 - UGR<16



841 Minicomfort LED x3 - UGR<16

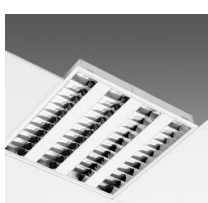

841 Minicomfort LED x4 - UGR<16



861 Comfortlight UGR<19



864 Comfortlight - UGR<16



833 Creta - UGR<17



831 Rodi IP65 - UGR<22



831 Rodi R IP65 - UGR<22

320 - Cordon

Code: 998004-00



842 LED Panel - UGR<19 - CRI≥80



842 LED Panel R - UGR<19 - CRI≥80



845 Comfort Panel - IP65-IP20 - pour environnements aseptiques



813 Comfortsquare HCL - WIRELESS - cellule de présence-luminosité

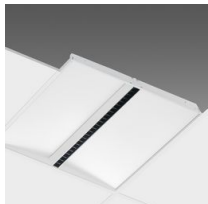

916 Ibis - UGR<16

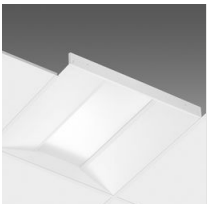

854 Heron - UGR<19

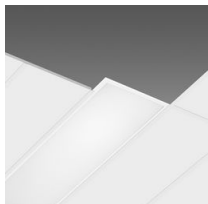

830 Rodi R UGR<19



830 Rodi UGR<19

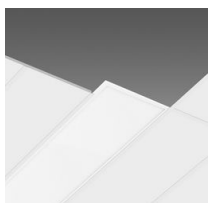

832 Rodi R UGR<22



832 Rodi UGR<22



847 Comfort Panel - IP65 - pour environnements aseptiques