



# IMF18-12NPSNC0S

IMF

INDUCTIVE PROXIMITY SENSORS

**SICK**  
Sensor Intelligence.



### Ordering information

| Type            | Part no. |
|-----------------|----------|
| IMF18-12NPSNCOS | 1076666  |

**Included in delivery:** BEF-MU-M18N1 (1)

Other models and accessories → [www.sick.com/IMF](http://www.sick.com/IMF)

Illustration may differ



### Detailed technical data

#### Features

|  |   |
|--|---|
| <b>Housing</b>                             | Cylindrical thread design                 |
| <b>Housing</b>                             | Standard design                           |
| <b>Thread size</b>                         | M18 x 1                                   |
| <b>Diameter</b>                            | Ø 18 mm                                   |
| <b>Sensing range <math>S_n</math></b>      | 12 mm                                     |
| <b>Safe sensing range <math>S_a</math></b> | 9.72 mm                                   |
| <b>Installation type</b>                   | Non-flush                                 |
| <b>Switching frequency</b>                 | 1,000 Hz                                  |
| <b>Connection type</b>                     | Male connector M12, 4-pin <sup>1)</sup>   |
| <b>Switching output</b>                    | PNP                                       |
| <b>Output function</b>                     | NO  |
| <b>Electrical wiring</b>                   | DC 3-wire                                 |
| <b>Enclosure rating</b>                    | IP68 <sup>2)</sup><br>IP69K <sup>3)</sup> |
| <b>Special features</b>                    | Resistant to cleaning agents              |
| <b>Special applications</b>                | Hygienic and washdown zones               |
| <b>Items supplied</b>                      | Mounting nut, V4A stainless steel (2x)    |

<sup>1)</sup> With gold plated contact pins.

<sup>2)</sup> According to EN 60529.

<sup>3)</sup> According to ISO 20653:2013-03.

## Mechanics/electronics

|   |  |
|---|--|
| <b>Supply voltage</b>                       | 10 V DC ... 30 V DC  |
| <b>Ripple</b>                               | ≤ 10 %   |
| <b>Voltage drop</b>                         | ≤ 2 V <sup>1)</sup>  |
| <b>Hysteresis</b>                           | 3 % ... 20 %   |
| <b>Reproducibility</b>                      | ≤ 2 % <sup>2) 3)</sup>   |
| <b>Temperature drift (of S<sub>r</sub>)</b> | ± 10 %   |
| <b>EMC</b>                                  | According to EN 60947-5-2  |
| <b>Continuous current I<sub>a</sub></b>     | ≤ 200 mA   |
| <b>No load current</b>                      | ≤ 10 mA  |
| <b>Short-circuit protection</b>             | ✓  |
| <b>Reverse polarity protection</b>          | ✓  |
| <b>Power-up pulse protection</b>            | ✓  |
| <b>Shock and vibration resistance</b>       | 100 g / 2 ms / 500 cycles; 150 g / 1 Mio cycles; 10 Hz ... 55 Hz / 1 mm; 55 Hz ... 500 Hz / 60 g |
| <b>Ambient operating temperature</b>        | -40 °C ... +100 °C   |
| <b>Housing material</b>                     | Stainless steel V4A, DIN 1.4404 / AISI 316L  |
| <b>Sensing face material</b>                | Plastic, LCP   |
| <b>Housing length</b>                       | 65 mm  |
| <b>Thread length</b>                        | 39 mm  |
| <b>Tightening torque, max.</b>              | Typ. 90 Nm   |
| <b>Protection class</b>                     | III  |
| <b>UL File No.</b>                          | E181493  |

<sup>1)</sup> At I<sub>a</sub> max.

<sup>2)</sup> Supply voltage U<sub>B</sub> and constant ambient temperature T<sub>a</sub>.

<sup>3)</sup> Of S<sub>r</sub>.

## Safety-related parameters

|                                     |             |
|-------------------------------------|-------------|
| <b>MTTF<sub>D</sub></b>             | 1,971 years |
| <b>DC<sub>avg</sub></b>             | 0 %         |
| <b>T<sub>M</sub> (mission time)</b> | 20 years    |

## Communication interface

|                                       |                                |
|---------------------------------------|--------------------------------|
| <b>Communication interface</b>        | IO-Link V1.0                   |
| <b>Communication Interface detail</b> | COM2 (38,4 kBaud)              |
| <b>Process data length</b>            | 1 Byte                         |
| <b>Process data structure</b>         | Bit 0 = S <sub>r</sub> reached |

## Reduction factors

|                                   |  |
|-----------------------------------|--|
| <b>Note</b>                       | The values are reference values which may vary |
| <b>Stainless steel (V2A, 304)</b> | Approx. 0.7                                    |
| <b>Aluminum (Al)</b>              | Approx. 0.43                                   |
| <b>Copper (Cu)</b>                | Approx. 0.37                                   |
| <b>Brass (Br)</b>                 | Approx. 0.43                                   |

Installation note

| Remark   | Associated graphic see "Installation" |
|----------|---------------------------------------|
| <b>A</b> | 18 mm                                 |
| <b>B</b> | 45 mm                                 |
| <b>C</b> | 18 mm                                 |
| <b>D</b> | 36 mm                                 |
| <b>E</b> | 12 mm                                 |
| <b>F</b> | 96 mm                                 |

Classifications

|                       |          |
|-----------------------|----------|
| <b>ECLASS 5.0</b>     | 27270101 |
| <b>ECLASS 5.1.4</b>   | 27270101 |
| <b>ECLASS 6.0</b>     | 27270101 |
| <b>ECLASS 6.2</b>     | 27270101 |
| <b>ECLASS 7.0</b>     | 27270101 |
| <b>ECLASS 8.0</b>     | 27270101 |
| <b>ECLASS 8.1</b>     | 27270101 |
| <b>ECLASS 9.0</b>     | 27270101 |
| <b>ECLASS 10.0</b>    | 27270101 |
| <b>ECLASS 11.0</b>    | 27270101 |
| <b>ECLASS 12.0</b>    | 27274001 |
| <b>ETIM 5.0</b>       | EC002714 |
| <b>ETIM 6.0</b>       | EC002714 |
| <b>ETIM 7.0</b>       | EC002714 |
| <b>ETIM 8.0</b>       | EC002714 |
| <b>UNSPSC 16.0901</b> | 39122230 |

Adjustments

Installation aid

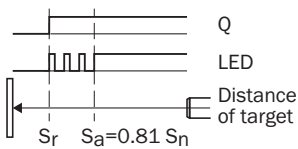

### Installation note

Non-flush installation

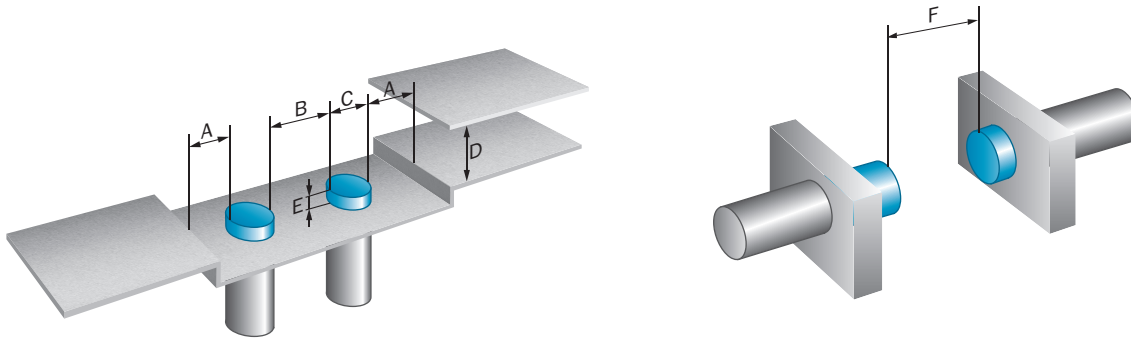

### Connection diagram

Cd-456

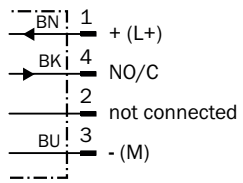

### Response diagram

Response diagram

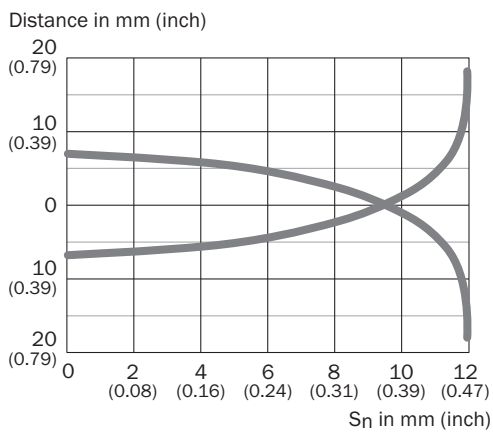



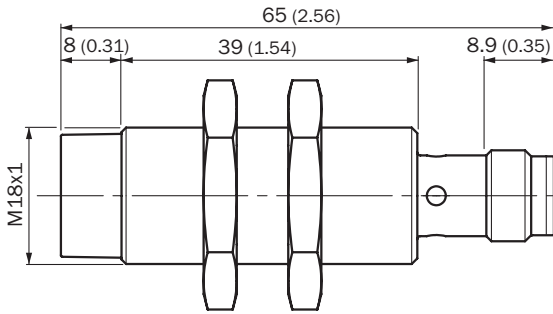

**Dimensional drawing** (Dimensions in mm (inch))





IMF18, non flush





**Recommended accessories**

Other models and accessories → [www.sick.com/IMF](http://www.sick.com/IMF)

|   | Brief description   | Type            | Part no. |
|---|---|-----------------|----------|
| <b>Universal bar clamp systems</b>  |   |                 |          |
|    | Plate NO6N for universal clamp bracket, M18, Stainless steel 1.4571 (sheet), Stainless steel 1.4408 (clamp), Universal clamp (5322627), mounting hardware   | BEF-KHS-N06N    | 2051622  |
| <b>Mounting brackets and plates</b>   |   |                 |          |
|  | Mounting plate for M18 sensors, stainless steel, without mounting hardware  | BEF-WG-M18N     | 5320948  |
|  | Mounting bracket for M18 sensors, stainless steel, without mounting hardware  | BEF-WN-M18N     | 5320947  |
| <b>Others</b>   |   |                 |          |
|  | <ul style="list-style-type: none"> <li>• <b>Connection type head A:</b> Female connector, M12, 4-pin, straight</li> <li>• <b>Connection type head B:</b> Flying leads</li> <li>• <b>Signal type:</b> Sensor/actuator cable</li> <li>• <b>Cable:</b> 2 m, 4-wire, PP</li> <li>• <b>Description:</b> Sensor/actuator cable, unshielded</li> <li>• <b>Connection systems:</b> Flying leads</li> <li>• <b>Note:</b> This product is generally resistant to chemical cleaning agents (see ECOLAB) and other chemical compounds such as H2O2 and CH2O2. Before permanent installation is carried out, the material's resistance to the cleaning agent being used must be checked., Resistant against lactic acid &amp; hydrogen peroxide (H2O2)</li> <li>• <b>Application:</b> Hygienic and washdown zones, Drag chain operation</li> </ul> | DOL-1204-G02MRN | 6058291  |
|  | <ul style="list-style-type: none"> <li>• <b>Connection type head A:</b> Female connector, M12, 4-pin, straight</li> <li>• <b>Connection type head B:</b> Flying leads</li> <li>• <b>Signal type:</b> Sensor/actuator cable</li> <li>• <b>Cable:</b> 5 m, 4-wire, PP</li> <li>• <b>Description:</b> Sensor/actuator cable, unshielded</li> <li>• <b>Connection systems:</b> Flying leads</li> <li>• <b>Note:</b> This product is generally resistant to chemical cleaning agents (see ECOLAB) and other chemical compounds such as H2O2 and CH2O2. Before permanent installation is carried out, the material's resistance to the cleaning agent being used must be checked., Resistant against lactic acid &amp; hydrogen peroxide (H2O2)</li> <li>• <b>Application:</b> Hygienic and washdown zones, Drag chain operation</li> </ul> | DOL-1204-G05MRN | 6058476  |

|   | Brief description  | Type            | Part no. |
|---|--|-----------------|----------|
|    | <ul style="list-style-type: none"> <li>• <b>Connection type head A:</b> Female connector, M12, 4-pin, angled</li> <li>• <b>Connection type head B:</b> Flying leads</li> <li>• <b>Signal type:</b> Sensor/actuator cable</li> <li>• <b>Cable:</b> 2 m, 4-wire, PP</li> <li>• <b>Description:</b> Sensor/actuator cable, unshielded</li> <li>• <b>Connection systems:</b> Flying leads</li> <li>• <b>Note:</b> This product is generally resistant to chemical cleaning agents (see ECOLAB) and other chemical compounds such as H2O2 and CH2O2. Before permanent installation is carried out, the material's resistance to the cleaning agent being used must be checked., Resistant against lactic acid &amp; hydrogen peroxide (H2O2)</li> <li>• <b>Application:</b> Hygienic and washdown zones, Drag chain operation</li> </ul>  | DOL-1204-W02MRN | 6058474  |
|    | <ul style="list-style-type: none"> <li>• <b>Connection type head A:</b> Female connector, M12, 4-pin, angled</li> <li>• <b>Connection type head B:</b> Flying leads</li> <li>• <b>Signal type:</b> Sensor/actuator cable</li> <li>• <b>Cable:</b> 5 m, 4-wire, PP</li> <li>• <b>Description:</b> Sensor/actuator cable, unshielded</li> <li>• <b>Connection systems:</b> Flying leads</li> <li>• <b>Note:</b> This product is generally resistant to chemical cleaning agents (see ECOLAB) and other chemical compounds such as H2O2 and CH2O2. Before permanent installation is carried out, the material's resistance to the cleaning agent being used must be checked., Resistant against lactic acid &amp; hydrogen peroxide (H2O2)</li> <li>• <b>Application:</b> Hygienic and washdown zones, Drag chain operation</li> </ul>  | DOL-1204-W05MRN | 6058477  |
|    | <ul style="list-style-type: none"> <li>• <b>Connection type head A:</b> Female connector, M12, 4-pin, angled</li> <li>• <b>Connection type head B:</b> Flying leads</li> <li>• <b>Signal type:</b> Sensor/actuator cable</li> <li>• <b>Cable:</b> 2 m, 4-wire, PP</li> <li>• <b>Description:</b> Sensor/actuator cable, unshielded, LED function display</li> <li>• <b>Connection systems:</b> Flying leads</li> <li>• <b>Note:</b> This product is generally resistant to chemical cleaning agents (see ECOLAB) and other chemical compounds such as H2O2 and CH2O2. Before permanent installation is carried out, the material's resistance to the cleaning agent being used must be checked., Resistant against lactic acid &amp; hydrogen peroxide (H2O2), only suitable for PNP sensors</li> <li>• <b>Application:</b> Hygienic and washdown zones, Drag chain operation</li> </ul> | DOL-1204-L02MRN | 6058482  |
|  | <ul style="list-style-type: none"> <li>• <b>Connection type head A:</b> Female connector, M12, 4-pin, angled</li> <li>• <b>Connection type head B:</b> Flying leads</li> <li>• <b>Signal type:</b> Sensor/actuator cable</li> <li>• <b>Cable:</b> 5 m, 4-wire, PP</li> <li>• <b>Description:</b> Sensor/actuator cable, unshielded, LED function display</li> <li>• <b>Connection systems:</b> Flying leads</li> <li>• <b>Note:</b> This product is generally resistant to chemical cleaning agents (see ECOLAB) and other chemical compounds such as H2O2 and CH2O2. Before permanent installation is carried out, the material's resistance to the cleaning agent being used must be checked., Resistant against lactic acid &amp; hydrogen peroxide (H2O2), only suitable for PNP sensors</li> <li>• <b>Application:</b> Hygienic and washdown zones, Drag chain operation</li> </ul> | DOL-1204-L05MRN | 6058483  |
|  | <ul style="list-style-type: none"> <li>• <b>Connection type head A:</b> Female connector, M12, 4-pin, straight</li> <li>• <b>Connection type head B:</b> Male connector, M12, 4-pin, straight</li> <li>• <b>Signal type:</b> Sensor/actuator cable</li> <li>• <b>Cable:</b> 2 m, 4-wire, PP</li> <li>• <b>Description:</b> Sensor/actuator cable, unshielded</li> <li>• <b>Note:</b> This product is generally resistant to chemical cleaning agents (see ECOLAB) and other chemical compounds such as H2O2 and CH2O2. Before permanent installation is carried out, the material's resistance to the cleaning agent being used must be checked., Resistant against lactic acid &amp; hydrogen peroxide (H2O2)</li> <li>• <b>Application:</b> Hygienic and washdown zones, Drag chain operation</li> </ul>   | DSL-1204-G02MRN | 6058499  |

|   | Brief description  | Type            | Part no. |
|---|--|-----------------|----------|
|  | <ul style="list-style-type: none"> <li>• <b>Connection type head A:</b> Female connector, M12, 4-pin, straight</li> <li>• <b>Connection type head B:</b> Male connector, M12, 4-pin, straight</li> <li>• <b>Signal type:</b> Sensor/actuator cable</li> <li>• <b>Cable:</b> 5 m, 4-wire, PP</li> <li>• <b>Description:</b> Sensor/actuator cable, unshielded</li> <li>• <b>Note:</b> This product is generally resistant to chemical cleaning agents (see ECOLAB) and other chemical compounds such as H2O2 and CH2O2. Before permanent installation is carried out, the material's resistance to the cleaning agent being used must be checked., Resistant against lactic acid &amp; hydrogen peroxide (H2O2)</li> <li>• <b>Application:</b> Hygienic and washdown zones, Drag chain operation</li> </ul> | DSL-1204-G05MRN | 6058500  |
|  | <ul style="list-style-type: none"> <li>• <b>Connection type head A:</b> Female connector, M12, 4-pin, angled</li> <li>• <b>Connection type head B:</b> Male connector, M12, 4-pin, straight</li> <li>• <b>Signal type:</b> Sensor/actuator cable</li> <li>• <b>Cable:</b> 2 m, 4-wire, PP</li> <li>• <b>Description:</b> Sensor/actuator cable, unshielded</li> <li>• <b>Note:</b> This product is generally resistant to chemical cleaning agents (see ECOLAB) and other chemical compounds such as H2O2 and CH2O2. Before permanent installation is carried out, the material's resistance to the cleaning agent being used must be checked., Resistant against lactic acid &amp; hydrogen peroxide (H2O2)</li> <li>• <b>Application:</b> Hygienic and washdown zones, Drag chain operation</li> </ul>   | DSL-1204-B02MRN | 6058502  |
|  | <ul style="list-style-type: none"> <li>• <b>Connection type head A:</b> Female connector, M12, 4-pin, angled</li> <li>• <b>Connection type head B:</b> Male connector, M12, 4-pin, straight</li> <li>• <b>Signal type:</b> Sensor/actuator cable</li> <li>• <b>Cable:</b> 5 m, 4-wire, PP</li> <li>• <b>Description:</b> Sensor/actuator cable, unshielded</li> <li>• <b>Note:</b> This product is generally resistant to chemical cleaning agents (see ECOLAB) and other chemical compounds such as H2O2 and CH2O2. Before permanent installation is carried out, the material's resistance to the cleaning agent being used must be checked., Resistant against lactic acid &amp; hydrogen peroxide (H2O2)</li> <li>• <b>Application:</b> Hygienic and washdown zones, Drag chain operation</li> </ul>   | DSL-1204-B05MRN | 6058503  |

**Recommended services**

Additional services → [www.sick.com/IMF](http://www.sick.com/IMF)

|  | Type                   | Part no.   |
|--|------------------------|------------|
| <p>Function Block Factory</p> <ul style="list-style-type: none"> <li>• <b>Description:</b> The Function Block Factory supports common programmable logic controllers (PLCs) from various manufacturers, such as Siemens, Beckhoff, Rockwell Automation and B&amp;R. More information on the FBF can be found &lt;a href="https://fbf.cloud.sick.com target="_blank"&gt; here&lt;/a&gt;.</li> <li>• <b>Note:</b> You can configure your function block at &lt;a href="https://fbf.cloud.sick.com target="_blank"&gt; Function Block Factory.&lt;/a&gt; As a login please use your SICK ID.</li> </ul> | Function Block Factory | On request |



## SICK AT A GLANCE

SICK is one of the leading manufacturers of intelligent sensors and sensor solutions for industrial applications. A unique range of products and services creates the perfect basis for controlling processes securely and efficiently, protecting individuals from accidents and preventing damage to the environment.

We have extensive experience in a wide range of industries and understand their processes and requirements. With intelligent sensors, we can deliver exactly what our customers need. In application centers in Europe, Asia and North America, system solutions are tested and optimized in accordance with customer specifications. All this makes us a reliable supplier and development partner.

Comprehensive services complete our offering: SICK LifeTime Services provide support throughout the machine life cycle and ensure safety and productivity.

For us, that is “Sensor Intelligence.”

## WORLDWIDE PRESENCE:

Contacts and other locations –[www.sick.com](http://www.sick.com)