



YF2A85-050UB6M2A85

Sensor/actuator cable

PLUG CONNECTORS AND CABLES

SICK
Sensor Intelligence.

YF2A85-050UB6M2A85 | Sensor/actuator cable

PLUG CONNECTORS AND CABLES



Ordering information

Type	Part no.
YF2A85-050UB6M2A85	2096119

Other models and accessories → www.sick.com/Sensor_actuator_cable



Detailed technical data

Technical specifications

Connection type head A	Female connector, M12, 5-pin, straight, A-coded
Connection type head B	Male connector, M12, 5-pin, straight, A-coded
Locking plug connector	Quick screw connection
Connector material	TPU
Connector color	Black
Locking nut material	Zinc die-cast, nickel-plated
Tightening torque	0.4 Nm
Cable	5 m, 5-wire, PUR, halogen-free
Jacket material	PUR, halogen-free
Jacket color	Black
Cable diameter	5.3 mm
Conductor cross section	0.34 mm ²
Shielding	Shielded
Bending radius	
	Flexible use > 10 x cable diameter
	Stationary position > 5 x cable diameter
Bending cycles	≥ 4,000,000
Reference voltage	≤ 60 V AC/DC
Current loading	4 A
Traversing speed	3 m/s
Travelling distance	10 m
Acceleration	≤ 10 m/s ²
Signal type	Sensor/actuator cable
Application	Zones with oils and lubricants Drag chain operation
Authorizations	UL
UL File No.	CYJV.E335179
Enclosure rating	IP65/ IP67/ IP68
Operating temperature	

Flexible use	-25 °C ... +80 °C
Stationary position	-40 °C ... +80 °C
Head	-25 °C ... +90 °C
Contamination rating	3
Insulation resistance	100 MΩ
Overtoltage category	III
Thermal resistance, piping	Flame retardant according to UL 1581 VW1 / CSA FT1 / IEC 60332-1, IEC 60332-2-2

Classifications

ECLASS 5.0	19030312
ECLASS 5.1.4	19030312
ECLASS 6.0	27060304
ECLASS 6.2	27060304
ECLASS 7.0	27060304
ECLASS 8.0	27060304
ECLASS 8.1	27060304
ECLASS 9.0	27060304
ECLASS 10.0	27060304
ECLASS 11.0	27060304
ECLASS 12.0	27060304
ETIM 5.0	EC000830
ETIM 6.0	EC000830
ETIM 7.0	EC003249
ETIM 8.0	EC003249
UNSPSC 16.0901	26121604

Dimensional drawing (Dimensions in mm (inch))

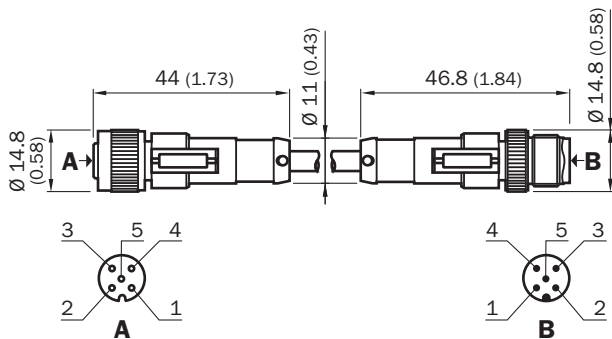

- ① brn
- ② wht
- ③ blu
- ④ blk
- ⑤ gra

SICK AT A GLANCE

SICK is one of the leading manufacturers of intelligent sensors and sensor solutions for industrial applications. A unique range of products and services creates the perfect basis for controlling processes securely and efficiently, protecting individuals from accidents and preventing damage to the environment.

We have extensive experience in a wide range of industries and understand their processes and requirements. With intelligent sensors, we can deliver exactly what our customers need. In application centers in Europe, Asia and North America, system solutions are tested and optimized in accordance with customer specifications. All this makes us a reliable supplier and development partner.

Comprehensive services complete our offering: SICK LifeTime Services provide support throughout the machine life cycle and ensure safety and productivity.

For us, that is “Sensor Intelligence.”

WORLDWIDE PRESENCE:

Contacts and other locations –www.sick.com