



GSE6-E2421V

G6

MINIATURE PHOTOELECTRIC SENSORS

SICK
Sensor Intelligence.



Ordering information

Type	Part no.
GSE6-E2421V	1084114

Other models and accessories → www.sick.com/G6

Illustration may differ



Detailed technical data

Features

Functional principle	Through-beam photoelectric sensor
Sensing range max.	0 m ... 14.5 m
Sensing range	0 m ... 10 m
Polarisation filters	No
Emitted beam	
Light source	LED ¹⁾
Type of light	Infrared light
Light spot size (distance)	Ø 460 mm (10 m)
Key LED figures	
Wave length	850 nm
Adjustment	Potentiometer, 270°
Special applications	Hygienic and washdown zones

¹⁾ Average service life: 100,000 h at T_U = +25 °C.

Electrical data

Supply voltage U_B	10 V DC ... 30 V DC ¹⁾
Ripple	± 10 % ²⁾
Current consumption	30 mA ³⁾
Protection class	III

¹⁾ Limit values when operated in short-circuit protected network: max. 8 A.

²⁾ May not exceed or fall below U_V tolerances.

³⁾ Without load.

⁴⁾ At U_V > 24 V, I_A max. = 50 mA.

⁵⁾ Signal transit time with resistive load.

⁶⁾ With light/dark ratio 1:1.

⁷⁾ A = V_S connections reverse-polarity protected.

⁸⁾ B = inputs and output reverse-polarity protected.

⁹⁾ D = outputs overcurrent and short-circuit protected.

Digital output	Type	NPN
	Switching mode	Light/dark switching
	Signal voltage NPN HIGH/LOW	Approx. $V_S / \leq 3 \text{ V}$
	Output current I_{max}	$\leq 100 \text{ mA}$ ⁴⁾
	Response time	$< 625 \mu\text{s}$ ⁵⁾
	Switching frequency	1,000 Hz ⁶⁾
Output function	Complementary switching output	
Circuit protection	A ⁷⁾ B ⁸⁾ D ⁹⁾	

- 1) Limit values when operated in short-circuit protected network: max. 8 A.
 2) May not exceed or fall below U_V tolerances.
 3) Without load.
 4) At $U_V > 24 \text{ V}$, $I_A \text{ max.} = 50 \text{ mA}$.
 5) Signal transit time with resistive load.
 6) With light/dark ratio 1:1.
 7) A = V_S connections reverse-polarity protected.
 8) B = inputs and output reverse-polarity protected.
 9) D = outputs overcurrent and short-circuit protected.

Mechanical data

Housing	Rectangular	
Dimensions (W x H x D)	15 mm x 44 mm x 22 mm	
Connection	Cable, 4-wire, 2 m ¹⁾	
Connection detail	Conductor size	0.14 mm ²
	Length of cable (L)	2 m ¹⁾
Material	Housing	Stainless steel, Stainless steel V4A (1.4404, 316L)
	Front screen	Plastic, PMMA
	Cable	PVC
Weight	150 g	

- 1) Do not bend below 0 °C.

Ambient data

Enclosure rating	IP67 IP69K ¹⁾
Ambient operating temperature	-25 °C ... +55 °C ²⁾
Ambient temperature, storage	-30 °C ... +75 °C
UL File No.	NRKH.E348498 & NRKH7.E348498

- 1) According to ISO 20653:2013-03.
 2) Temperature stability following adjustment +/-10 °C.

Classifications

ECLASS 5.0	27270901
-------------------	----------

ECLASS 5.1.4	27270901
ECLASS 6.0	27270901
ECLASS 6.2	27270901
ECLASS 7.0	27270901
ECLASS 8.0	27270901
ECLASS 8.1	27270901
ECLASS 9.0	27270901
ECLASS 10.0	27270901
ECLASS 11.0	27270901
ECLASS 12.0	27270901
ETIM 5.0	EC002716
ETIM 6.0	EC002716
ETIM 7.0	EC002716
ETIM 8.0	EC002716
UNSPSC 16.0901	39121528

Connection diagram

Cd-231

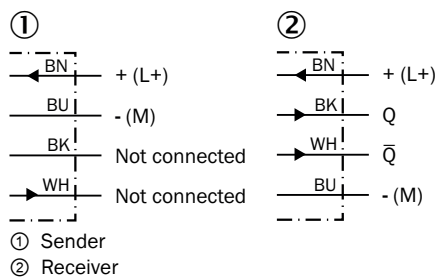

Characteristic curve

GSE6 Inox, IR, Standard

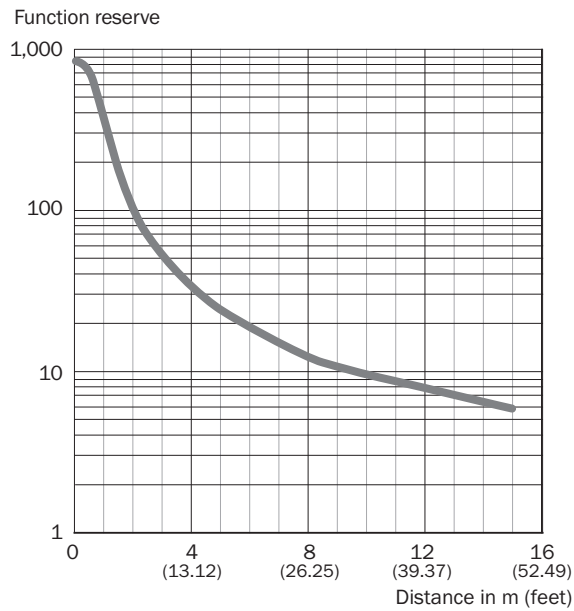

Light spot size

GSE6 Inox, IR, Standard

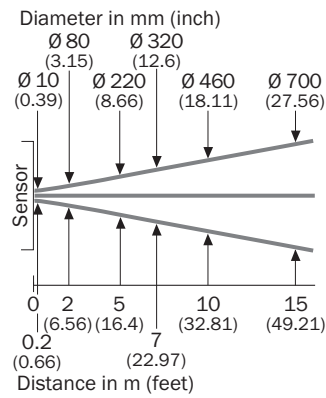

Sensing range diagram

GSE6 Inox, IR, Standard

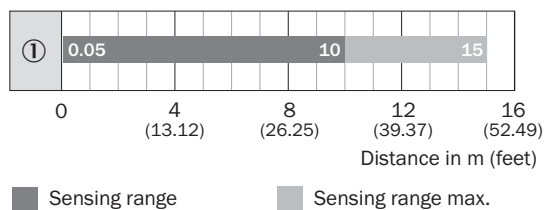

Dimensional drawing (Dimensions in mm (inch))

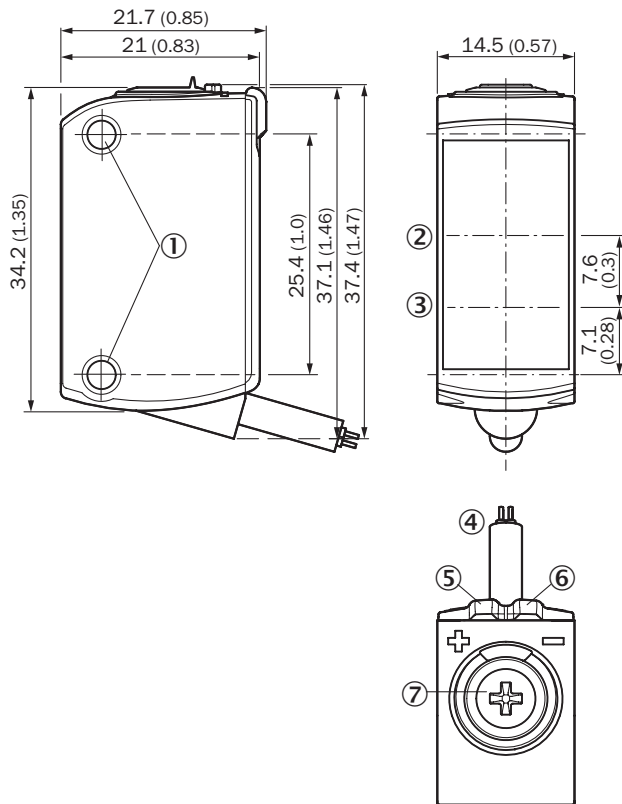

GTB6, GTE6, GL6, GSE6 Inox, cable (with male connector)



- ① M3 mounting hole
- ② Optical axis, receiver
- ③ Optical axis, sender
- ④ Connection
- ⑤ LED indicator yellow: Status of received light beam
- ⑥ LED indicator green: Supply voltage active
- ⑦ Potentiometer

Recommended accessories

Other models and accessories → www.sick.com/G6

	Brief description	Type	Part no.
Universal bar clamp systems			
	Clamp bar to fix G6 sensors on rods of 12 mm, clamp-on design up to 4 mm wall thickness, aluminum (clamp bar), stainless steel (bracket), clamp bar mounting and clamp function, mounting bracket, mounting hardware	BEF-KHS-IS12G6	2086865
Mounting brackets and plates			
	Mounting bracket for wall mounting, stainless steel, mounting hardware included	BEF-W100-A	5311520

	Brief description	Type	Part no.
Plug connectors and cables			
	<ul style="list-style-type: none">• Connection type head A: Male connector, M8, 4-pin, straight• Description: Unshielded• Connection systems: Screw-type terminals• Permitted cross-section: 0.14 mm² ... 0.5 mm²	STE-0804-G	6037323

SICK AT A GLANCE

SICK is one of the leading manufacturers of intelligent sensors and sensor solutions for industrial applications. A unique range of products and services creates the perfect basis for controlling processes securely and efficiently, protecting individuals from accidents and preventing damage to the environment.

We have extensive experience in a wide range of industries and understand their processes and requirements. With intelligent sensors, we can deliver exactly what our customers need. In application centers in Europe, Asia and North America, system solutions are tested and optimized in accordance with customer specifications. All this makes us a reliable supplier and development partner.

Comprehensive services complete our offering: SICK LifeTime Services provide support throughout the machine life cycle and ensure safety and productivity.

For us, that is “Sensor Intelligence.”

WORLDWIDE PRESENCE:

Contacts and other locations –www.sick.com