



M40E-67A105RA0

M4000 Area

SAFETY LIGHT CURTAINS

SICK
Sensor Intelligence.



Ordering information

Resolution	Scanning range	Protective field height	System part	Type	Part no.
80 mm	90 m	1,350 mm	Receiver	M40E-67A105RA0	1200605

Other models and accessories → www.sick.com/M4000_Area

Illustration may differ



Detailed technical data

Features

Resolution	80 mm
Scanning range	90 m
Low scanning range	0.5 m ... 20 m
Great scanning range	9 m ... 90 m
Protective field height	1,350 mm
Length of the monitored area	1,350 mm
Response time	17 ms
Synchronization	Optical synchronisation

Safety-related parameters

Type	Type 4 (IEC 61496-1)
Safety integrity level	SIL 3 (IEC 61508)
Category	Category 4 (EN ISO 13849)
Performance level	PL e (EN ISO 13849)
T_M (mission time)	20 years (EN ISO 13849)
Safe state in the event of a fault	At least one OSSD is in the OFF state.

Functions

	Functions	Delivery status
Restart interlock	✓	Internal
External device monitoring (EDM)	✓	Activated
Beam coding	✓	Uncoded
Configurable status output (ADO)	✓	Contamination (OWS)
Sender test	✓	Deactivated
Configurable scanning range	✓	Low scanning range
Safe SICK device communication via EFI	✓	

Interfaces

System connection	Connection type	Hirschmann male connector M26, 12-pin
Configuration method		PC with CDS (Configuration and Diagnostic Software)
Configuration connection		Female connector M8, 4-pin
Display elements		7-segment display, LEDs
Status display		LEDs

Electrical data

Protection class		III (IEC 61140)
Supply voltage V_S		24 V DC (19.2 V DC ... 28.8 V DC)
Residual ripple		$\leq 10\%$ ¹⁾
Power consumption		$\leq 0.6\text{ A}$ ²⁾
Output signal switching devices (OSSDs)	Type of output	2 PNP semiconductors, short-circuit protected, cross-circuit monitored ³⁾
	ON state, switching voltage HIGH	24 V DC ($V_S - 2.25\text{ V DC}$... V_S)
	OFF state, switching voltage LOW	$\leq 2\text{ V DC}$
	Current-carrying capacity per OSSD	$\leq 500\text{ mA}$

¹⁾ Within the limits of V_S .

²⁾ Without load.

³⁾ Applies to the voltage range between -30 V and $+30\text{ V}$.

Mechanical data

Housing cross-section		52 mm x 55.5 mm
Housing material		Aluminum alloy ALMGSI 0.5
Surface treatment		Powder coated
Front screen material		Polycarbonate, scratch-resistant coating

Ambient data

Enclosure rating		IP65 (EN 60529)
Ambient operating temperature		-30 °C ... $+55\text{ °C}$
Storage temperature		-30 °C ... $+70\text{ °C}$
Air humidity		15 % ... 95 %, Non-condensing
Vibration resistance		5 g, 10 Hz ... 55 Hz (IEC 60068-2-6)
Shock resistance		10 g, 16 ms (EN 60068-2-29)

Other information

Wave length		850 nm
--------------------	--	--------

Classifications

ECLASS 5.0		27272704
ECLASS 5.1.4		27272704
ECLASS 6.0		27272704
ECLASS 6.2		27272704
ECLASS 7.0		27272704
ECLASS 8.0		27272704

ECLASS 8.1	27272704
ECLASS 9.0	27272704
ECLASS 10.0	27272704
ECLASS 11.0	27272704
ECLASS 12.0	27272704
ETIM 5.0	EC002549
ETIM 6.0	EC002549
ETIM 7.0	EC002549
ETIM 8.0	EC002549
UNSPSC 16.0901	46171620

Dimensional drawing (Dimensions in mm (inch))

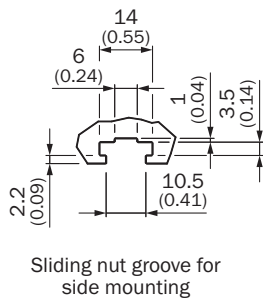
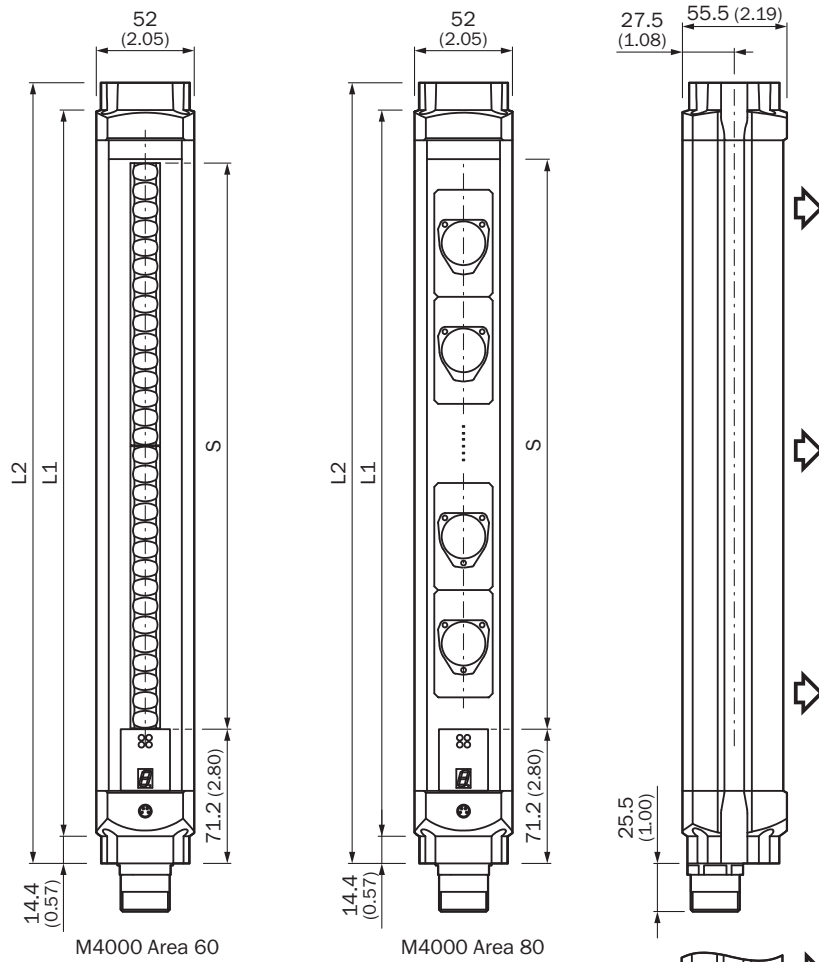

Sliding nut groove for side mounting

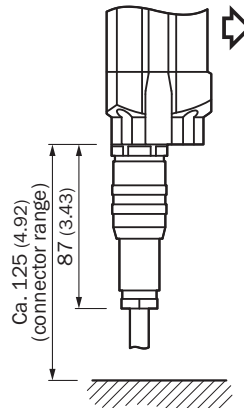









Cable socket M26 with crimp contacts (for DIN 43651)



Length of the monitored area S	L1	L2
300 (11.81)	387 (15.24)	416 (16.38)
450 (17.72)	537 (21.14)	566 (22.28)
600 (23.62)	687 (27.05)	716 (28.19)
750 (29.53)	837 (32.95)	866 (34.09)
900 (35.43)	987 (38.86)	1,016 (40.00)

Length of the monitored area S	L1	L2
1,050 (41.34)	1,137 (44.76)	1,166 (45.91)
1,200 (47.24)	1,287 (50.67)	1,316 (51.81)
1,350 (53.15)	1,437 (56.57)	1,466 (57.72)
1,500 (59.06)	1,587 (62.48)	1,616 (63.62)
1,650 (64.96)	1,737 (68.39)	1,766 (69.53)
1,800 (70.87)	1,887 (74.29)	1,916 (75.43)

Recommended accessories

Other models and accessories → www.sick.com/M4000_Area

	Brief description	Type	Part no.
Alignment aids			
	Laser alignment aid for various sensors, laser class 2 (IEC 60825). Do not look into the beam!, 19 mm x 67.3 mm x 66.9 mm	AR60	1015741
	Adapter AR60 for M4000 and M4000 Curtain	AR60 adapter, M4000	4040006
Mounting brackets and plates			
	4 pieces, Mounting kit 1, mounting bracket, rigid, L-shaped, including fixing screws and washers	BEF-3WNGBAST4	7021352
Other mounting accessories			
	2 pieces, Floor stands for the horizontal mounting of the safety light curtains C4000 Fusion, Entry/Exit, Palletizer, as well as the multi-beam safety light curtain M4000 Area, for mounting heights of between 70 mm and 780 mm., Includes mounting bracket	BEF-3HHOCAST2	2041661
Plug connectors and cables			
	<ul style="list-style-type: none"> • Connection type head A: Female connector, M26, 12-pin, straight • Description: Unshielded • Connection systems: Crimp contacts • Permitted cross-section: 0.5 mm² ... 1.5 mm² • Note: 12 crimping contacts enclosed 	DOS-0612G000GA3KM0	6020757
	<ul style="list-style-type: none"> • Connection type head A: Female connector, M26, 12-pin, angled • Description: Unshielded • Connection systems: Crimp contacts • Permitted cross-section: 0.5 mm² ... 1.5 mm² • Note: 12 crimping contacts enclosed 	DOS-0612W000GA3KM0	6020758
Terminal and alignment brackets			
	4 pieces, Mounting kit 6, side bracket, rotatable, zinc diecast	BEF-1SHABAZN4	2019506
	4 pieces, Mounting kit 12, rotatable, swivel mount	BEF-2SMGEAKU4	2030510

	Brief description	Type	Part no.
Others			
	<ul style="list-style-type: none"> • Connection type head A: Female connector, M26, 12-pin, straight • Connection type head B: Flying leads • Signal type: Sensor/actuator cable • Cable: 20 m, 12-wire, PVC • Description: Sensor/actuator cable, unshielded • Connection systems: Flying leads 	DOL-0612G20M075KM0	2022549
	<ul style="list-style-type: none"> • Connection type head A: Female connector, M26, 12-pin, straight • Connection type head B: Flying leads • Signal type: Sensor/actuator cable • Cable: 10 m, 12-wire, PVC • Description: Sensor/actuator cable, unshielded • Connection systems: Flying leads 	DOL-0612G10M075KM0	2022547
	<ul style="list-style-type: none"> • Connection type head A: Female connector, M26, 12-pin, straight • Connection type head B: Flying leads • Signal type: Sensor/actuator cable • Cable: 5 m, 12-wire, PVC • Description: Sensor/actuator cable, unshielded • Connection systems: Flying leads 	DOL-0612G05M075KM0	2022545

SICK AT A GLANCE

SICK is one of the leading manufacturers of intelligent sensors and sensor solutions for industrial applications. A unique range of products and services creates the perfect basis for controlling processes securely and efficiently, protecting individuals from accidents and preventing damage to the environment.

We have extensive experience in a wide range of industries and understand their processes and requirements. With intelligent sensors, we can deliver exactly what our customers need. In application centers in Europe, Asia and North America, system solutions are tested and optimized in accordance with customer specifications. All this makes us a reliable supplier and development partner.

Comprehensive services complete our offering: SICK LifeTime Services provide support throughout the machine life cycle and ensure safety and productivity.

For us, that is “Sensor Intelligence.”

WORLDWIDE PRESENCE:

Contacts and other locations –www.sick.com