

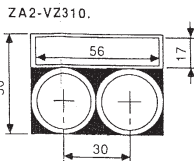

1406758015503

Assemblage et encombrements
Montage und Abmessungen

Assembly and mounting density
Istruzioni di montaggio, dimensioni d'ingombro

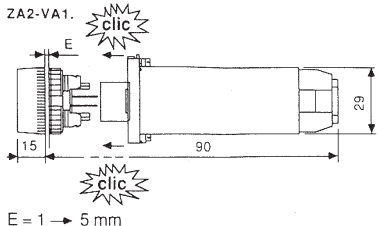

Perçage du support (Cenelec EN 50.007)
Bohrungen der Montageplatte
Panel drilling
Foratura del pannello

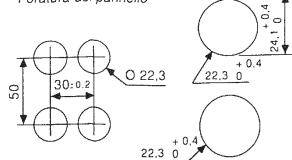

Changement d'une valeur affichée
Änderung des angezeigten Wertes
Loading a stored value
Variazione del dato visualizzato

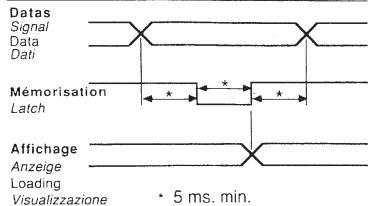

Schémas de raccordement
Anschlußpläne
Connection details
Schema dei collegamenti

ZA2-VA11(décimal + BCD)

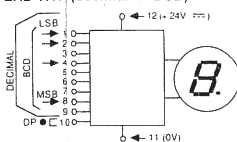

DP = Point décimal
Decimal point
Dezimal Punkt
Punto decimale

ZA2-VA12(BCD + Latch)

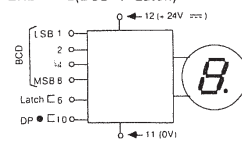

Etat 0 = -30V (0 mA) ... +5V (1.4 mA)
Etat 1 = +13V (4 mA) ... +30V (9.5 mA)

Démontage
Demontage
De-mounting
Smontaggio

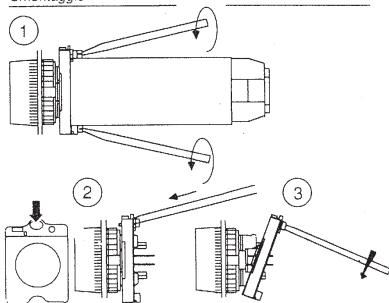

Tables d'entrées
Ansteuerung
Input tables
Tabella degli ingressi

Décimal
dezimal
Decimal
Decimale

1	2	3	4	5	6	7	8	9	Anzeige Loading Visualizzazione Affichage
0	0	0	0	0	0	0	0	0	0
1	0	0	0	0	0	0	0	0	1
0	1	0	0	0	0	0	0	0	2
0	0	1	0	0	0	0	0	0	3
0	0	0	1	0	0	0	0	0	4
0	0	0	0	1	0	0	0	0	5
0	0	0	0	0	1	0	0	0	6
0	0	0	0	0	0	1	0	0	7
0	0	0	0	0	0	0	1	0	8
0	0	0	0	0	0	0	0	1	9

BCD

8	4	2	1	Anzeige Loading Visualizzazione Affichage	8	4	2	1	Anzeige Loading Visualizzazione Affichage
0	0	0	0	0	1	0	0	1	9
0	0	0	1	1	1	0	1	0	A
0	1	0	0	2	1	0	1	1	B
0	0	1	1	3	1	1	0	0	C
0	1	0	0	4	1	1	0	1	D
0	1	0	1	5	1	1	1	0	E
0	1	1	0	6	1	1	1	1	F
0	1	1	1	7					
1	0	0	0	8					