

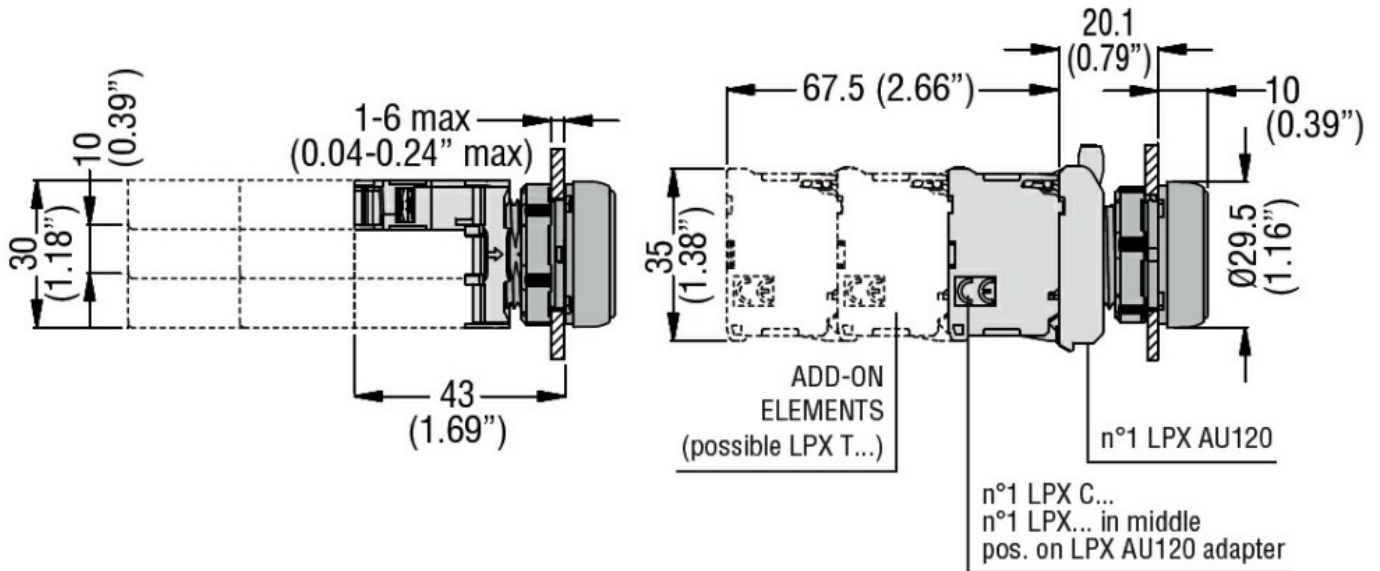

Product designation				Contact elements - without mounting adapter LPXC
Product type designation				LPXC
<b>Electrical characteristics</b>				
Rated insulation voltage $U_i$ IEC/EN	V			690
IEC Conventional free air thermal current $I_{th}$	A			10
Conductivity				1mA 5V
UL/CSA and IEC/EN 60947-5-1 designation				A600 Q600
Operating current AC15				
	12V	A	6	
	24V	A	6	
	48V	A	6	
	120V	A	6	
	240V	A	3	
	400V	A	1.9	
	480V	A	1.5	
	500V	A	1.4	
	600V	A	1.2	
Operating current DC13				
	12V	A	3	
	24V	A	3	
	48V	A	1.5	
	125V	A	0.55	
	250V	A	0.27	
	440V	A	0.15	
	500V	A	0.13	
	600V	A	0.1	
Contact resistance			mΩ	≤20
<b>Operations</b>				
Electrical life			cycles	600000
<b>Mechanical features</b>				
Operating force			kg-lb	≤0.5Kg/1.1lb
Tightening torque for terminals max			Nm	1
Terminals screw			Screw	
Conductor section	AWG/kcmil conductor section			
			max	14
	IEC			
	max	mm <sup>2</sup>	1 or 2 / 2.5	
Mounting adapter				LPXAU120
Weight			g	11
<b>Ambient conditions</b>				
Temperature	Operating temperature			
	min	°C	-25	

Storage temperature	max	°C	+70
	min	°C	-40
	max	°C	+85

**Dimensions**



**Wiring diagrams**

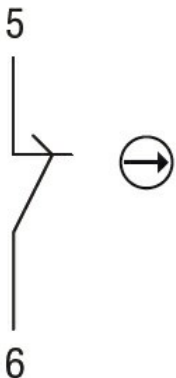

**Certifications and compliance**

**Compliance**

CSA C22.2 n° 14
IEC/EN/BS 60947-1
IEC/EN/BS 60947-5-1
UL508

**Certificates**

CCC
cULus
EAC
RINA
UL

**ETIM classification**

ETIM 8.0

EC000041 -  
Auxiliary contact  
block