

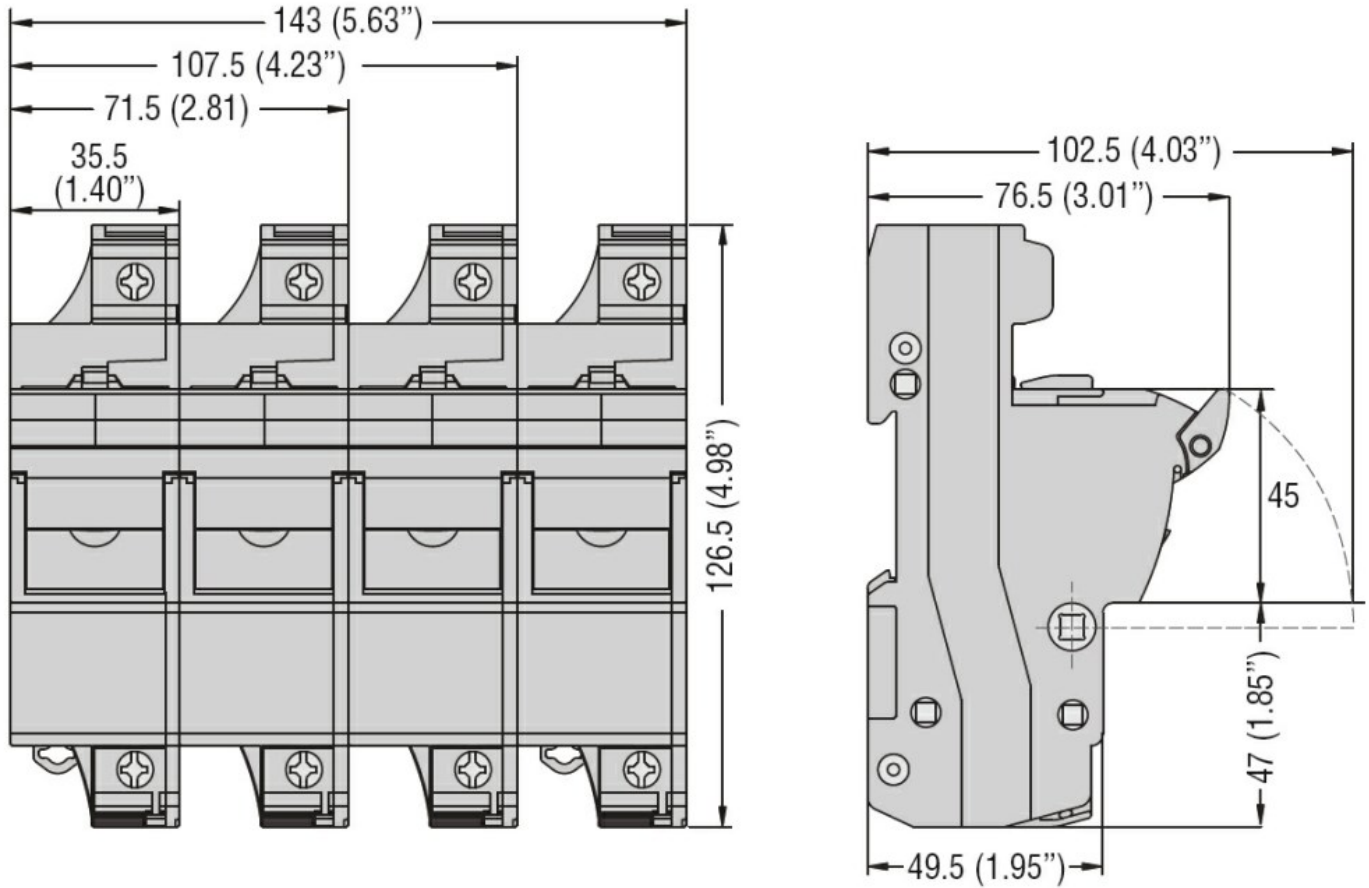

Product designation	FB		
Product type designation	Fuse holder		
Number of DIN modules	4		
Operating voltage type	AC		
Electrical features			
IEC maximum rated current (In)	A	125	
IEC maximum rated voltage (Un)	V	690	
IEC Utilization category	AC21B 690V		
Derating factor of rated current In for different ambient temperature	20°C	1	
	30°C	0.95	
	40°C	0.9	
	50°C	0.8	
	60°C	0.7	
	70°C	0.5	
	Derating factor of rated current In for side by side fuse holders (poles)	1-4	1
5-6		0.8	
7-9		0.7	
≥10		0.6	
Rated current (In)		A	100/125
Ambient conditions			
Operating temperature	min	°C	-20
	max	°C	70
Storage temperature	min	°C	-40
	max	°C	80
Max altitude	m	3000	
Mechanical features			
Operating position	normal	Vertical plan	
	allowable	Any	
Fixing	35mm DIN rail		
Tightening torque for terminals	max	Nm	4
	max	Ibin	2.9
Conductor section	Flexible max (IEC)	mm ²	35
	- Flexible max (AWG/kcmil)		2
	Rigid max (IEC)	mm ²	50
	- Rigid max (AWG/kcmil)		1
Weight	g	334	
Resistance & Protection			
Frontal IP degree	IP20		

Dimensions



Wiring diagrams

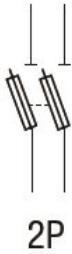

Certifications and compliance

Compliance

- CSA C22.2 n°4248.1
- IEC/EN 60269-1
- IEC/EN 60269-2
- IEC/EN 60947-1
- IEC/EN 60947-3
- UL 4248-1

Certifications

- cURus
- EAC

ETIM classification

ETIM 8.0

EC002705 -
Holder for
cylindrical fuse