

Disc 290

IK10

220-240V, 50/60Hz

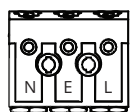
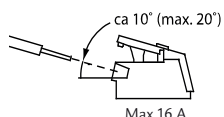
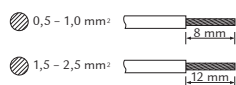
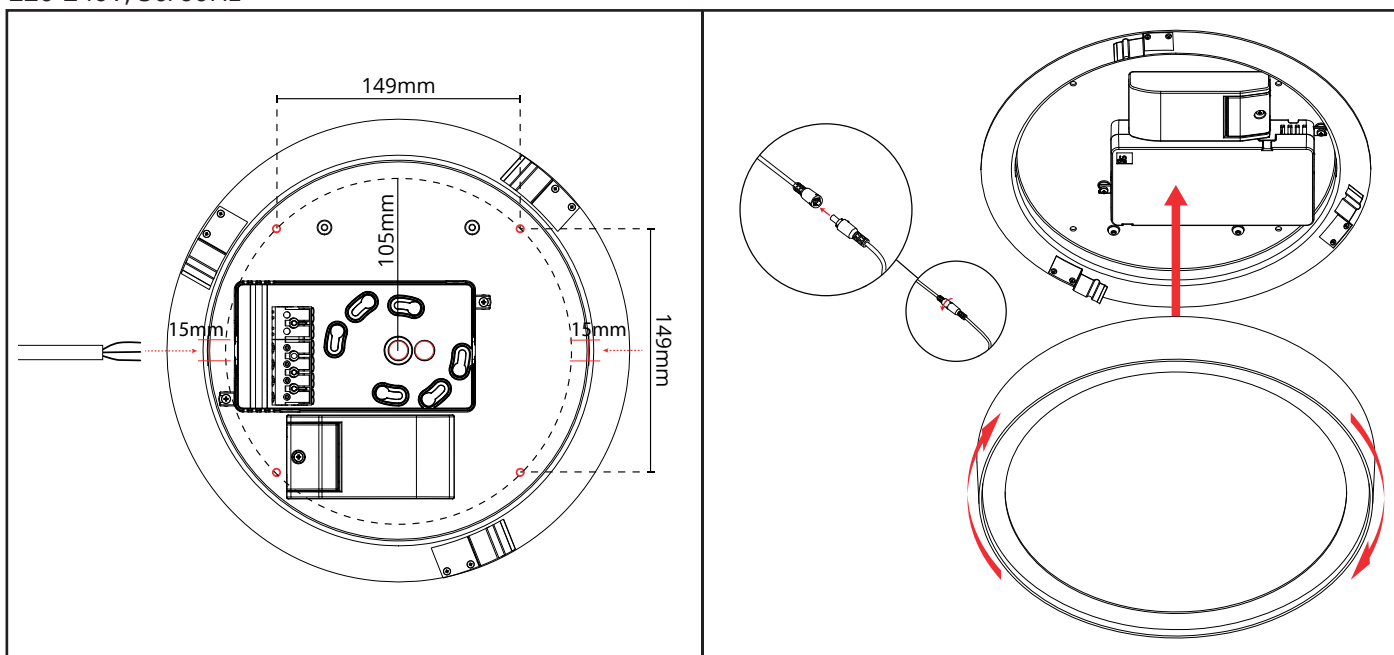

Fixed cable only

Dipswitch

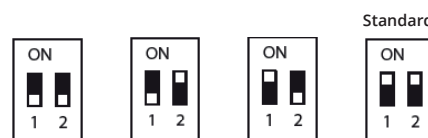

	ON	ON	ON	Standard
	1	2	1	2
mA	300	350	400	450
lm	67%	78%	89%	100%

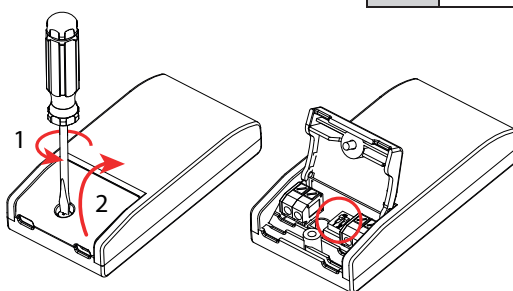

NO: Skru av strømmen før montering.
EN: Turn off power before installing.
FR: Couper le courant avant l'installation.
NL: Stroom uitschakelen voor u het toestel installeert.
DE: Vor Installationsarbeiten den Strom abschalten.
FI: Sammuta virta ennen kytkemistä



NO: Kan kun installeres av en registrert installasjonsvirksomhet.
EN: Only to be installed by an authorized electrician.
FR: Doit être installé par un électricien autorisé.
NL: Mag alleen geïnstalleerd worden door een bevoegde elektricien.
DE: Dieses Produkt darf nur durch autorisiertes Personal (z. B. Elektro-Installateur) angeschlossen und in Betrieb genommen werden.
FI: Asentaa saa vain valtuutettu sähköasentaja

NORWAY SG Armaturen AS
 Skytterheia 25
 N-4790 Lillesand
 Tel: +47 37 50 03 00
 firmapost@sg-as.no
 www.sg-as.no

SWEDEN SG Armaturen AB
 Tel: +46 31 81 71 10
 info@sg-ab.se
 www.sg-ab.se

FRANCE SG Lighting SA/NV
 Tel: +33(0) 4 94 93 00 00
 info.france@sglighting.fr
 www.sglighting.net

GERMANY SG Leuchten GmbH
 Tel: +49 40 23 99 44 59
 info@sg-leuchten.de
 www.sg-leuchten.de

FINLAND SG Armaturen Oy
 info@sg-oy.fi
 www.sg-oy.fi

DENMARK SG Armaturen A/S
 Tel: +45 70 70 72 13
 info@sg-as.dk
 www.sg-as.dk

BENELUX SG Lighting SA/NV
 Tel: +32(0) 15 20 72 71
 info.benelux@sglighting.net
 www.sglighting.net

INTERNATIONAL SG Lighting Co Ltd.
 Tel: +86 769 88 49 20 88
 cindy@sgdgc.com
 www.sg-as.com

Motion sensor

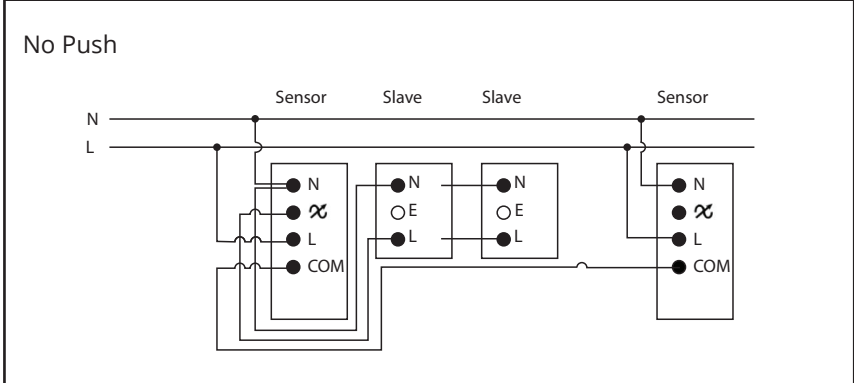
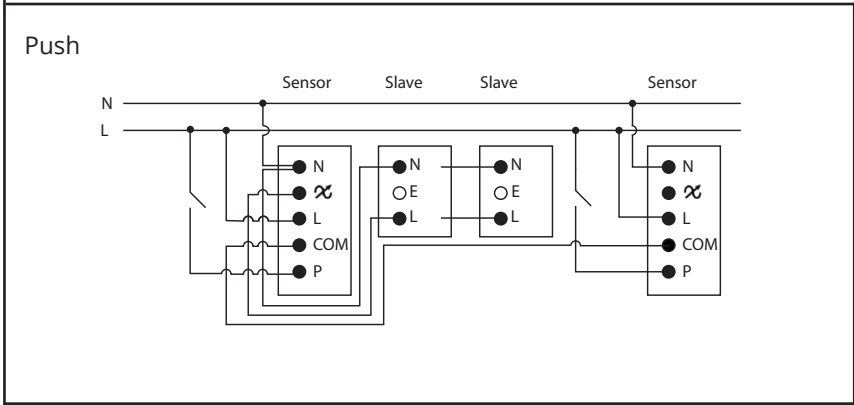
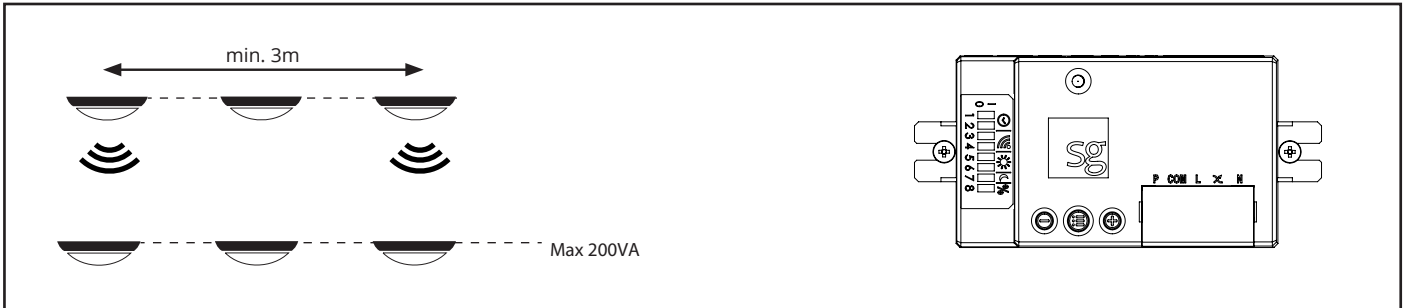

⌚	Hold time		1	2
		10 minutes	1	1
		5 minutes	0	1
		1 minute	1	0
📶	Motion sensitivity		3	4
		High	1	1
		Medium	0	1
		Low	1	0
☀️	Daylight sensitivity		5	6
		Low	1	1
		Medium	0	1
		High	1	0
🌙	Midnight cut	On	1	
		Off	0	
%	Basic light		8	
		On	1	
Off	0			

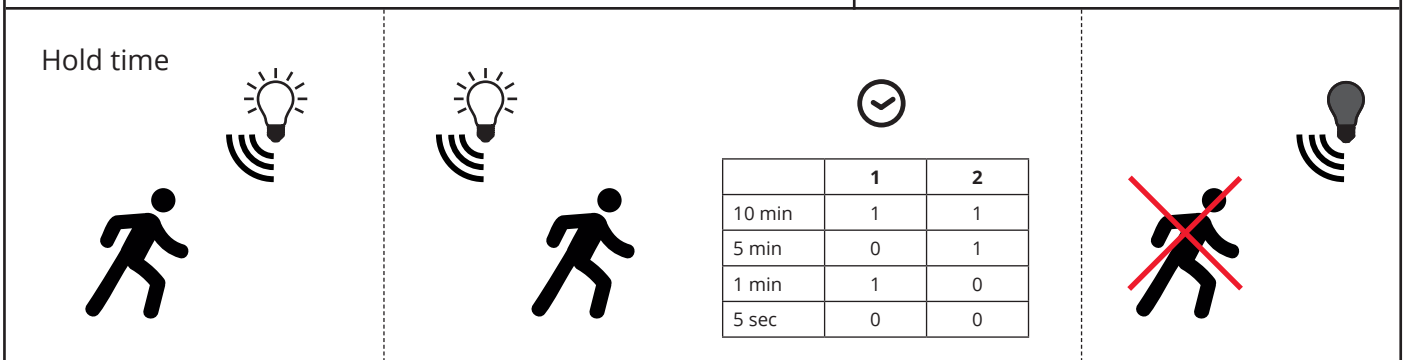

NORWAY
SG Armaturen AS

Skytterheia 25
N-4790 Lillesand

Tel: +47 37 50 03 00
firmapost@sg-as.no
www.sg-as.no

SWEDEN

SG Armaturen AB
Tel: +46 31 81 71 10
info@sg-ab.se
www.sg-ab.se

FINLAND

SG Armaturen Oy
info@sg-oy.fi
www.sg-oy.fi

DENMARK

SG Armaturen A/S
Tel: +45 70 70 72 13
info@sg-as.dk
www.sg-as.dk

UNITED KINGDOM

SG Lighting LTD
Tel: +47 37 50 03 00
info@sglighting.co.uk
www.sglighting.co.uk

FRANCE

SG Lighting SA/NV
Tel: +33(0) 4 94 93 00 00
info.france@sglighting.fr
www.sglighting.net

BENELUX

SG Lighting SA/NV
Tel: +32(0) 15 20 72 71
info.benelux@sglighting.net
www.sglighting.net

GERMANY

SG Leuchten GmbH
Tel: +49 40 23 99 44 59
info@sg-leuchten.de
www.sg-leuchten.de

INTERNATIONAL

SG Lighting Co Ltd.
Tel: +86 769 88 49 20 88
cindy@sgdgc.com
www.sg-as.com

Motion sensitivity

	3	4
High	1	1
Medium	0	1
Low	1	0
Off	0	0

1

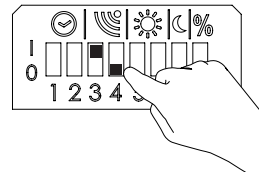

2

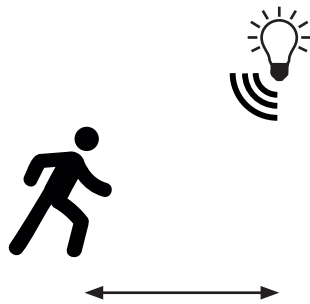
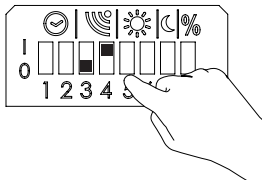

3

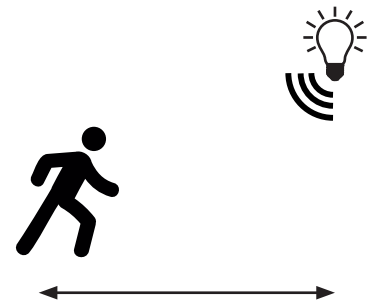
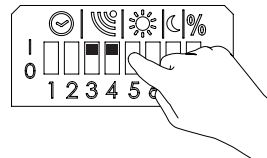

Light levels - Basic light and max light

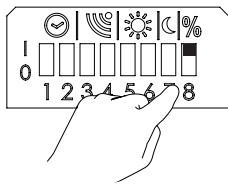

1

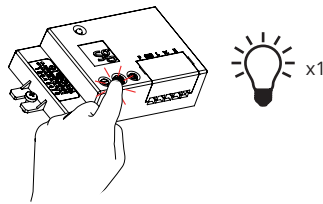

2

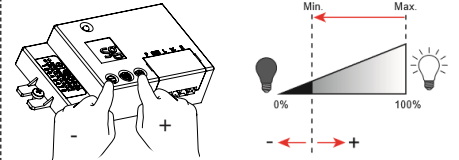

Basic light

3

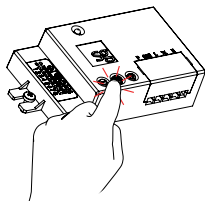

4

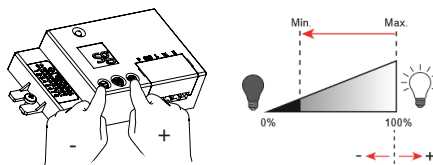

Maximum light level

5

