

LE1 D --	220/230V		380/400V		415V		440V		500V		LR2D....	aM A
	kW	HP/Ch	kW	HP/Ch	kW	HP/Ch	kW	HP/Ch	kW	HP/Ch		
09	—	—	—	—	—	—	0.37	0.5	0.37	0.5	1305	2
09	—	—	0.37	0.5	—	—	0.55	0.75	0.75	0.75	1306	2
09	0.37	0.5	0.75	1	1.1	1.5	1.1	1.5	1.1	1.5	1307	4
09	0.75	1	1.5	2	1.5	2	1.5	2	2.2	3	1308	6
09	1.1	1.5	2.2	3	2.2	3	2.2	3	3.7	5	1310	8
09	1.5	2	3	4	3.7	5	3.7	5	4	5.5	1312	12
09	2.2	3	4	5.5	4	5.5	4	5.5	5.5	7.5	1314	12
12	3	4	5.5	7.5	5.5	7.5	5.5	7.5	7.5	10	1316	16

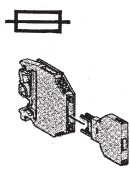

AB1-SF435U
+
AB1-PS4
+
AB1-SF520

⊗	110V	LA9-D924
	220V	LA9-D925
	380V	LA9-D926

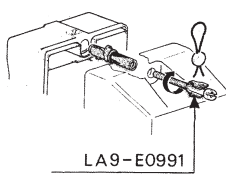
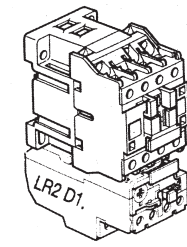
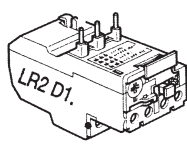
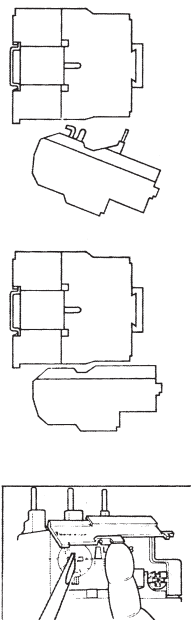
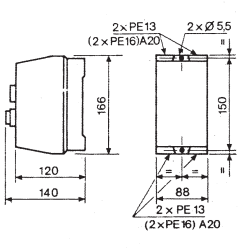
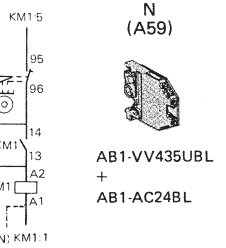
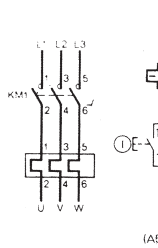
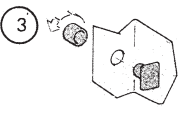
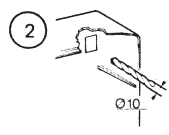
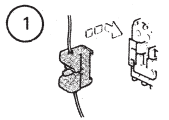

A04

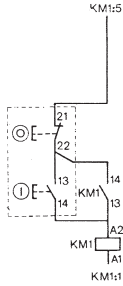
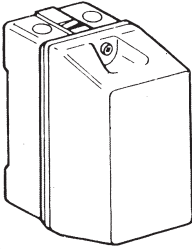

A05

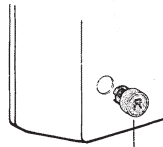

ZA2-BA639

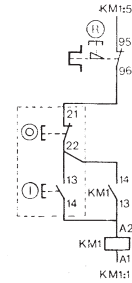

A09

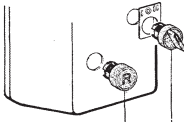

ZA2-BA639
ZA2-BD3

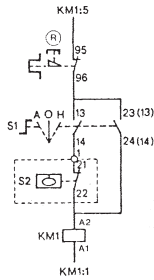

A13

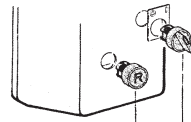

ZA2-BA639
ZA2-BD2

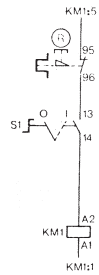

LA9-D0910

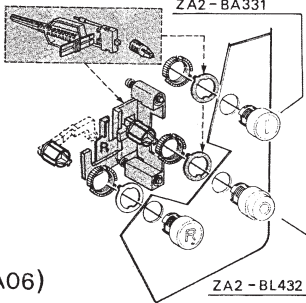

(A06)

ZA2-BA331

ZA2-BL432

LA9-D0935

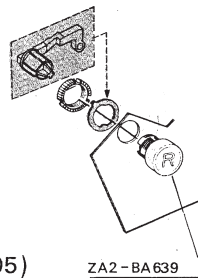

(A05)

ZA2-BA639

LA9-D1275

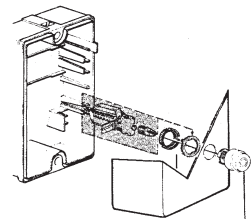

(A07)

ZA2-BL432

