

VLR-247RL3911

SICK
Sensor Intelligence.



Illustration may differ

Ordering information

Type	Part no.
VLR-247RL3911	2134620

Other models and accessories → www.sick.com/

Detailed technical data

Technical specifications

Accessory group	Illuminations
Accessory family	LED
Description	Ring Light
Ambient operating temperature	0 °C ... +40 °C ¹⁾
Storage temperature	-20 °C ... +60 °C
Light source	LED, blue, 470 nm
Illuminated field	Ø 32 mm
LED class	Risk group 1 (low risk, IEC62471 : 2008)
Trigger input signal	24 V DC High = Light ON
Supply voltage	24 V DC
Current consumption	0.23 A
Connections	Connector M12, 4-pin, L = 0.5 m
Note	Not free of paint wetting impairment substances.

¹⁾ Light intensity may vary depending on the ambient temperature.

Classifications

ECLASS 5.0	27110635
ECLASS 5.1.4	27110635
ECLASS 6.0	27110635
ECLASS 6.2	27110635
ECLASS 7.0	27110635
ECLASS 8.0	27110635
ECLASS 8.1	27110635
ECLASS 9.0	27110635
ECLASS 10.0	27110635
ECLASS 11.0	27110635
ECLASS 12.0	27110635
ETIM 5.0	EC000996
ETIM 6.0	EC000996
ETIM 7.0	EC000996

ETIM 8.0	EC000996
UNSPSC 16.0901	39101628

Dimensional drawing (Dimensions in mm (inch))

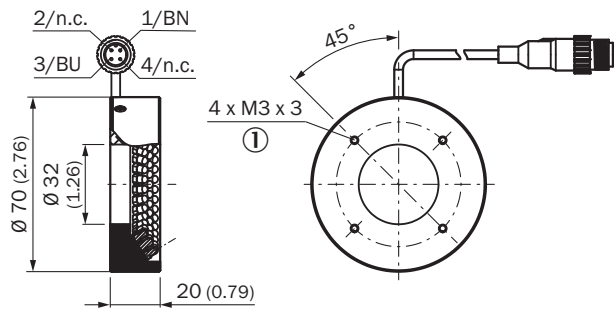

① For installation; pitch circle diameter 50 mm

SICK AT A GLANCE

SICK is one of the leading manufacturers of intelligent sensors and sensor solutions for industrial applications. A unique range of products and services creates the perfect basis for controlling processes securely and efficiently, protecting individuals from accidents and preventing damage to the environment.

We have extensive experience in a wide range of industries and understand their processes and requirements. With intelligent sensors, we can deliver exactly what our customers need. In application centers in Europe, Asia and North America, system solutions are tested and optimized in accordance with customer specifications. All this makes us a reliable supplier and development partner.

Comprehensive services complete our offering: SICK LifeTime Services provide support throughout the machine life cycle and ensure safety and productivity.

For us, that is “Sensor Intelligence.”

WORLDWIDE PRESENCE:

Contacts and other locations –www.sick.com