

Part number

# TAPW 10.25



Surface mounting housing, T-TYPE /W series,  
with 2 levers, M25 cable entry, size "57.27"

Product description		Material properties	
<b>Product type</b>	Surface mounting housing	<b>Main material</b>	Polypropylene (PP)
<b>Series</b>	T-TYPE /W	<b>Other materials</b>	Lever: Polyamide (PA) Gasket: FKM
<b>Closing type</b>	With 2 levers	<b>Colour</b>	RAL 7012 grey, RAL 7001 grey
<b>Size</b>	Size 57.27	<b>RoHs conformity</b>	Compliant
<b>Cable entry</b>	With cable entry M25	<b>China RoHs - EFUP</b>	E
Technical data		<b>REACH SVHC substances</b>	No
<b>IP degree of protection</b>	IP66 / IP69	Approvals / Standards	
Further technical details		<b>UL</b>	ECBT2
<b>Weight</b>	169,00 g	<b>cUL</b>	ECBT8
<b>Operating temperature range (min, max)</b>	-40°C ... +90°C	General ordering information	
		<b>EAN13 code</b>	8015747211703
		<b>eCl@ss 8.1</b>	27440202
		<b>ETIM 7.0</b>	EC000437
		Packaging Information	
		<b>Packaging length</b>	310,00 mm
		<b>Packaging height</b>	220,00 mm
		<b>Packaging width</b>	240,00 mm
		<b>Packaging weight</b>	3,67 kg
		<b>Packaging volume</b>	16,37 dm <sup>3</sup>
		<b>Packaging description</b>	Carton box
		<b>Packaging quantity</b>	20 Pcs
		<b>Packaging EAN code</b>	8015747211802
		<b>Sub-packaging weight</b>	0,92 kg
		<b>Sub-packaging description</b>	Plastic packaging
		<b>Sub-packaging quantity</b>	5 Pcs
		<b>Sub-packaging EAN barcode</b>	8015747211819

Part number

# TAPW 10.25



## Catalogue drawings

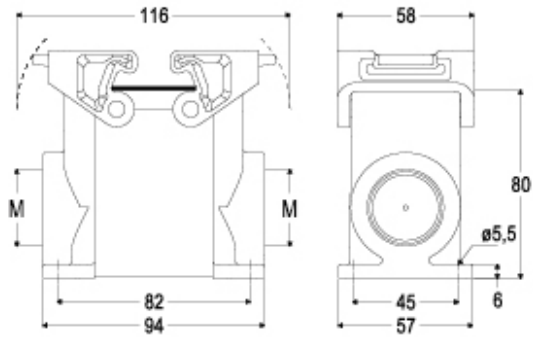

---

## Notes

Dimensions shown in mm are not binding and may be changed without notice.

---