

## HW1

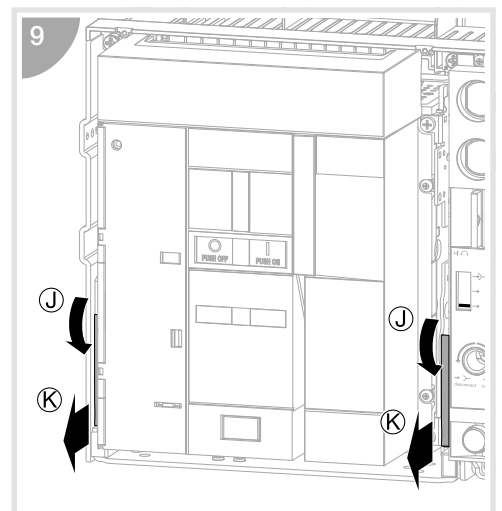

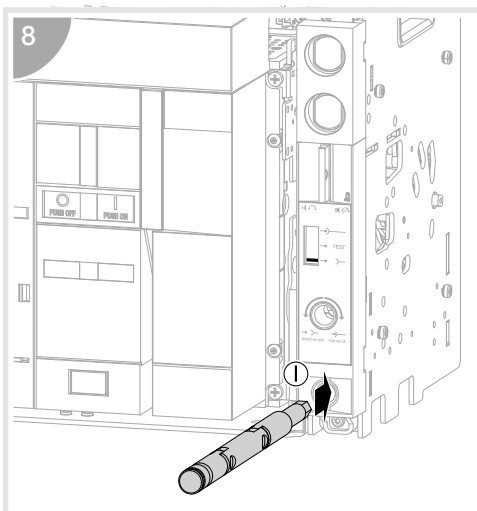

	3P	4P
A (mm)	180	250

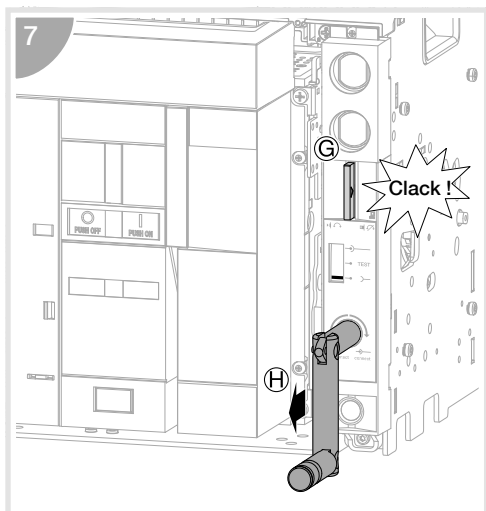
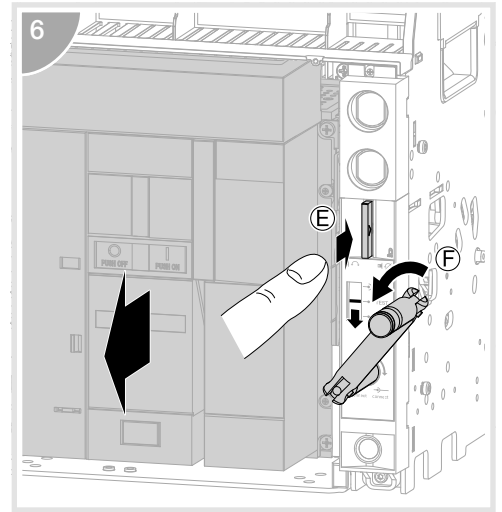
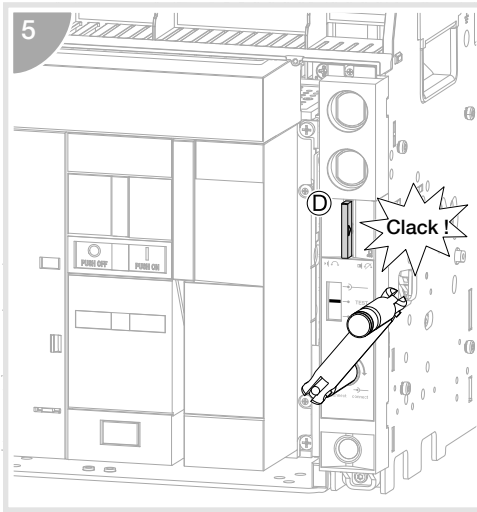
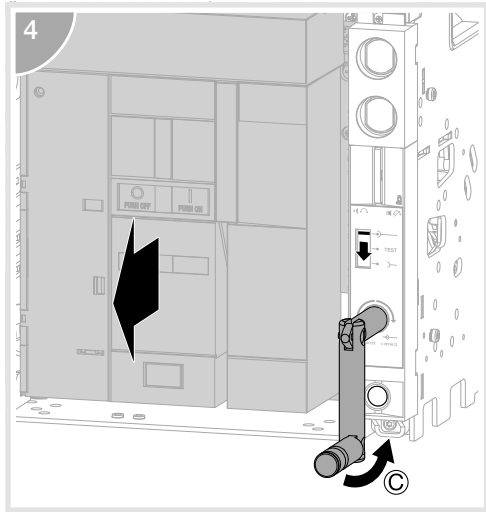
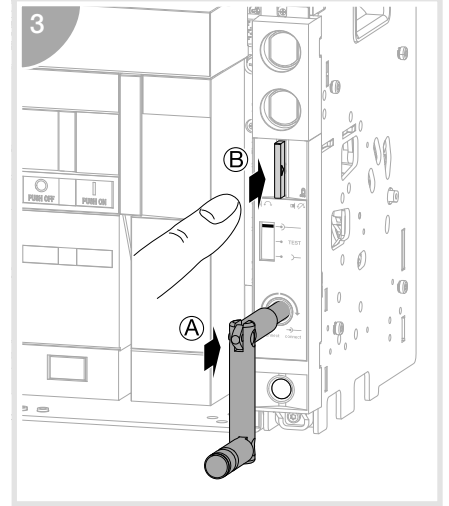
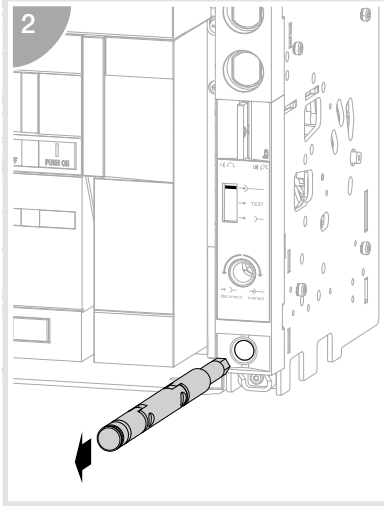
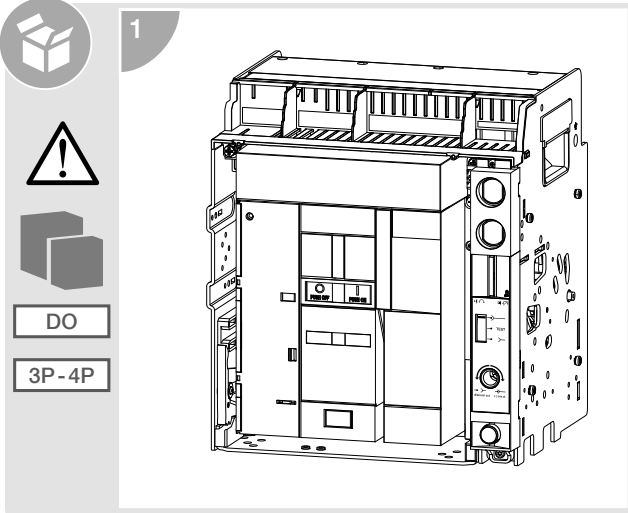
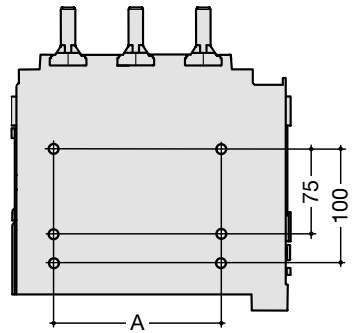
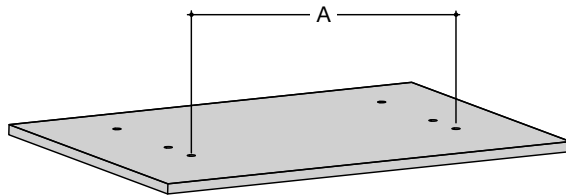
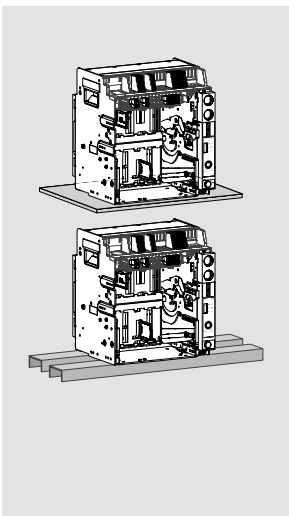
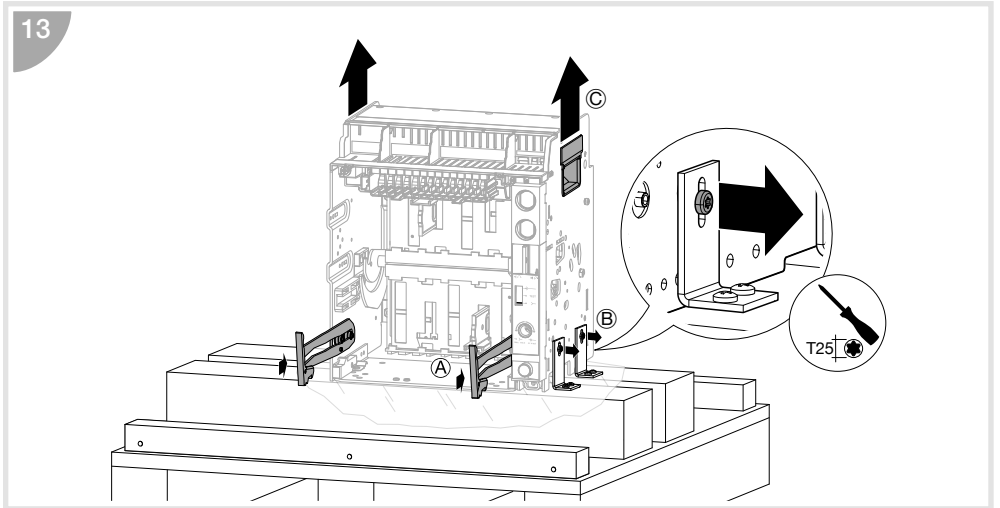
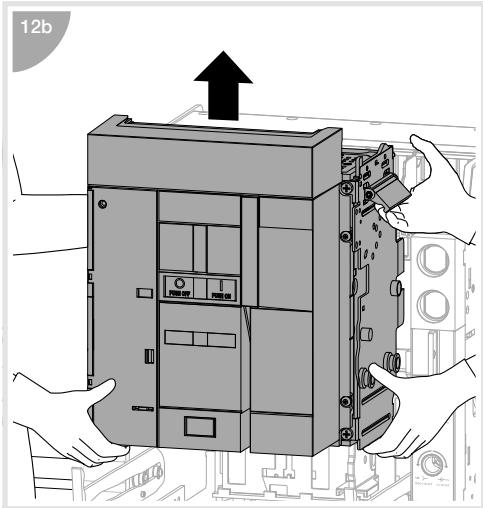
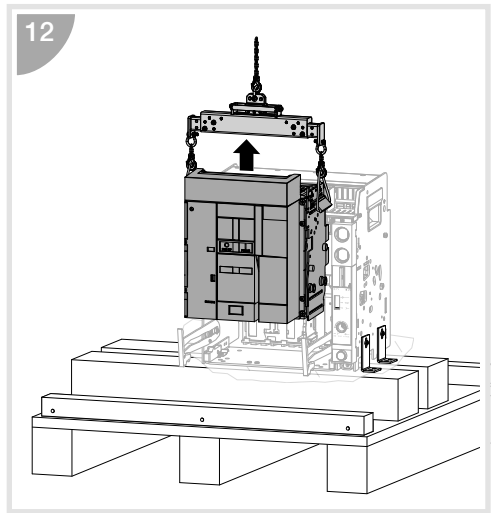
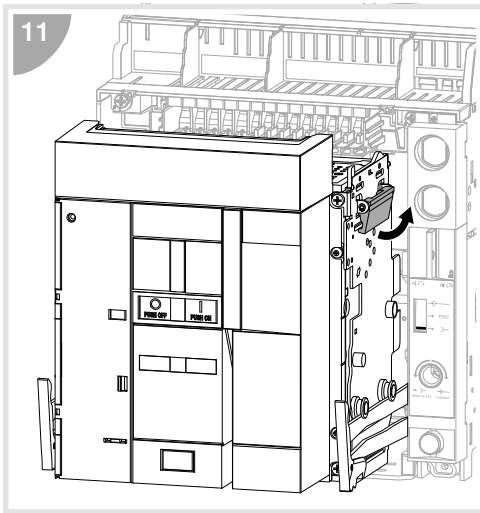
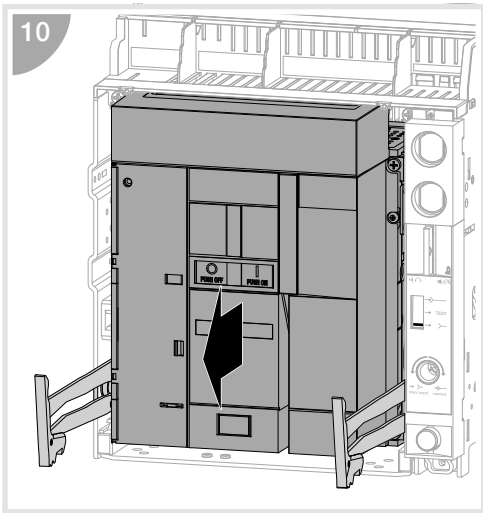
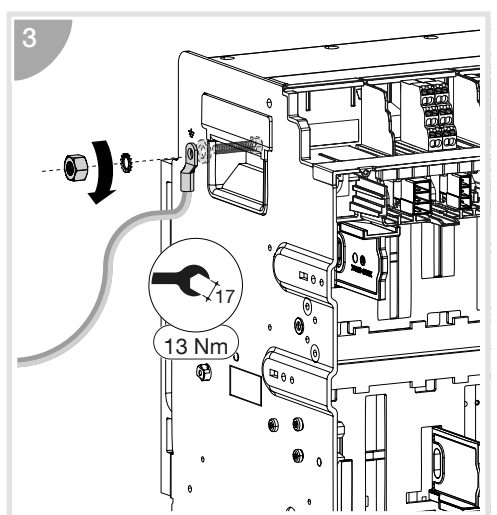
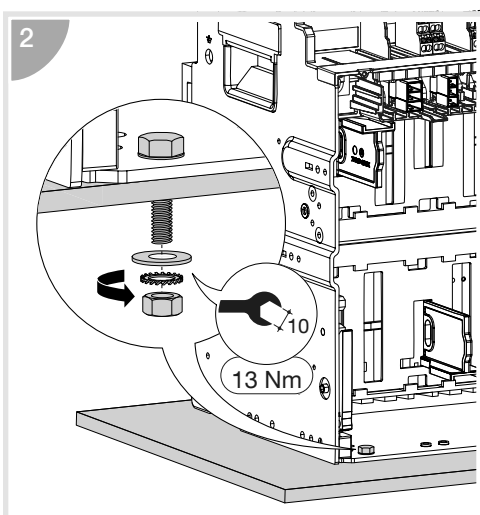
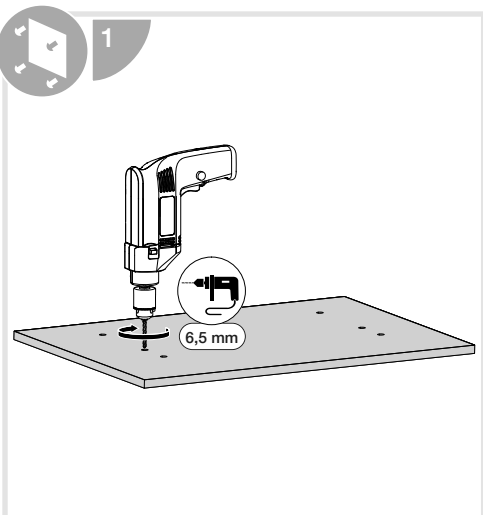

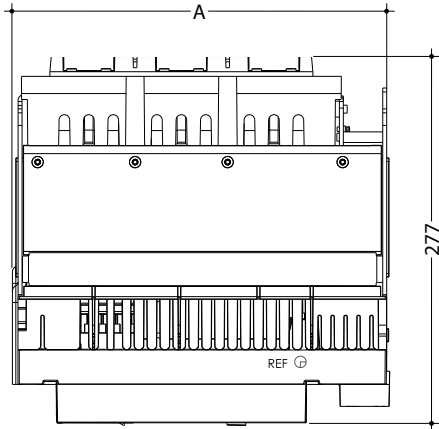
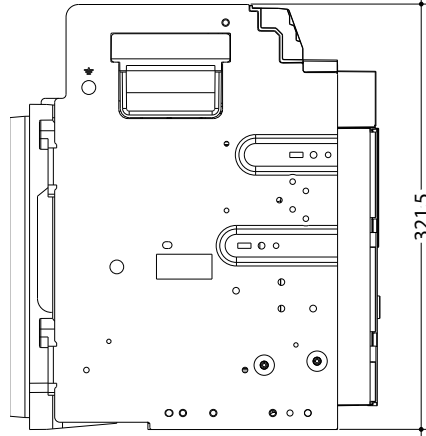
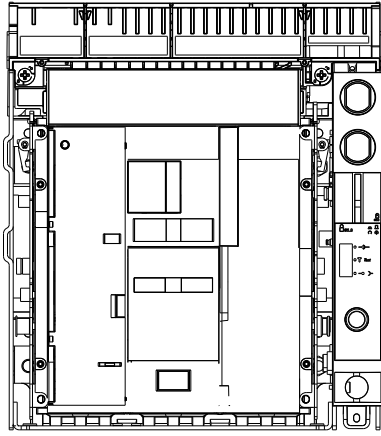

	3P	4P
A (mm)	283,1	348.8

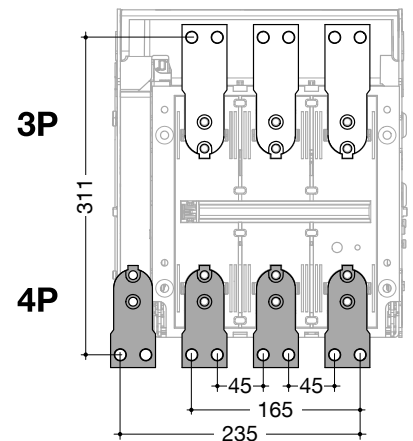
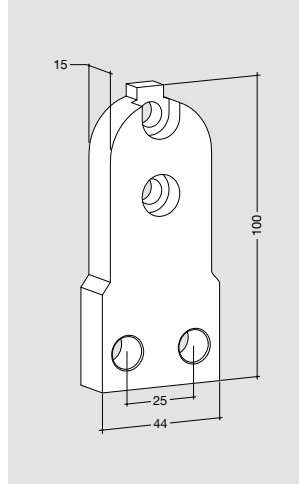
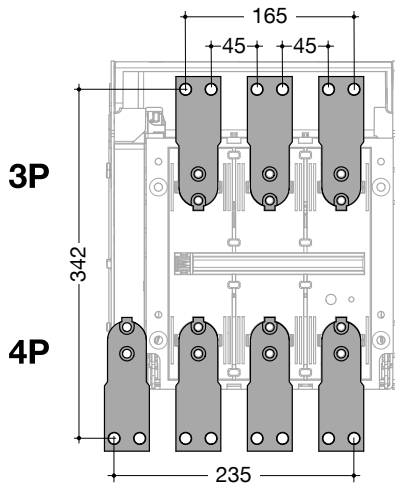
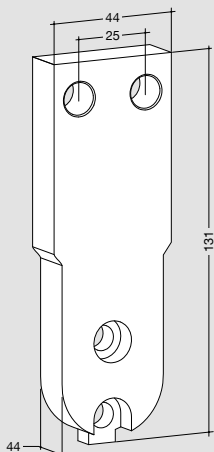
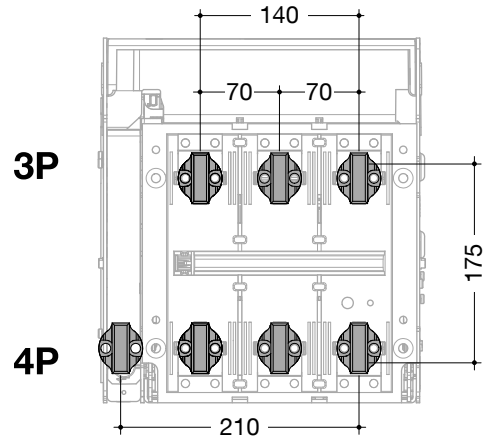
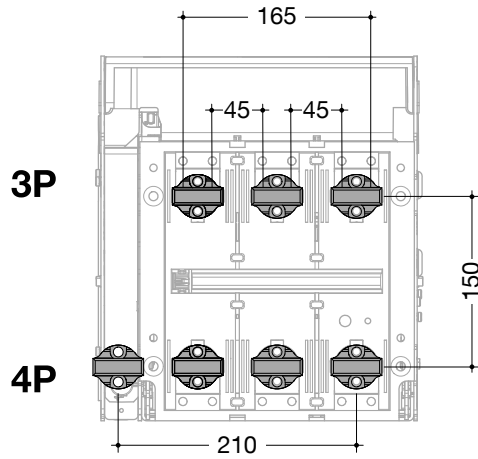
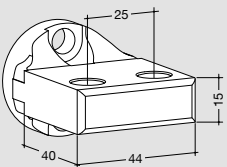

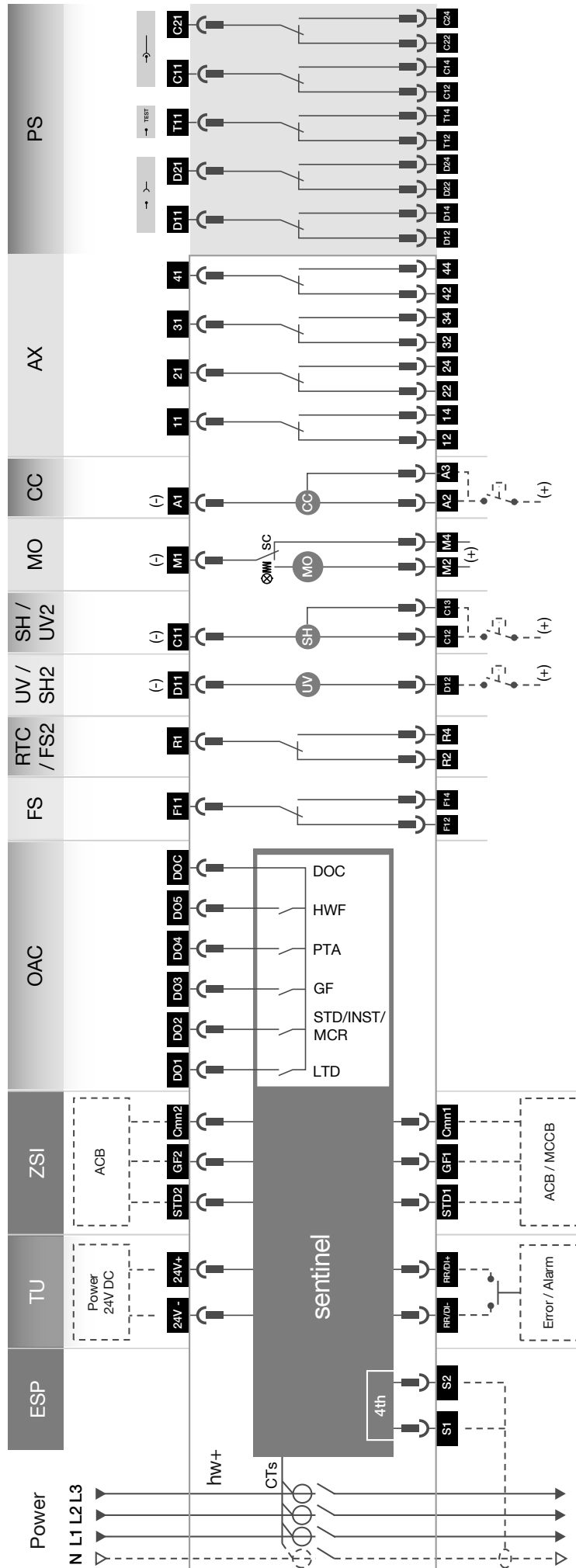



1



FIX

3P-4P

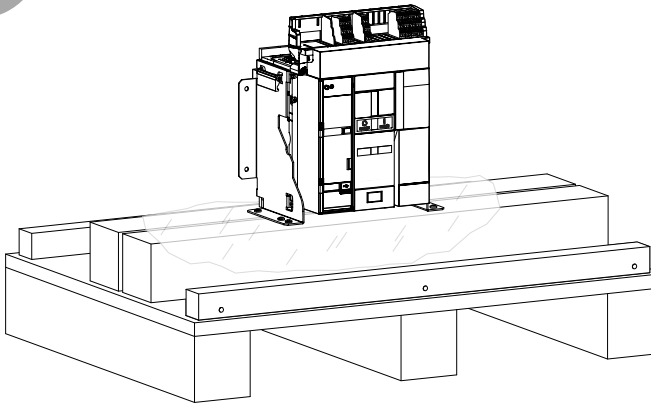

2

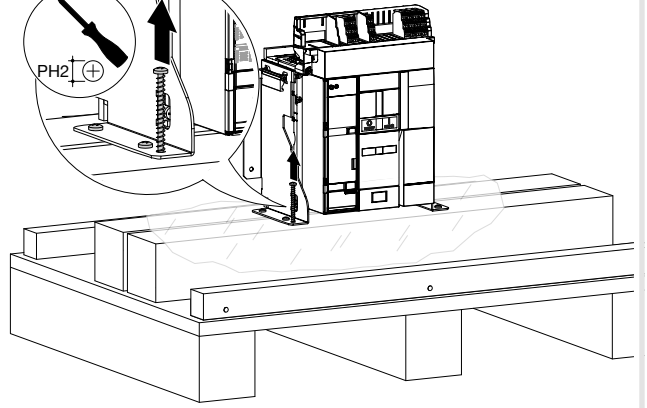
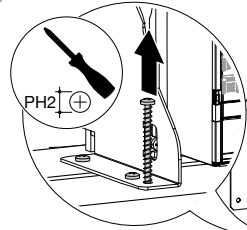

3

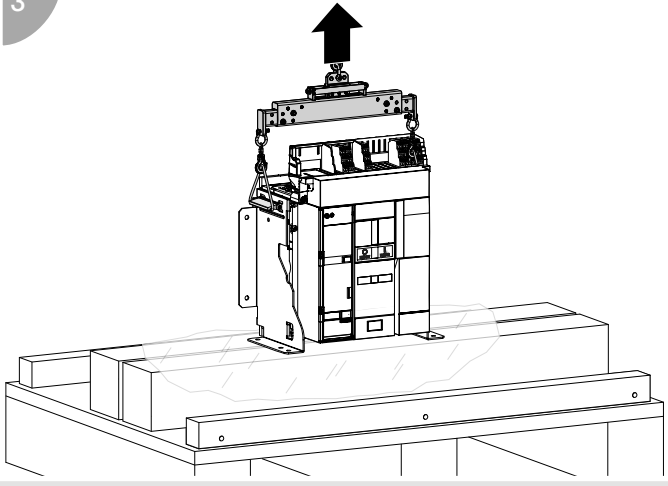

3b

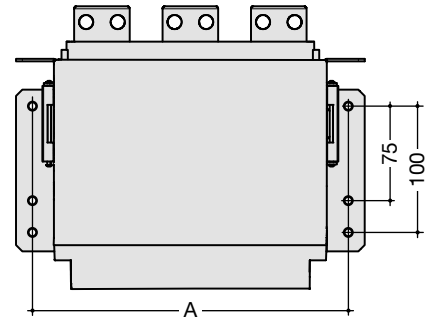
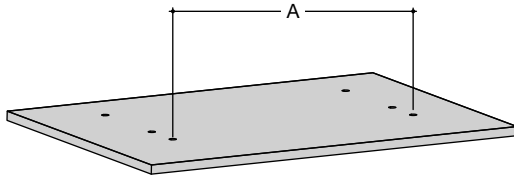
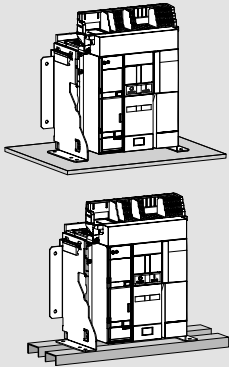
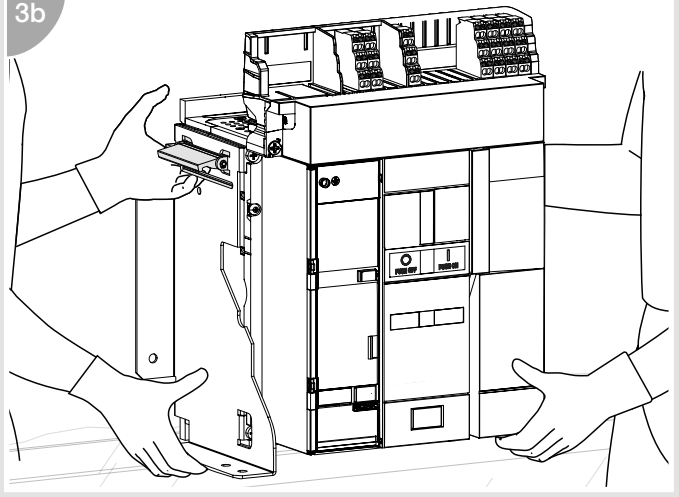

	3P	4P
A (mm)	180	250



1

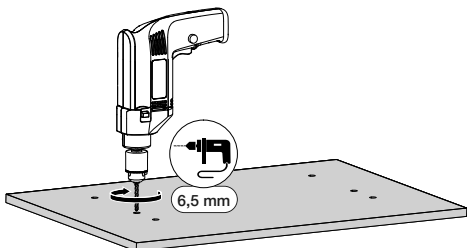

2

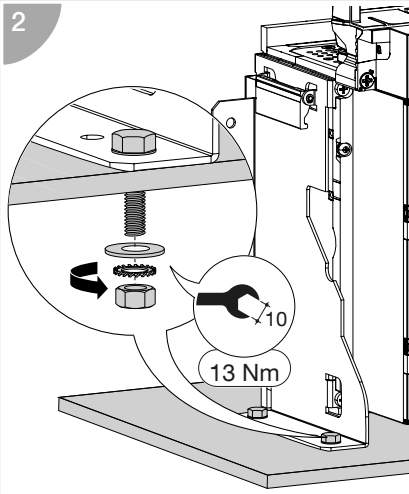

3

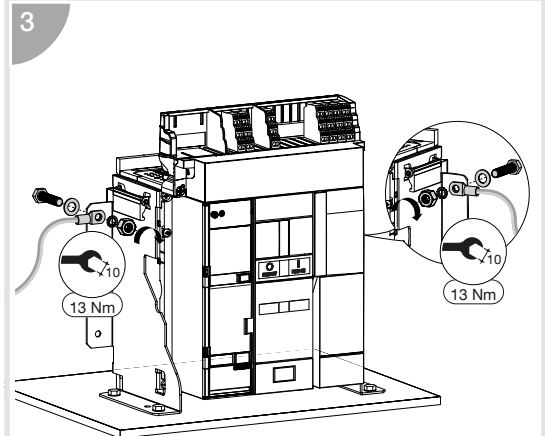

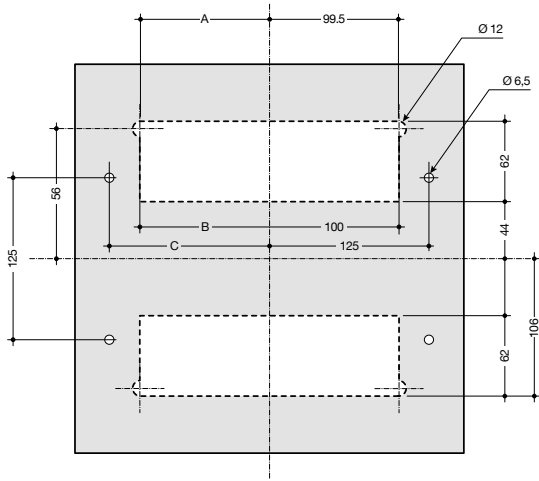
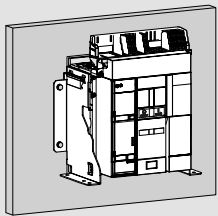

	3P	4P
A (mm)	99,5	169,5
B (mm)	100	170
C (mm)	125	195

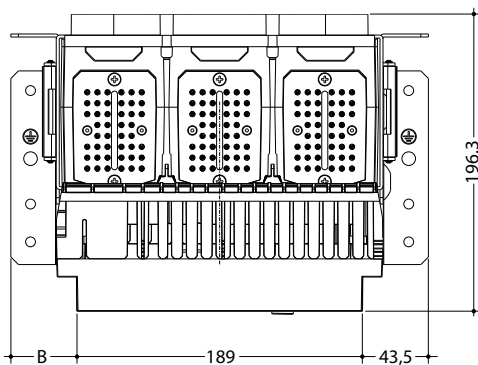
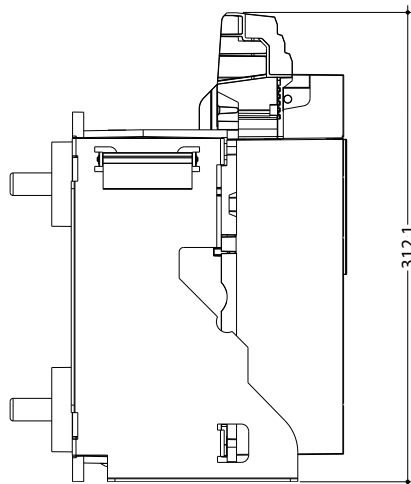
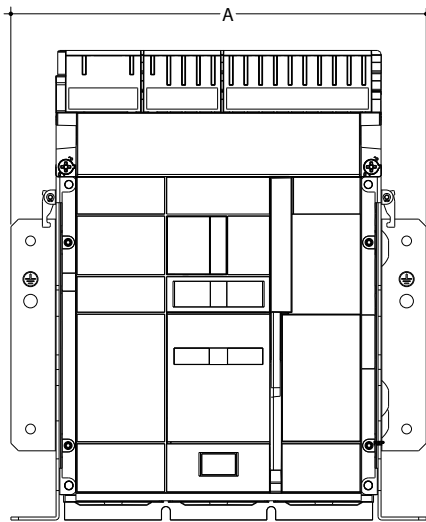
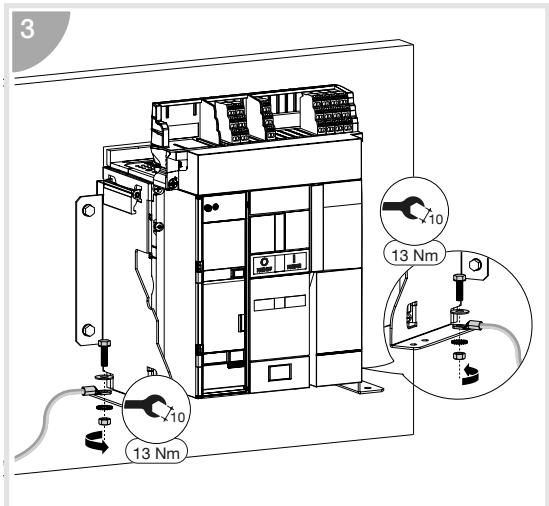
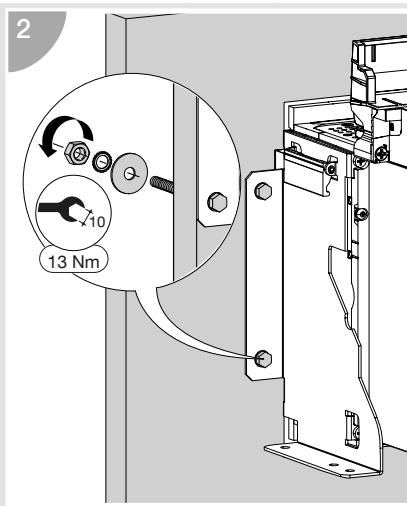
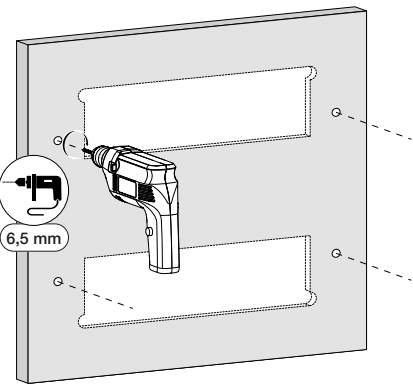

	3P	4P
A (mm)	276	346
B (mm)	43,5	113,5

