



# MLG05W-0343R12503

MLG-2 WebChecker

MEASURING AUTOMATION LIGHT GRIDS

**SICK**  
Sensor Intelligence.



Illustration may differ



### Ordering information

Type	Part no.
MLG05W-0343R12503	1130878

Other models and accessories → [www.sick.com/MLG-2\\_WebChecker](http://www.sick.com/MLG-2_WebChecker)

### Detailed technical data

#### Features

<b>Device version</b>	Web guiding
<b>Sensor principle</b>	Sender/receiver
<b>Minimum object length</b>	4 mm <sup>1)</sup>
<b>Beam separation</b>	5 mm
<b>Resolution</b>	0.1 mm
<b>Cycle time</b>	32 µs per beam
<b>Repeatability</b>	6 µm <sup>2)</sup>
<b>Accuracy</b>	± 0.3 mm <sup>3)</sup>
<b>Type of synchronization</b>	Cable
<b>Number of beams</b>	180
<b>Total measuring field width</b>	1,495 mm
<b>Measuring field width detailed</b>	
Measuring field width (connection side)	445 mm
Blind zone (medium range)	605 mm
Measuring field width (head side)	445 mm
<b>Software features (default)</b>	
Q <sub>1</sub> /C	Alarm, general
Q <sub>2</sub>	Standard teach-in
Q <sub>3</sub>	Edge position 1

<sup>1)</sup> See graphic: product definition.

<sup>2)</sup> 1 sigma, 0% object transmission (sensor internal value).

<sup>3)</sup> For opaque objects and exact alignment of sender/receiver.

	Q <sub>4</sub>	Edge position 10
	Application	High resolution mode
<b>Included with delivery</b>		1 × sender 1 × receiver 4/6 × QuickFix brackets (6 × QuickFix brackets for monitoring heights above 2 m) 1 × Quick Start Guide

<sup>1)</sup> See graphic: product definition.

<sup>2)</sup> 1 sigma, 0% object transmission (sensor internal value).

<sup>3)</sup> For opaque objects and exact alignment of sender/receiver.

## Mechanics/electronics

<b>Light source</b>	LED, Infrared light
<b>Wave length</b>	850 nm
<b>Supply voltage V<sub>s</sub></b>	DC 19.2 V ... 28.8 V <sup>1)</sup>
<b>Power consumption sender</b>	64 mA <sup>2)</sup>
<b>Power consumption receiver</b>	156 mA <sup>2)</sup>
<b>Ripple</b>	< 5 V <sub>pp</sub>
<b>Output current I<sub>max.</sub></b>	100 mA
<b>Output load, capacitive</b>	100 nF
<b>Output load, Inductive</b>	1 H
<b>Initialization time</b>	< 1 s
<b>Switching output</b>	Push-pull: PNP/NPN
<b>Dimensions (W x H x D)</b>	34 mm x 1,579.4 mm x 30.6 mm
<b>Connection type</b>	Male connector M12, 5-pin, 0.22 m Male connector M12, 8-pin, 0.27 m M12 female connector, 4-pin, D-coded, 0.19 m
<b>Housing material</b>	Aluminum
<b>Indication</b>	LED
<b>Enclosure rating</b>	IP65, IP67 <sup>3)</sup>
<b>Circuit protection</b>	U <sub>V</sub> connections, reverse polarity protected Output Q short-circuit protected Interference pulse suppression
<b>Protection class</b>	III
<b>Weight</b>	3.259 kg
<b>Front screen</b>	PMMA
<b>Option</b>	None
<b>UL File No.</b>	NRKH.E181493

<sup>1)</sup> Without load.

<sup>2)</sup> , Without load with 24 V.

<sup>3)</sup> Operating in outdoor condition only with a external protection housing.

## Performance

<b>Maximum range</b>	3.5 m <sup>1)</sup>
----------------------	---------------------

<sup>1)</sup> No reserve for environmental issue and deterioration of the diode.

<sup>2)</sup> With resistive load.

<b>Minimum range</b>	≥ 0.2 m
<b>Operating range</b>	2.5 m
<b>Response time</b>	36.7 ms <sup>2)</sup>

<sup>1)</sup> No reserve for environmental issue and deterioration of the diode.

<sup>2)</sup> With resistive load.

### Communication interface

<b>IO-Link</b>	✓, IO-Link V1.1
Data transmission rate	230,4 kbit/s (COM3)
Maximum cable length	20 m
Cycle time	14 ms
VendorID	26
DeviceID HEX	80022F
DeviceID DEC	8389167
Process data length	32 Byte (TYPE_2_V) <sup>1)</sup>
<b>Inputs/outputs</b>	4 x Q (IO-Link)
<b>Digital output</b>	Q <sub>1</sub> ... Q <sub>4</sub>
Number	4
<b>Digital input</b>	Q <sub>2</sub> , Q <sub>3</sub> , Q <sub>4</sub>
Number	3

<sup>1)</sup> With an IO-Link master with V1.0, fall back to interleaved mode (consisting of TYPE\_1\_1 (ProcessData) and TYPE\_1\_2 (On-request Data)).

### Ambient data

<b>Shock resistance</b>	Continuous shocks 10 g, 16 ms, 1000 shocks Single shocks 15 g, 11 ms 3 per axle
<b>Vibration resistance</b>	Sinusoidal oscillation 10-150 Hz 5 g
<b>Ambient light immunity</b>	100,000 lx
<b>Ambient operating temperature</b>	-30 °C ... +55 °C
<b>Ambient temperature, storage</b>	-40 °C ... +70 °C

### Classifications

<b>ECLASS 5.0</b>	27270910
<b>ECLASS 5.1.4</b>	27270910
<b>ECLASS 6.0</b>	27270910
<b>ECLASS 6.2</b>	27270910
<b>ECLASS 7.0</b>	27270910
<b>ECLASS 8.0</b>	27270910
<b>ECLASS 8.1</b>	27270910
<b>ECLASS 9.0</b>	27270910
<b>ECLASS 10.0</b>	27270910
<b>ECLASS 11.0</b>	27270910
<b>ECLASS 12.0</b>	27270910
<b>ETIM 5.0</b>	EC002549
<b>ETIM 6.0</b>	EC002549

<b>ETIM 7.0</b>	EC002549
<b>ETIM 8.0</b>	EC002549
<b>UNSPSC 16.0901</b>	39121528

Dimensional drawing (Dimensions in mm (inch))

Dimensional drawing

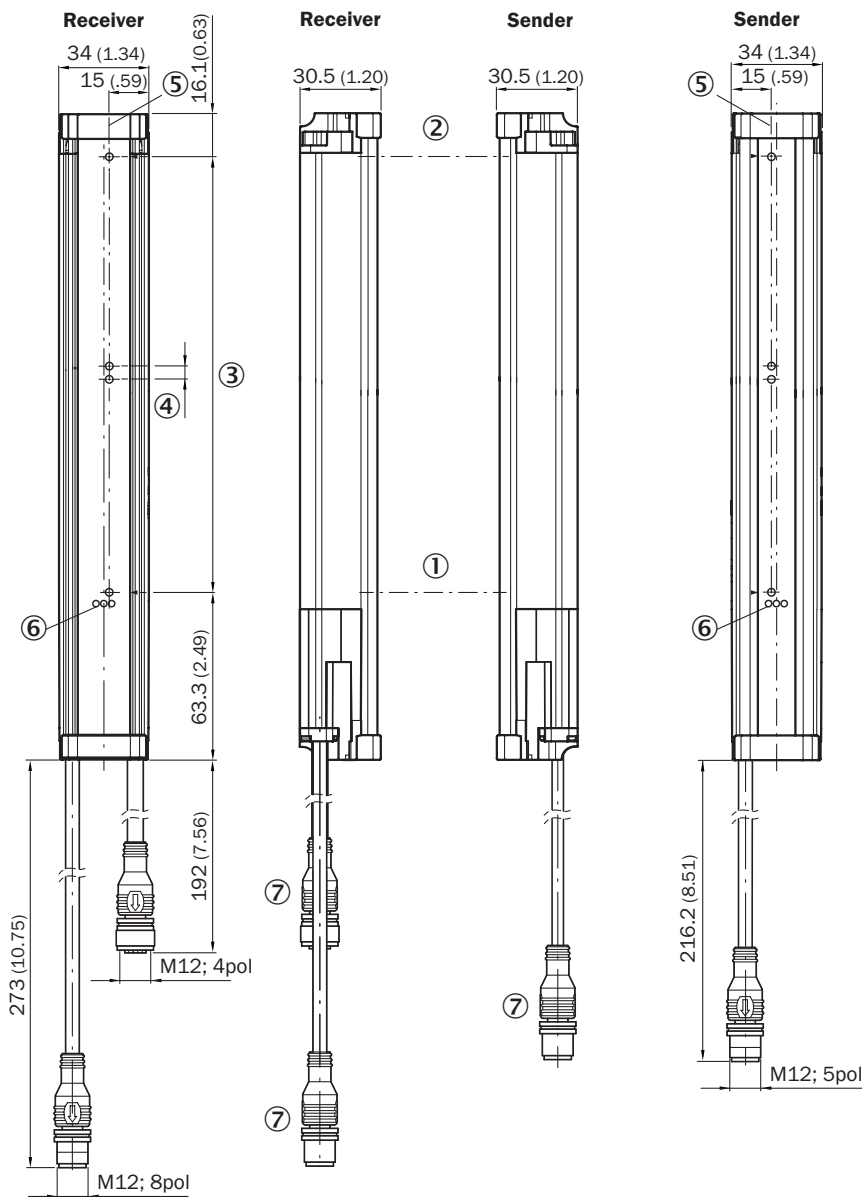

- ① First beam
- ② Last beam
- ③ Total measuring field width (see technical data)
- ④ Beam separation
- ⑤ Optical axis
- ⑥ Status indicator: green, yellow, red LEDs
- ⑦ Connection

### Adjustments

Adjustments

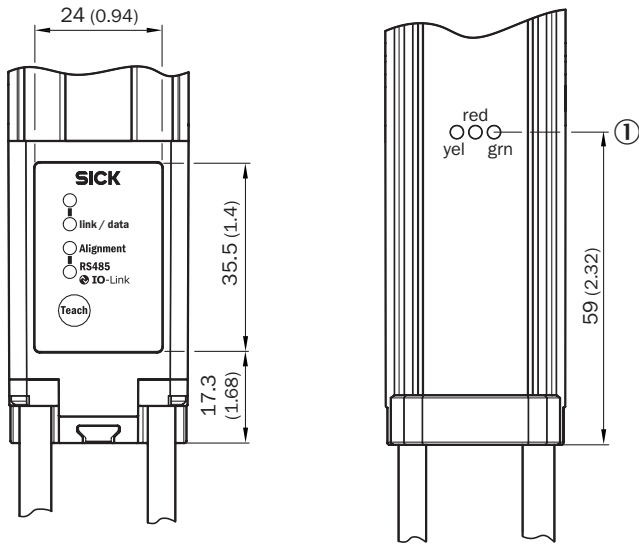

① Status indicator: green, yellow, red LEDs

### Connection type and diagram

MLG-2 WebChecker

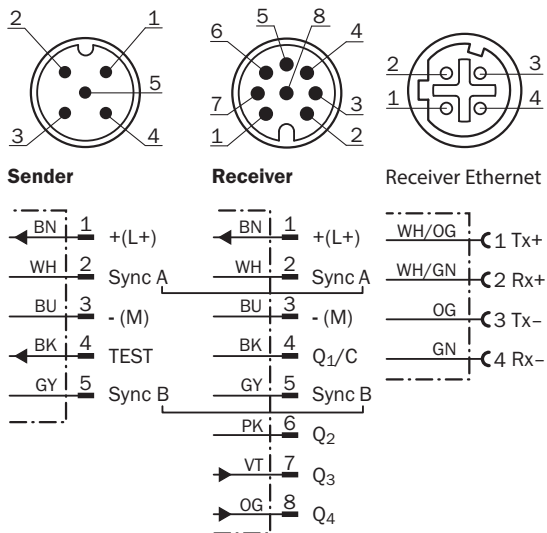

Connection diagram

T-piece

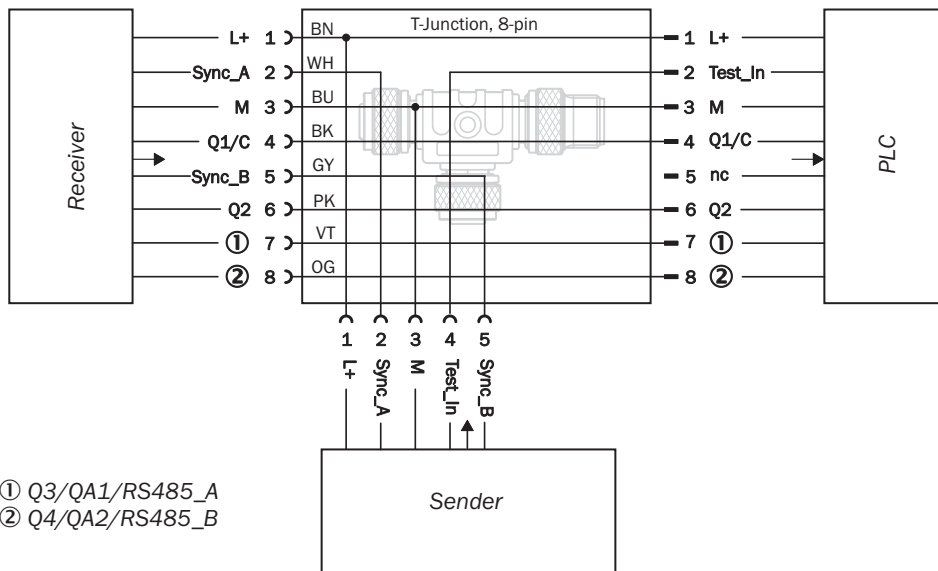

Product definition

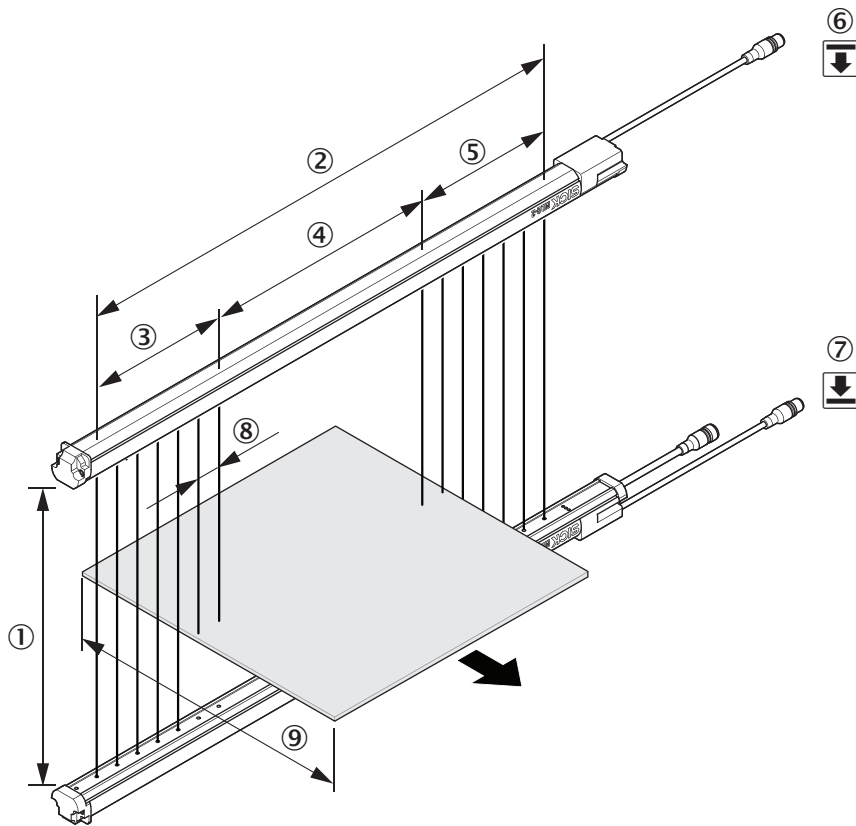







- ① Operating range
- ② Total measuring field width
- ③ Measuring field width (head side)
- ④ Blind zone (medium range)
- ⑤ Measuring field width (connection side)
- ⑥ Sender
- ⑦ Receiver
- ⑧ Beam separation
- ⑨ Minimum object length

Recommended accessories

Other models and accessories → [www.sick.com/MLG-2\\_WebChecker](http://www.sick.com/MLG-2_WebChecker)

	Brief description	Type	Part no.
Distributors			
	<ul style="list-style-type: none"> <li>• <b>Connection type head A:</b> Female connector, M12, 5-pin, A-coded</li> <li>• <b>Connection type head B:</b> Female connector, M12, 8-pin, A-coded</li> <li>• <b>Connection type head C:</b> Male connector, M12, 8-pin, A-coded</li> <li>• <b>Note:</b> Male connector M12, 8-pin, to 1 x female connector M12, 8-pin, to 1 x female connector M12, 5-pin, for connecting of a PLC</li> </ul>	SBO-02F12-SM1	6053172



	Brief description	Type	Part no.
Plug connectors and cables			
	<ul style="list-style-type: none"> <li>• <b>Connection type head A:</b> Female connector, M12, 8-pin, straight</li> <li>• <b>Connection type head B:</b> Flying leads</li> <li>• <b>Signal type:</b> Sensor/actuator cable</li> <li>• <b>Cable:</b> 5 m, 8-wire, PVC</li> <li>• <b>Description:</b> Sensor/actuator cable, special color code, shielded</li> <li>• <b>Connection systems:</b> Flying leads</li> </ul>	DOL-1208-G05MF	6020664
	<ul style="list-style-type: none"> <li>• <b>Connection type head A:</b> Female connector, M12, 5-pin, straight, A-coded</li> <li>• <b>Connection type head B:</b> Male connector, M12, 5-pin, straight, A-coded</li> <li>• <b>Signal type:</b> Sensor/actuator cable</li> <li>• <b>Cable:</b> 2 m, 5-wire, PUR, halogen-free</li> <li>• <b>Description:</b> Sensor/actuator cable, unshielded</li> <li>• <b>Application:</b> Zones with oils and lubricants, Drag chain operation, Robot</li> </ul>	YF2A15-020UB5M2A15	2096009
	<ul style="list-style-type: none"> <li>• <b>Connection type head A:</b> Female connector, M12, 8-pin, straight, A-coded</li> <li>• <b>Connection type head B:</b> Male connector, M12, 8-pin, straight, A-coded</li> <li>• <b>Signal type:</b> Sensor/actuator cable</li> <li>• <b>Cable:</b> 2 m, 8-wire, PUR, halogen-free</li> <li>• <b>Description:</b> Sensor/actuator cable, shielded</li> <li>• <b>Application:</b> Zones with oils and lubricants, Drag chain operation</li> </ul>	YF2A28-020UA6M2A28	2096105
	<ul style="list-style-type: none"> <li>• <b>Connection type head A:</b> Male connector, M12, 4-pin, straight, D-coded</li> <li>• <b>Connection type head B:</b> Male connector, RJ45, 4-pin, straight</li> <li>• <b>Signal type:</b> Ethernet, PROFINET</li> <li>• <b>Cable:</b> 2 m, 4-wire, PUR, halogen-free</li> <li>• <b>Description:</b> Ethernet, PROFINET, shielded</li> <li>• <b>Application:</b> Drag chain operation, Zones with oils and lubricants</li> </ul>	YM2D24-020PN1MRJA4	2106182
Sensor Integration Gateway			
	<ul style="list-style-type: none"> <li>• <b>Further functions:</b> Web server integrated, USB connection for easy configuration of the SIG200 Sensor Integration Gateway with SOPAS ET, the engineering tool from SICK, logic editor is available for easy configuration of logic functions</li> <li>• <b>Connection CONFIG:</b> 1 x M8, 4-pin female connector, USB 2.0 (USB-A)</li> <li>• <b>Logic editor:</b> yes</li> <li>• <b>Communication interface:</b> IO-Link, USB, Ethernet, PROFINET, REST API</li> <li>• <b>Product category:</b> IO-Link Master</li> </ul>	SIG200-0A0412200	1089794
	<ul style="list-style-type: none"> <li>• <b>Further functions:</b> Web server integrated, USB connection for easy configuration of the SIG200 Sensor Integration Gateway with SOPAS ET, the engineering tool from SICK, logic editor is available for easy configuration of logic functions</li> <li>• <b>Connection CONFIG:</b> 1 x M8, 4-pin female connector, USB 2.0 (USB-A)</li> <li>• <b>Logic editor:</b> yes</li> <li>• <b>Communication interface:</b> IO-Link, USB, Ethernet, REST API</li> <li>• <b>Product category:</b> IO-Link Master</li> </ul>	SIG200-0A0G12200	1102605

## SICK AT A GLANCE

SICK is one of the leading manufacturers of intelligent sensors and sensor solutions for industrial applications. A unique range of products and services creates the perfect basis for controlling processes securely and efficiently, protecting individuals from accidents and preventing damage to the environment.

We have extensive experience in a wide range of industries and understand their processes and requirements. With intelligent sensors, we can deliver exactly what our customers need. In application centers in Europe, Asia and North America, system solutions are tested and optimized in accordance with customer specifications. All this makes us a reliable supplier and development partner.

Comprehensive services complete our offering: SICK LifeTime Services provide support throughout the machine life cycle and ensure safety and productivity.

For us, that is “Sensor Intelligence.”

## WORLDWIDE PRESENCE:

Contacts and other locations –[www.sick.com](http://www.sick.com)