



CLV691-0001

CLV69x

FIXED MOUNT BARCODE SCANNERS

**SICK**  
Sensor Intelligence.



### Ordering information

Type	Part no.
CLV691-0001	1056606

Other models and accessories → [www.sick.com/CLV69x](http://www.sick.com/CLV69x)



### Detailed technical data

#### Features

<b>Version</b>	Low Density
<b>Connection type</b>	Depending on the cloning plug used
<b>Reading field</b>	Front
<b>Sensor type</b>	Line scanner
<b>Optical focus</b>	Auto focus (alternative: dynamic focus control)
<b>No. of distance configurations</b>	≤ 8
<b>Focus adjustment time</b>	≤ 20 ms
<b>Focus trigger source</b>	Data interface
<b>Light source</b>	Light spot, laser, Visible, Red, 660 nm
<b>Laser class</b>	2 (IEC 60825-1:2014, EN 60825-1:2014)
<b>Aperture angle</b>	≤ 60°
<b>Reading distance</b>	500 mm ... 2,200 mm <sup>1)</sup>
<b>Scanning frequency</b>	400 Hz ... 1,200 Hz
<b>Code resolution</b>	0.35 mm ... 1.2 mm
<b>Heating</b>	✓
<b>Front screen heating</b>	✓
<b>Cold storage applications</b>	✓

<sup>1)</sup> For details see reading field diagram.

#### Mechanics/electronics

<b>Connection type</b>	Depending on the cloning plug used
<b>Supply voltage</b>	21.6 V DC ... 28.8 V DC
<b>Power consumption</b>	78 W
<b>Housing</b>	Aluminum die cast

<sup>1)</sup> At 25 °C.

<b>Housing color</b>	Light blue (RAL 5012)
<b>Window material</b>	Glass
<b>Enclosure rating</b>	IP65 (EN 60529/A1 (2002-02))
<b>Weight</b>	+ 1,500 g
<b>Dimensions (L x W x H)</b>	117 mm x 117 mm x 94 mm
<b>MTBF</b>	100,000 h
<b>MTTF</b>	40,000 h (Laser diode) <sup>1)</sup>

<sup>1)</sup> At 25 °C.

## Performance

<b>Readable code structures</b>	1D codes
<b>Bar code types</b>	Interleaved 2 of 5
<b>Code printing process</b>	Label (printed codes)
<b>Print ratio</b>	2:1 ... 3:1
<b>No. of codes per scan</b>	1 ... 20 (Standard decoder) 1 ... 6 (SMART decoder)
<b>No. of codes per reading interval</b>	1 ... 50 (auto-discriminating)
<b>No. of characters per reading interval</b>	5,000
<b>No. of multiple readings</b>	1 ... 100

## Interfaces

<b>Ethernet</b>	✓, TCP/IP, RS-232, RS-422, RS-485
Type of fieldbus integration	Optional over external fieldbus module CDF600-2 Optional over external fieldbus module CDF600-2
Remark	Only with cloning plug I/O, CAN IN/OUT or CAN Redundant
Function	Data interface (read result output), Service interface PROFINET Single Port, PROFINET Dual Port Data interface (read result output), AUX (only RS-232) SICK CAN sensor network CSN (CAN controller/CAN device, multiplexer/server)
Data transmission rate	10/100 MBit/s 10/100 MBit/s 0.3 kBaud ... 115.2 kBaud, AUX: 57.6 kBaud (RS-232) 20 kbit/s ... 1 Mbit/s
<b>Digital inputs</b>	6 ("Sensor 1" ... "Sensor 6")
<b>Digital outputs</b>	4 ("Result 1" ... "Result 4")
<b>Reading pulse</b>	Digital inputs
<b>Optical indicators</b>	6 LEDs (Ready, Result, laser, Data, CAN, LNK TX, Bar graph for displaying the reading rate percentage (10 LEDs))
<b>Control elements</b>	2 buttons
<b>Parameter storage</b>	Integrated in cloning plug
<b>Configuration software</b>	SOPAS ET

## Ambient data

<b>Electromagnetic compatibility (EMC)</b>	EN 61000-6-4 (2007-01) + A1 (2011), EN 61000-6-2:2005-08
<b>Vibration resistance</b>	EN 60068-2-6:2008-02
<b>Shock resistance</b>	EN 60068-2-27:2009-05
<b>Ambient operating temperature</b>	-35 °C ... +35 °C

<b>Storage temperature</b>	-20 °C ... +70 °C
<b>Permissible relative humidity</b>	90 %, Non-condensing
<b>Ambient light immunity</b>	2,000 lx, on barcode
<b>Bar code print contrast (PCS)</b>	≥ 60 %

### Classifications

<b>ECLASS 5.0</b>	27280102
<b>ECLASS 5.1.4</b>	27280102
<b>ECLASS 6.0</b>	27280102
<b>ECLASS 6.2</b>	27280102
<b>ECLASS 7.0</b>	27280102
<b>ECLASS 8.0</b>	27280102
<b>ECLASS 8.1</b>	27280102
<b>ECLASS 9.0</b>	27280102
<b>ECLASS 10.0</b>	27280102
<b>ECLASS 11.0</b>	27280102
<b>ECLASS 12.0</b>	27280102
<b>ETIM 5.0</b>	EC002550
<b>ETIM 6.0</b>	EC002550
<b>ETIM 7.0</b>	EC002550
<b>ETIM 8.0</b>	EC002550
<b>UNSPSC 16.0901</b>	43211701

### Dimensional drawing (Dimensions in mm (inch))

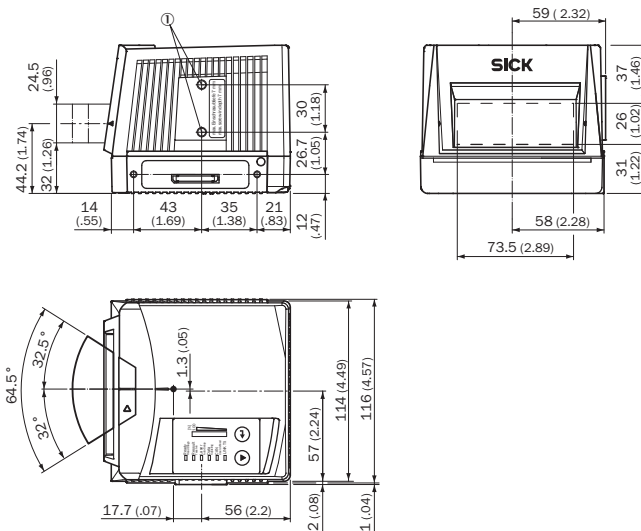

① M6 blind tapped holes, 7 mm deep (2 x), for mounting

## Reading field diagram

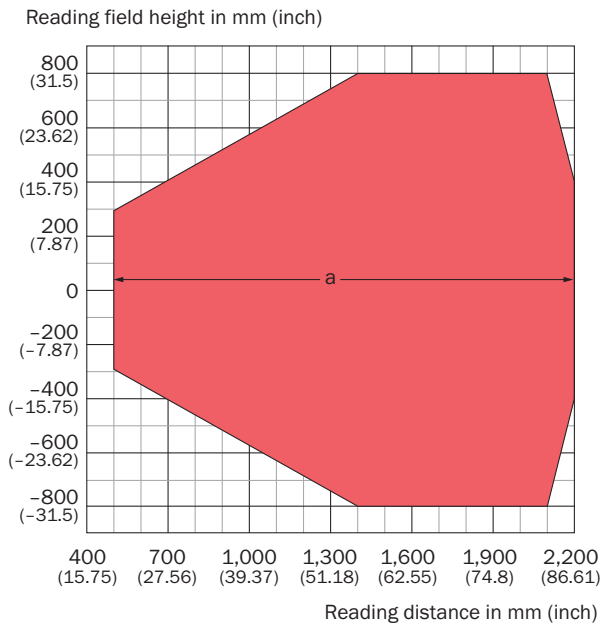





### Resolution





 a: 0.50 mm (19.7 mil)

Tilt  $\pm 15^\circ$ , typical specification

## Recommended accessories

Other models and accessories → [www.sick.com/CLV69x](http://www.sick.com/CLV69x)

	Brief description	Type	Part no.
<b>Cloning modules</b>			
	External parameter memory for integration in CDB620/CDB650/CDM42x	CMC600-101	1042259
<b>Mounting brackets and plates</b>			
	Mounting support with integrated vibration/shock absorption for suspended mounting (absorber elements above the CLV)	Mounting bracket with vibration/shock absorption for CLV69x	2088163
<b>Plug connectors and cables</b>			
	<ul style="list-style-type: none"> <li><b>Connection type head A:</b> Male connector, M12, 4-pin, straight, D-coded</li> <li><b>Connection type head B:</b> Male connector, RJ45, 8-pin, straight</li> <li><b>Signal type:</b> Ethernet</li> <li><b>Cable:</b> 2 m, 4-wire, AWG26</li> <li><b>Description:</b> Ethernet, shielded</li> </ul>	YM2D24-020EB2MRJA4	6050198
<b>Terminal and alignment brackets</b>			
	Quick-action lock system, mounting hardware included	Quick release	2016110

	Brief description	Type	Part no.
	<ul style="list-style-type: none"> <li><b>Connection type head A:</b> Male connector, male connector, female connector, M12, M12, M12, 17-pin, 5-pin, 4-pin</li> <li><b>Signal type:</b> Power, Ethernet, serial, CAN, digital I/Os</li> <li><b>Description:</b> Power, Ethernet, serial, CAN, digital I/Os, Required for connecting the CLV69x to the CDM420-006/7/8, CDB650, and CDF600-2</li> <li><b>Note:</b> Plug housing I/O, Ethernet</li> <li><b>Items supplied:</b> With three M12 round connectors (17-pin male connector, 4-pin Ethernet female connector, 5-pin CAN male connector)</li> </ul>	Cloning plug	2062452
	<ul style="list-style-type: none"> <li><b>Connection type head A:</b> Female connector, M12, 17-pin, straight, A-coded</li> <li><b>Connection type head B:</b> Male connector, M12, 17-pin, straight, A-coded</li> <li><b>Signal type:</b> Power, serial, CAN, digital I/Os</li> <li><b>Cable:</b> 2 m, suitable for refrigeration</li> <li><b>Description:</b> Power, serial, CAN, digital I/Os, suitable for 2 A, shielded</li> </ul>	YM2A8D-020XXXF2A8D	6053230
	<ul style="list-style-type: none"> <li><b>Connection type head A:</b> Female connector, M12, 5-pin, straight</li> <li><b>Connection type head B:</b> Flying leads</li> <li><b>Signal type:</b> Power</li> <li><b>Cable:</b> 5 m, 3-wire</li> <li><b>Description:</b> Power, shielded</li> <li><b>Application:</b> Cold bending resistant</li> </ul>	YFXXX-050XXX2Z1X	6053224
<b>Modules</b>			
	<ul style="list-style-type: none"> <li><b>Sub product family:</b> CDB650</li> <li><b>Supported products:</b> Lector® series, CLV62x - CLV64x (depending on type), CLV69x, RFID read/write device, InspectorP series</li> <li><b>Brief description:</b> Connection device basic for connecting one sensor with 2 A fuse, 5 cable glands and RS-232 interface to sensor via M12, 17-pin female connector, all outputs available on screw/spring-loaded terminals.</li> </ul>	CDB650-204	1064114

### Recommended services

Additional services → [www.sick.com/CLV69x](http://www.sick.com/CLV69x)

	Type	Part no.
<b>Performance check</b>		
<ul style="list-style-type: none"> <li><b>Product area:</b> Fixed mount barcode scanners</li> <li><b>Range of services:</b> Inspection of defined functions, e.g., reading performance</li> <li><b>Travel expenses:</b> The prices do not include travel costs such as hotel, flight, travel time and expenses.</li> <li><b>Duration:</b> Additional work will be invoiced separately</li> </ul>	Performance check CLV4xx/CLV6xx	1682028
<b>Commissioning</b>		
<ul style="list-style-type: none"> <li><b>Product area:</b> Fixed mount barcode scanners</li> <li><b>Range of services:</b> Inspection of connection, fine adjustment, optimization of parameters of SICK product as well as tests, Setup of previously defined functions of reading configuration, code configuration, data processing and network, interfaces or inputs and outputs</li> <li><b>Travel expenses:</b> The prices do not include travel costs such as hotel, flight, travel time and expenses.</li> <li><b>Duration:</b> Additional work will be invoiced separately</li> </ul>	Commissioning CLV65x ... CLV69x	1681926

	Type	Part no.
Service agreements		
<ul style="list-style-type: none"> <li>• <b>Product area:</b> Robot guidance systems, Track and trace systems, Driver assistance systems, Object detection systems, Profiling systems, Gateway systems, Quality control systems</li> <li>• <b>Range of services:</b> Maintenance, Troubleshooting, extended warranty, 8/5 remote support, 8/5 help desk</li> <li>• <b>Duration:</b> Duration is arranged individually with the customer and defined in the contract</li> </ul>	Bronze service agreements for Systems	1616164
<ul style="list-style-type: none"> <li>• <b>Product area:</b> Fixed mount barcode scanners</li> <li>• <b>Range of services:</b> According to the scope defined in the contract, for example extended warranty, repair service, availability guarantee as well as spare parts provided periodically by SICK (bracket with shock absorber), Other possible contractual elements</li> <li>• <b>Duration:</b> 5 year duration from delivery date of the initial hardware</li> </ul>	Forklift Package CLV69x for 5 years	1614613
Extended warranty		
<ul style="list-style-type: none"> <li>• <b>Product area:</b> Identification solutions, machine vision, Detection and ranging solutions, safety camera sensors, Safety laser scanners, Safety radar sensors</li> <li>• <b>Range of services:</b> The services correspond to the scope of the statutory manufacturer warranty (SICK general terms of delivery).</li> <li>• <b>Duration:</b> Five-year warranty from delivery date.</li> </ul>	Extended warranty for a total of five years from delivery date	1680671

## SICK AT A GLANCE

SICK is one of the leading manufacturers of intelligent sensors and sensor solutions for industrial applications. A unique range of products and services creates the perfect basis for controlling processes securely and efficiently, protecting individuals from accidents and preventing damage to the environment.

We have extensive experience in a wide range of industries and understand their processes and requirements. With intelligent sensors, we can deliver exactly what our customers need. In application centers in Europe, Asia and North America, system solutions are tested and optimized in accordance with customer specifications. All this makes us a reliable supplier and development partner.

Comprehensive services complete our offering: SICK LifeTime Services provide support throughout the machine life cycle and ensure safety and productivity.

For us, that is “Sensor Intelligence.”

## WORLDWIDE PRESENCE:

Contacts and other locations –[www.sick.com](http://www.sick.com)