



AHM36A-S3QM014x12

AHS/AHM36

ABSOLUTE ENCODERS

SICK
Sensor Intelligence.



Illustration may differ



Ordering information

| Type | Part no. |
|-------------------|----------|
| AHM36A-S3QM014x12 | 1101549 |

Other models and accessories → www.sick.com/AHS_AHM36

Detailed technical data

Performance

| | |
|---|----------------------------------|
| Number of steps per revolution (max. resolution) | 16,384 (14 bit) |
| Number of revolutions | 4,096 (12 bit) |
| Max. resolution (number of steps per revolution x number of revolutions) | 14 bit x 12 bit (16,384 x 4,096) |
| Error limits G | 0.35° (at 20 °C) ¹⁾ |
| Repeatability standard deviation σ_r | 0.2° (at 20 °C) ²⁾ |

¹⁾ In accordance with DIN ISO 1319-1, position of the upper and lower error limit depends on the installation situation, specified value refers to a symmetrical position, i.e. deviation in upper and lower direction is the same.

²⁾ In accordance with DIN ISO 55350-13; 68.3% of the measured values are inside the specified area.

Interfaces

| | |
|---------------------------------------|---|
| Communication interface | IO-Link |
| Communication Interface detail | IO-Link V1.1 / COM3 (230,4 kBaud) |
| Initialization time | 2 s ¹⁾ |
| Cycle time | ≤ 3.2 ms |
| Smart Sensor | Efficient communication, Enhanced Sensing, diagnosis |
| Process data | Position, speed, electronic cams, limit values, linear position, linear speed, errors and warnings, switching signals on pin 2 |
| Parameterising data | Number of steps per revolution Number of revolutions PRESET Counting direction Sampling rate for speed calculation Unit for output of the speed value Round axis functionality Electronic cams(2 channels x 8 cams) Limit values Linear measuring length per 360° Pin 2 configuration |
| Available diagnostics data | Minimum and maximum temperature |

¹⁾ Valid positional data can be read once this time has elapsed.

| | |
|---|--|
| | Maximum speed Power-on counter Operating hours counter power-on/motion Counter of direction changes/number of movements cw/number of movements ccw Minimum and maximum operating voltage Distance covered |
| Status information | Via status LED |
| Switching input/Switching output | ✓ |
| Pin 2 input frequency | ≤ 100 Hz |
| Pin 2 output frequency | ≤ 100 Hz |

¹⁾ Valid positional data can be read once this time has elapsed.

Electrical data

| | |
|--|--|
| Connection type | Cable, 4-wire, universal, 5 m |
| Supply voltage | 18 ... 30 V |
| Power consumption | ≤ 1.5 W |
| Reverse polarity protection | ✓ |
| MTTFd: mean time to dangerous failure | 240 years (EN ISO 13849-1) ¹⁾ |

¹⁾ This product is a standard product and does not constitute a safety component as defined in the Machinery Directive. Calculation based on nominal load of components, average ambient temperature 40 °C, frequency of use 8760 h/a. All electronic failures are considered hazardous. For more information, see document no. 8015532.

Mechanical data

| | |
|---------------------------------------|-----------------------------------|
| Mechanical design | Solid shaft, face mount flange |
| Shaft diameter | 6 mm |
| Shaft length | 12 mm |
| Weight | 0.12 kg ¹⁾ |
| Shaft material | Stainless steel |
| Flange material | Aluminum |
| Housing material | Zinc |
| Start up torque | < 1 Ncm (+20 °C) |
| Operating torque | < 1 Ncm (+20 °C) |
| Permissible shaft loading | 40 N (radial) 20 N (axial) |
| Operating speed | ≤ 6,000 min ⁻¹ |
| Moment of inertia of the rotor | 2.5 gcm ² |
| Bearing lifetime | 3.6 x 10 ⁸ revolutions |
| Angular acceleration | ≤ 500,000 rad/s ² |

¹⁾ Based on devices with male connector.

Ambient data

| | |
|--------------------------------------|--|
| EMC | According to EN 61000-6-2, EN 61000-6-3 and EN 61131-9 |
| Enclosure rating | IP66 (IEC 60529) IP67 (IEC 60529) |
| Permissible relative humidity | 90 % (Condensation not permitted) |
| Operating temperature range | -40 °C ... +85 °C |
| Storage temperature range | -40 °C ... +100 °C, without package |

| | |
|--------------------------------|---|
| Resistance to shocks | 100 g, 6 ms (EN 60068-2-27) |
| Resistance to vibration | 20 g, 10 Hz ... 2,000 Hz (EN 60068-2-6) |

Classifications

| | |
|-----------------------|----------|
| ECLASS 5.0 | 27270502 |
| ECLASS 5.1.4 | 27270502 |
| ECLASS 6.0 | 27270590 |
| ECLASS 6.2 | 27270590 |
| ECLASS 7.0 | 27270502 |
| ECLASS 8.0 | 27270502 |
| ECLASS 8.1 | 27270502 |
| ECLASS 9.0 | 27270502 |
| ECLASS 10.0 | 27270502 |
| ECLASS 11.0 | 27270502 |
| ECLASS 12.0 | 27270502 |
| ETIM 5.0 | EC001486 |
| ETIM 6.0 | EC001486 |
| ETIM 7.0 | EC001486 |
| ETIM 8.0 | EC001486 |
| UNSPSC 16.0901 | 41112113 |

Dimensional drawing (Dimensions in mm (inch))

Solid shaft, face mount flange, cable

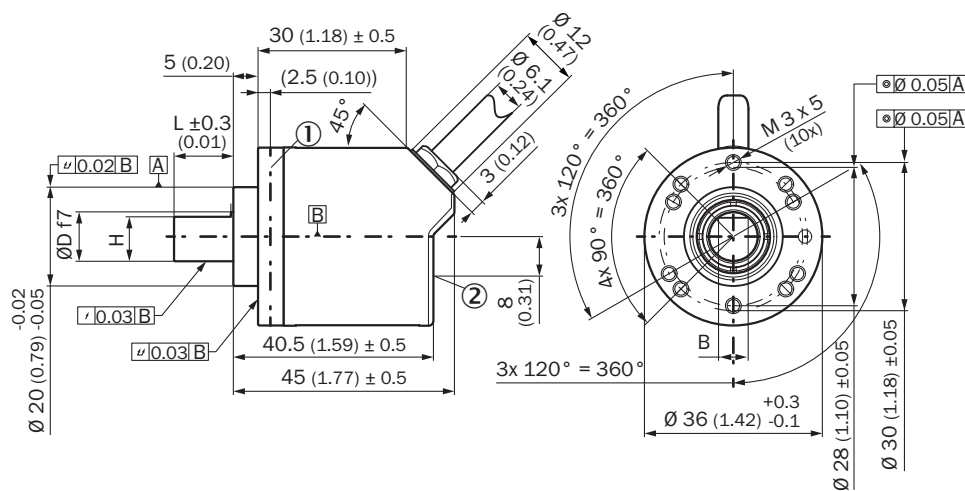

- ① Measuring point for operating temperature
- ② Measuring point for vibrations

| Type | Shaft diameter Ø D f7 | B | H |
|--------------------------------------|--------------------------|--------|--------|
| AHx36x-S1xxxxxxx AHx36x-S3xxxxxxx | 6 mm | 3,6 mm | 5,4 mm |
| AHx36x-S9xxxxxxx AHx36x-S5xxxxxxx | 8 mm | 3,9 mm | 7,5 mm |

| Type | Shaft diameter Ø D f7 | B | H |
|--|--------------------------|---------|--------|
| AHx36x-S2xxxxxxx AHx36x-S4xxxxxxx AHx36x-SCxxxxxxx | 10 mm | 6 mm | 9 mm |
| AHx36x-SAxxxxxxx AHx36x-S8xxxxxxx | 1/4" | 3,85 mm | 5,7 mm |
| AHx36x-SBxxxxxxx AHx36x-S7xxxxxxx | 3/8" | 4,35 mm | 9 mm |

Attachment specifications

Solid shaft, face mount flange with flange adapter, centering collar D20 on D50 (BEF-FA-020-050, 2072297)

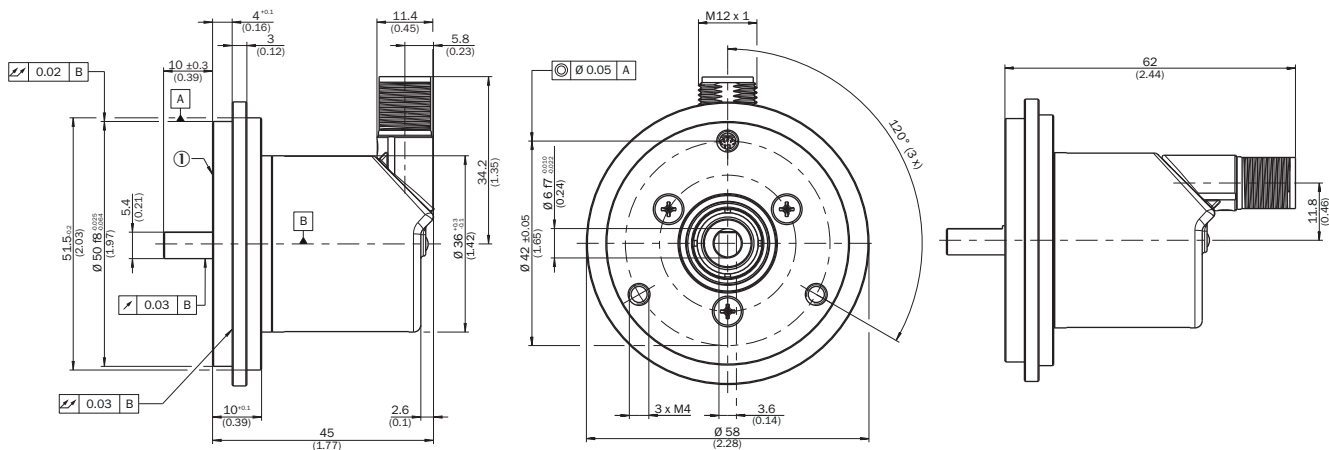

Order example for 6 mm shaft diameter: AHx36x-S3xx0xxxxx + BEF-FA-020-050 (adapter is not pre-assembled)

① Measuring point for operating temperature

Solid shaft, face mount flange with flange adapter, centering collar D20 on D36, 2 mm high (BEF-FA-020-036-002, 2072296)

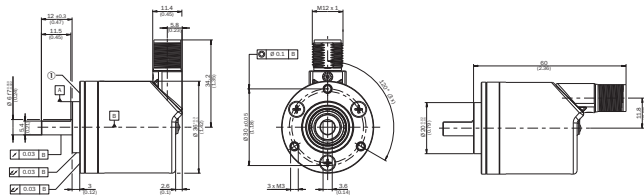

Order example for 6 mm shaft diameter: AHx36x-S3xx0xxxxx + BEF-FA-020-036-002 (adapter is not pre-assembled)

① Measuring point for operating temperature

Solid shaft, face mount flange with flange adapter, centering collar D20 on D24 (BEF-FA-020-024, 2072294)

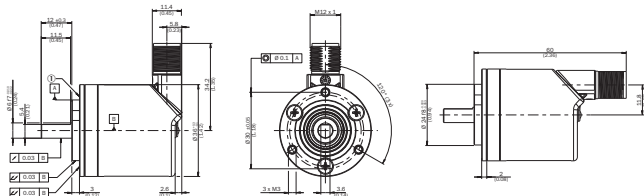

Order example for 6 mm shaft diameter: AHx36x-S3xx0xxxxx + BEF-FA-020-024 (adapter is not pre-assembled)

① Measuring point for operating temperature



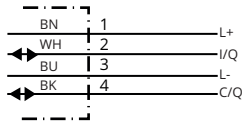











PIN assignment











| PIN | Wire color | Signal | Function | | |
|-----|------------|--------|--------------------------------------|---|-----------------------------|
| | | | Basic | Advanced | Advanced Smart Task |
| 1 | Brown | L+ | Encoder supply voltage 18-30 V (+Us) | | |
| 2 | White | I/Q | Not connected - no function | Multifunctional pin (configurable as switching input or switching output) | |
| 3 | Blue | L- | Encoder supply voltage 0 V (GND) | | |
| 4 | Black | C/Q | IO-Link communication | | Switching output (SIO mode) |

Recommended accessories

Other models and accessories → www.sick.com/AHS_AHM36

| | Brief description | Type | Part no. |
|---|---|--------------------|----------|
| Other mounting accessories | | | |
| | O-ring for measuring wheels (circumference 200 mm) | BEF-OR-053-040 | 2064061 |
| | O-ring for measuring wheels (circumference 300 mm), 2x O-ring | BEF-OR-083-050 | 2064076 |
| Plug connectors and cables | | | |
|  |  | DOS-1204-G | 6007302 |
| Shaft adaptation | | | |
|  |  | KUP-0606-B | 5312981 |
| | | KUP-0610-B | 5312982 |
|  |  | KUP-0610-D | 5326697 |
|  |  | KUP-0610-F | 5312985 |
|  |  | KUP-0610-J | 2127056 |
| Others | | | |
|  |  | YF2A14-020UB3M2A14 | 2096000 |
|  |  | YF2A14-050UB3M2A14 | 2096001 |

| | Brief description | Type | Part no. |
|---|---|--------------------|----------|
|  |  | YF2A14-100UB3M2A14 | 2096002 |
|  |  | YF2A14-020UB3XLEAX | 2095607 |
|  |  | YF2A14-050UB3XLEAX | 2095608 |
|  |  | YF2A14-100UB3XLEAX | 2095609 |

SICK AT A GLANCE

SICK is one of the leading manufacturers of intelligent sensors and sensor solutions for industrial applications. A unique range of products and services creates the perfect basis for controlling processes securely and efficiently, protecting individuals from accidents and preventing damage to the environment.

We have extensive experience in a wide range of industries and understand their processes and requirements. With intelligent sensors, we can deliver exactly what our customers need. In application centers in Europe, Asia and North America, system solutions are tested and optimized in accordance with customer specifications. All this makes us a reliable supplier and development partner.

Comprehensive services complete our offering: SICK LifeTime Services provide support throughout the machine life cycle and ensure safety and productivity.

For us, that is “Sensor Intelligence.”

WORLDWIDE PRESENCE:

Contacts and other locations –www.sick.com