



Product designation				Power contactor
Product type designation				BF18
Contact characteristics				
Number of poles	Nr.			4
Rated insulation voltage U _i IEC/EN	V			690
Rated impulse withstand voltage U _{imp}	kV			6
Operational frequency	min	Hz		25
	max	Hz		400
IEC Conventional free air thermal current I _{th}	A			32
Operational current I _e	AC-1 (≤40°C)	A		32
	AC-1 (≤55°C)	A		26
	AC-1 (≤70°C)	A		23
	AC-3 (≤440V ≤55°C)	A		18
	AC-4 (400V)	A		8.5
Rated operational power AC-1 (T≤40°C)	230V	kW		12
	400V	kW		21
	500V	kW		26
	690V	kW		36
Short-time allowable current for 10s (IEC/EN60947-1)	A			200
Protection fuse	gG (IEC)	A		32
	aM (IEC)	A		20
Making capacity (RMS value)	A			180
Breaking capacity at voltage	440V	A		144
	500V	A		120
	690V	A		94
Resistance per pole (average value)	mΩ			2.5
Power dissipation per pole (average value)	I _{th}	W		2.6
	AC-3	W		0.8
Tightening torque for terminals	min	Nm		1.5
	max	Nm		1.8
	min	lbin		1.1
	max	lbin		1.5
Tightening torque for coil terminal	min	Nm		0.8
	max	Nm		1
	min	lbin		0.8
	max	lbin		0.74
Max number of wires simultaneously connectable	Nr.			2

Conductor section	AWG/Kcmil			
		max		10
Flexible w/o lug conductor section		min	mm ²	1
		max	mm ²	6
Flexible c/w lug conductor section		min	mm ²	1
		max	mm ²	4
Flexible with insulated spade lug conductor section		min	mm ²	1
		max	mm ²	4

Power terminal protection according to IEC/EN 60529 IP20 when properly wired

Mechanical features

Operating position	normal allowable	Vertical plan ±30°
Fixing		Screw / DIN rail 35mm
Weight		g 1400

Conductor section	AWG/kcmil conductor section	max	10
-------------------	-----------------------------	-----	----

Operations

Mechanical life	cycles	20000000
Electrical life	cycles	1600000

Safety related data

Performance level B10d according to EN/ISO 13489-1	rated load mechanical load	cycles	1600000
		cycles	20000000
Mirror contacts according to IEC/EN 60947-4-1			YES
EMC compatibility			yes

AC coil operating

Rated AC voltage at 60Hz	V	460
AC operating voltage		
of 60Hz coil powered at 60Hz		
pick-up	min %Us	80
	max %Us	110
drop-out	min %Us	20
	max %Us	55

AC average coil consumption at 20°C			
of 60Hz coil powered at 60Hz			
	in-rush holding	VA	75
		VA	9
Dissipation at holding ≤20°C 50Hz		W	2.5

Max cycles frequency

Mechanical operation cycles/h 3600

Operating times

Average time for Us control in AC

Closing NO	min	ms	8
	max	ms	24
Opening NO	min	ms	10
	max	ms	20
Closing NC	min	ms	14
	max	ms	28
Opening NC	min	ms	7
	max	ms	18

UL technical data

Full-load current (FLA) for three-phase AC motor

at 480V	A	14
at 600V	A	17

Yielded mechanical performance

for single-phase AC motor

110/120V	HP	1
230V	HP	3

for three-phase AC motor

200/208V	HP	5
220/230V	HP	5
460/480V	HP	10
575/600V	HP	15

General USE

Contactor

AC current	A	32
------------	---	----

Ambient conditions

Temperature

Operating temperature

min	°C	-50
max	°C	70

Storage temperature

min	°C	-60
max	°C	80

Max altitude

m	3000
---	------

Resistance & Protection

Pollution degree

3

Dimensions

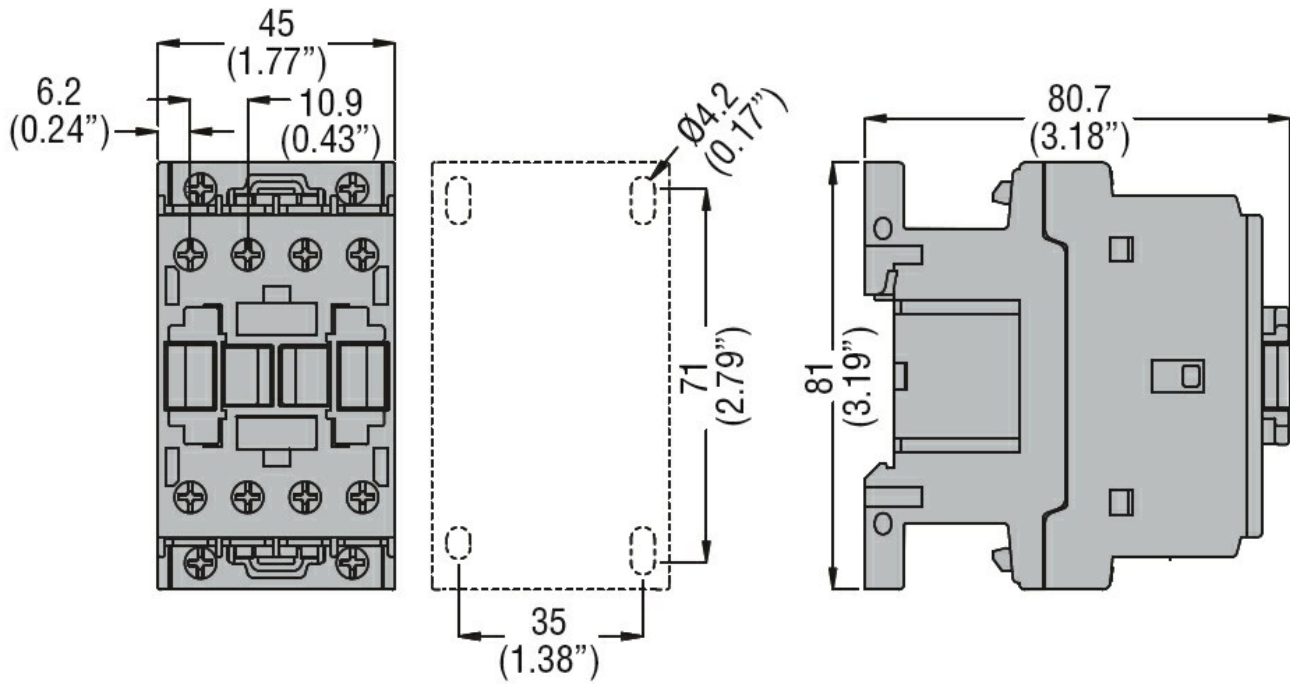

Wiring diagrams

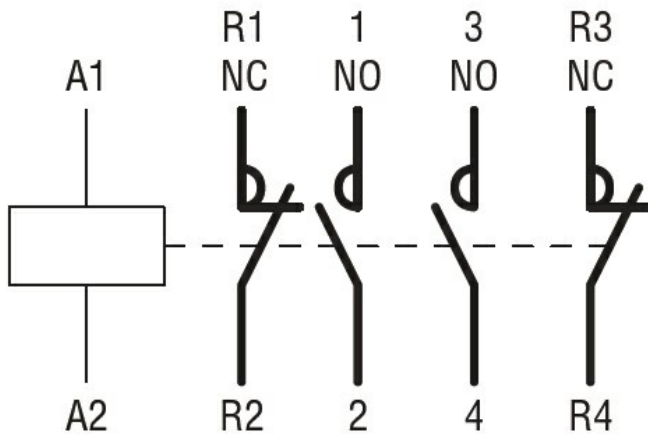

Certifications and compliance

Compliance

CSA C22.2 n° 60947-1
CSA C22.2 n° 60947-4-1
IEC/EN/BS 60947-1
IEC/EN/BS 60947-4-1
UL 60947-1
UL 60947-4-1

Certificates

CCC
cULus
EAC

ETIM classification

ETIM 8.0

EC000066 -
Power contactor,
AC switching