



AFS60A-S4AA262144

AFS/AFM60 SSI

ABSOLUTE ENCODERS

SICK
Sensor Intelligence.

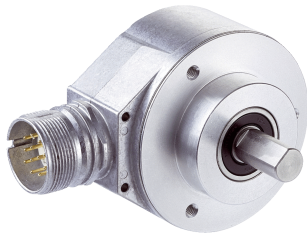

Ordering information

Type	Part no.
AFS60A-S4AA262144	1037441

Other models and accessories → www.sick.com/AFS_AFM60_SSI

Illustration may differ



Detailed technical data

Performance

Number of steps per revolution (max. resolution)	262,144 (18 bit)
Error limits G	0.03° ¹⁾
Repeatability standard deviation σ_r	0.002° ²⁾

¹⁾ In accordance with DIN ISO 1319-1, position of the upper and lower error limit depends on the installation situation, specified value refers to a symmetrical position, i.e. deviation in upper and lower direction is the same.

²⁾ In accordance with DIN ISO 55350-13; 68.3% of the measured values are inside the specified area.

Interfaces

Communication interface	SSI
Initialization time	50 ms ¹⁾
Position forming time	< 1 μ s
Code type	Gray
Code sequence parameter adjustable	CW/CCW (V/R) parameter adjustable
Clock frequency	\leq 2 MHz ²⁾
Set (electronic adjustment)	H-active (L = 0 - 3 V, H = 4,0 - U _s V)
CW/CCW (counting sequence when turning)	L-active (L = 0 - 1,5 V, H = 2,0 - U _s V)

¹⁾ Valid positional data can be read once this time has elapsed.

²⁾ Minimum, LOW level (Clock +): 250 ns.

Electrical data

Connection type	Male connector, M23, 12-pin, radial
Supply voltage	4.5 ... 32 V
Power consumption	\leq 0.7 W (without load)
Reverse polarity protection	✓
MTTF: mean time to dangerous failure	250 years (EN ISO 13849-1) ¹⁾

¹⁾ This product is a standard product and does not constitute a safety component as defined in the Machinery Directive. Calculation based on nominal load of components, average ambient temperature 40 °C, frequency of use 8760 h/a. All electronic failures are considered hazardous. For more information, see document no. 8015532.

Mechanical data

Mechanical design	Solid shaft, face mount flange
Shaft diameter	10 mm
Shaft length	19 mm
Weight	0.3 kg ¹⁾
Shaft material	Stainless steel
Flange material	Aluminum
Housing material	Aluminum die cast
Start up torque	< 0.5 Ncm (+20 °C)
Operating torque	< 0.3 Ncm (+20 °C)
Permissible shaft loading	80 N (radial) 40 N (axial)
Operating speed	≤ 9,000 min ⁻¹ 2)
Moment of inertia of the rotor	6.2 gcm ²
Bearing lifetime	3.0 x 10 ⁹ revolutions
Angular acceleration	≤ 500,000 rad/s ²

¹⁾ Based on devices with male connector.

²⁾ Allow for self-heating of 3.3 K per 1,000 rpm when designing the operating temperature range.

Ambient data

EMC	According to EN 61000-6-2 and EN 61000-6-3 ¹⁾
Enclosure rating	IP65, shaft side (IEC 60529) IP67, housing side (IEC 60529) ²⁾
Permissible relative humidity	90 % (Condensation not permitted)
Operating temperature range	-40 °C ... +100 °C ³⁾
Storage temperature range	-40 °C ... +100 °C, without package
Resistance to shocks	60 g, 6 ms (EN 60068-2-27)
Resistance to vibration	20 g, 10 Hz ... 2,000 Hz (EN 60068-2-6)

¹⁾ EMC according to the standards quoted is achieved if shielded cables are used.

²⁾ For devices with male connector: with mounted mating connector.

³⁾ Stationary position of the cable.

Classifications

eCl@ss 5.0	27270502
eCl@ss 5.1.4	27270502
eCl@ss 6.0	27270590
eCl@ss 6.2	27270590
eCl@ss 7.0	27270502
eCl@ss 8.0	27270502
eCl@ss 8.1	27270502
eCl@ss 9.0	27270502
eCl@ss 10.0	27270502
eCl@ss 11.0	27270502
eCl@ss 12.0	27270502

ETIM 5.0	EC001486
ETIM 6.0	EC001486
ETIM 7.0	EC001486
ETIM 8.0	EC001486
UNSPSC 16.0901	41112113

Dimensional drawing (Dimensions in mm (inch))

Face mount flange, M12 and M23 radial male connector

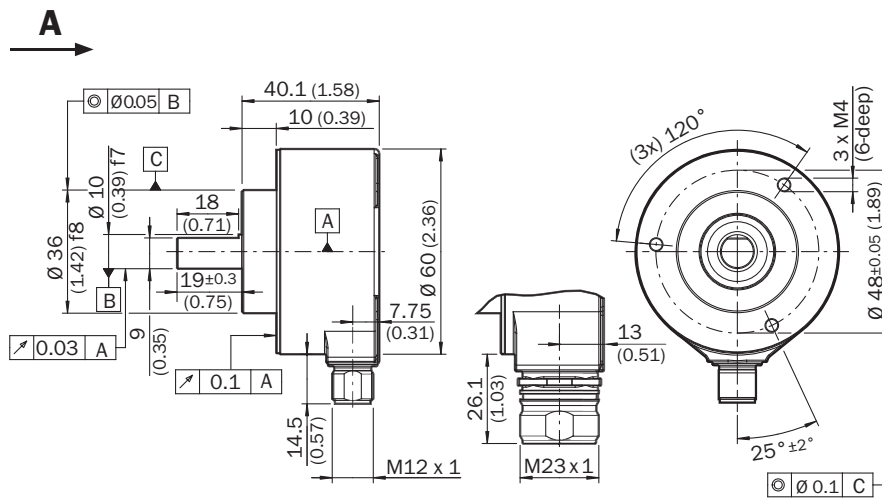

General tolerances according to DIN ISO 2768-mk

PIN assignment

M23 male connector, 12-pin, SSI/Gray

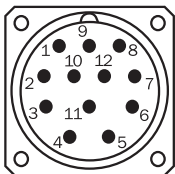

View of M23 male device connector on encoder

PIN	Signal	Explanation
1	GND	Ground connection
2	Data +	Interface signals
3	Clock +	Interface signals
4	N.C.	Not assigned
5	N.C.	Not assigned
6	N.C.	Not assigned
7	N.C.	Not assigned
8	U _s	Operating voltage

PIN	Signal	Explanation
9	SET	Electronic adjustment
10	Data -	Interface signals
11	Clock -	Interface signals
12	V/R	Sequence in direction of rotation
	Screen	Screen connected to housing on encoder side. Connected to ground on control side.



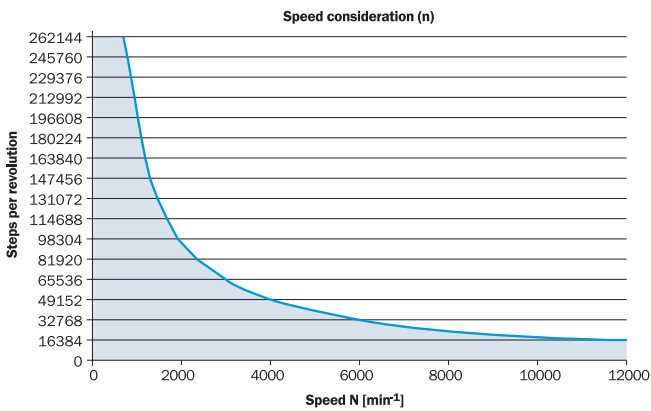

Diagrams















The maximum speed is also dependent on the shaft type.

Recommended accessories

Other models and accessories → www.sick.com/AFS_AFM60_SSI

	Brief description	Type	Part no.
Flanges			
	Flange adapter, adaptation of face mount flange with 36 mm centering hub to 100 mm servo flange with 60 mm centering hub, aluminum, Aluminum	BEF-FA-036-100	2029161
Other mounting accessories			
	Servo clamps, large, for servo flange (clamps, eccentric fastener), 3 pcs, without mounting material, without mounting hardware	BEF-WK-SF	2029166
Plug connectors and cables			
	Head A: cable Head B: Flying leads Cable: SSI, Incremental, HIPERFACE®, PUR, halogen-free, shielded	LTG-2308-MWENC	6027529
	Head A: female connector, M23, 12-pin, straight Head B: Flying leads Cable: SSI, PUR, halogen-free, shielded, 3 m	DOL-2308-G03MAA6	2048597
	Head A: female connector, M23, 12-pin, straight Head B: Flying leads Cable: SSI, PUR, halogen-free, shielded, 5 m	DOL-2308-G05MAA6	2048598

	Brief description	Type	Part no.
	Head A: female connector, M23, 12-pin, straight Head B: Flying leads Cable: SSI, PUR, halogen-free, shielded, 0.5 m	DOL-2308-G0M5AA6	2048595
	Head A: female connector, M23, 12-pin, straight Head B: Flying leads Cable: SSI, PUR, halogen-free, shielded, 10 m	DOL-2308-G10MAA6	2048599
	Head A: female connector, M23, 12-pin, straight Head B: Flying leads Cable: SSI, PUR, halogen-free, shielded, 1.5 m	DOL-2308-G1M5AA6	2048596
	Head A: female connector, M23, 9-pin, straight Cable: HIPERFACE®, SSI, Incremental, shielded	DOS-2309-G	6028533
	Head A: female connector, M23, 12-pin, straight Cable: HIPERFACE®, SSI, Incremental, shielded	DOS-2312-G	6027538
		DOS-2312-G02	2077057
	Head A: female connector, M23, 12-pin, angled Cable: HIPERFACE®, SSI, Incremental, shielded	DOS-2312-W01	2072580
Shaft adaptation			
	Bellows coupling, shaft diameter 6 mm / 10 mm, maximum shaft offset: radial ± 0.25 mm, axial ± 0.4 mm, angular $\pm 4^\circ$; max. speed 10,000 rpm, -30°C to $+120^\circ\text{C}$, max. torque 120 Ncm; material: stainless steel bellows, aluminum hub	KUP-0610-B	5312982
	Double loop coupling, shaft diameter 6 mm / 10 mm, max. shaft offset: radially ± 2.5 mm, axially ± 3 mm, angle ± 10 degrees; max. speed 3,000 rpm, -30 to $+80$ degrees Celsius, torsional spring stiffness of 25 Nm/rad	KUP-0610-D	5326697
	Spring washer coupling, shaft diameter 6 mm / 10 mm, Maximum shaft offset: radial ± 0.3 mm, axial ± 0.4 mm, angular $\pm 2.5^\circ$; max. speed 12,000 rpm, -10° to $+80^\circ\text{C}$, max. torque 60 Ncm; material: aluminum flange, glass fiber-reinforced polyamide membrane and hardened steel coupling pin	KUP-0610-F	5312985
	Claw coupling, shaft diameter 6 mm / 10 mm, damping element 80 shore blue, maximum shaft offset: radial ± 0.22 mm, axial ± 1 mm angular $\pm 1.3^\circ$, max. speed 19,000 rpm, angle of twist max. 10° , -30°C to $+80^\circ\text{C}$, max. torque 800 Ncm, tightening torque of screws: ISO 4029 150 Ncm, material: aluminum flange, damping element: polyurethane	KUP-0610-J	2127056
	Bar coupling, shaft diameter 6 mm / 10 mm, max. shaft offset: radial ± 0.3 mm, axial ± 0.3 mm, angular $\pm 3^\circ$; max. speed 10,000 rpm, -10° to $+80^\circ\text{C}$, max. torque: 80 Ncm, material: fiber-glass reinforced polyamide, aluminum hub	KUP-0610-S	2056407
	Double loop coupling, shaft diameter 8 mm / 10 mm, max. shaft offset: radially ± 0.25 mm, axially ± 0.4 mm, angle ± 4 degrees; max. speed 10,000 rpm, -30 to $+120$ degrees Celsius, torsional spring stiffness of 150 Nm/rad	KUP-0810-D	5326704
	Claw coupling, shaft diameter 8 mm / 10 mm, damping element 80 shore blue, maximum shaft offset: radial ± 0.22 mm, axial ± 1 mm angular $\pm 1.3^\circ$, max. speed 19,000 rpm, angle of twist max. 10° , -30°C to $+80^\circ\text{C}$, max. torque 800 Ncm, tightening torque of screws: ISO 4029 150 Ncm, material: aluminum flange, damping element: polyurethane	KUP-0810-J	2128267
	Bar coupling, shaft diameter 8 mm / 10 mm, max. shaft offset: radial ± 0.3 mm, axial ± 0.3 mm, angular $\pm 3^\circ$; max. speed 10,000 rpm, -10° to $+80^\circ\text{C}$, max. torque: 80 Ncm, material: fiber-glass reinforced polyamide, aluminum hub	KUP-0810-S	5314178
	Bellows coupling, shaft diameter 10 mm/10 mm; maximum shaft offset: radial ± 0.25 mm, axial ± 0.4 mm, angular $\pm 4^\circ$; max. revolutions 10,000 rpm, -30° to $+120^\circ\text{C}$, max. torque 120 Ncm; material: stainless steel bellows, aluminum clamping hubs	KUP-1010-B	5312983
	Double loop coupling, shaft diameter 10 mm / 10 mm, Maximum shaft offset: radial ± 2.5 mm, axial ± 3 mm, angular $\pm 10^\circ$; max. speed 3,000 rpm, -30° to $+80^\circ\text{C}$, max. torque 1.5 Nm; material: polyurethane, galvanized steel flange	KUP-1010-D	5326703

	Brief description	Type	Part no.
	Spring washer coupling, shaft diameter 10 mm / 10 mm, maximum shaft offset, radial ± 0.3 mm, axial ± 0.4 mm, angle $\pm 2.5^\circ$, torsion spring stiffness 30 Nm/rad; material: aluminum flange, glass-fiber reinforced polyamide membrane and hardened steel coupling pin	KUP-1010-F	5312986
	Claw coupling, shaft diameter 10 mm / 10 mm, damping element 80 shore blue, maximum shaft offset: radial ± 0.22 mm, axial ± 1 mm angular $\pm 1.3^\circ$, max. speed 19,000 rpm, angle of twist max. 10° , -30°C to $+80^\circ\text{C}$, max. torque 800 Ncm, tightening torque of screws: ISO 4029 150 Ncm, material: aluminum flange, damping element: polyurethane	KUP-1010-J	2127054
	Bar coupling, shaft diameter 10 mm / 10 mm; maximum shaft offset: radial ± 0.3 mm, axial ± 0.2 mm, angular $\pm 3^\circ$; speed 10,000 rpm, -10° to $+80^\circ$ Celsius, max. torque 80 Ncm; material: glass fiber-reinforced polyamide, aluminum hub	KUP-1010-S	2056408
	Spring washer coupling, shaft diameter 10 mm / 10 mm, maximum shaft offset, radial ± 1.5 mm, axial ± 1.0 mm, angle $\pm 5^\circ$, torsion spring stiffness 30 Nm/rad; material: aluminum flange, glass-fiber reinforced polyamide membrane and hardened steel coupling pin	KUP-1010-W	5319914
	10 mm / 12 mm; maximum shaft offset: radial ± 0.25 mm, axial ± 0.4 mm, angular $\pm 4^\circ$; max. revolutions 10,000 rpm, -30° to $+120^\circ\text{C}$, max. torque 120 Ncm; material: stainless steel bellows, aluminum clamping hubs	KUP-1012-B	5312984
	Double loop coupling, shaft diameter 10 mm / 12 mm, Maximum shaft offset: radial ± 2.5 mm, axial ± 3 mm, angular $\pm 10^\circ$; max. speed 3,000 rpm, -30° to $+80^\circ\text{C}$, max. torque 1.5 Nm; material: polyurethane, galvanized steel flange	KUP-1012-D	5326702
	Claw coupling, shaft diameter 10 mm / 12 mm, damping element 80 shore blue, maximum shaft offset: radial ± 0.22 mm, axial ± 1 mm angular $\pm 1.3^\circ$, max. speed 19,000 rpm, angle of twist max. 10° , -30°C to $+80^\circ\text{C}$, max. torque 800 Ncm, tightening torque of screws: ISO 4029 150 Ncm, material: aluminum flange, damping element: polyurethane	KUP-1012-J	2128265

SICK AT A GLANCE

SICK is one of the leading manufacturers of intelligent sensors and sensor solutions for industrial applications. A unique range of products and services creates the perfect basis for controlling processes securely and efficiently, protecting individuals from accidents and preventing damage to the environment.

We have extensive experience in a wide range of industries and understand their processes and requirements. With intelligent sensors, we can deliver exactly what our customers need. In application centers in Europe, Asia and North America, system solutions are tested and optimized in accordance with customer specifications. All this makes us a reliable supplier and development partner.

Comprehensive services complete our offering: SICK LifeTime Services provide support throughout the machine life cycle and ensure safety and productivity.

For us, that is “Sensor Intelligence.”

WORLDWIDE PRESENCE:

Contacts and other locations –www.sick.com