

Product designation				Rotary cam switches
Product type designation				GN315
<b>General characteristics</b>				
Switching diagram				07 - ON/OFF switch 3 poles
N° of elements				2
Mounting form				U - Front mounting with black handle
<b>Contact characteristics</b>				
Rated insulation voltage $U_i$	IEC/EN	V	690	
	UL/CSA	V	600	
Rated impulse withstand voltage $U_{imp}$		kV	8	
Conventional free air thermal current $I_{th}$	IEC/EN	A	315	
	UL/CSA	A	255	
Rated operational voltage		V	690	
Rated operational impulse voltage		kV	6	
Maximum fuse size for short-circuit protection $I_n$ (gG)	10kA	A	315	
	15kA	A	315	
Rated short time current $I_{cw}$	1s	A	5200	
Operational current $I_e$ IEC/EN AC1/AC21A		A	315	
Rated operational power in AC Three-phase AC-3	220/230V	kW	37	
	380/440V	kW	55	
	500/690V	kW	69	
Single-phase AC-3	110V	kW	11	
	220/230V	kW	22	
	380/440V	kW	30	
Rated operational current in DC DC21A	48V	A	200	
	60V	A	200	
	110V	A	35	
	220V	A	2.5	
	440V	A	0.9	
Power dissipation		W	64.5	
<b>Mechanical features</b>				
Terminals screw				M10
Tightening torque for terminals max				Nm 10
Conductor size	AWG - Rigid cable			
	Max	AWG	1XMCM350	
	AWG - Flexible cable			
	Max	AWG	1XMCM350	

Conductor size (IEC) - Flexible cable	Max	mm <sup>2</sup>	1X185
---------------------------------------	-----	-----------------	-------

Conductor size (IEC) - Rigid cable	Max	mm <sup>2</sup>	1X185
------------------------------------	-----	-----------------	-------

Mechanical life		cycles	2X10 <sup>5</sup>
-----------------	--	--------	-------------------

**UL technical data**

Motor power for direct-on-line control for three-phase motor	120V	HP	30
	240V	HP	50
	480V	HP	100
	600V	HP	75

for single-phase motor	120V	HP	15
	240V	HP	30

**Ambient conditions**

Temperature

Operating temperature	min	°C	-25
	max	°C	+55

Storage temperature	min	°C	-40
	max	°C	+70

**Resistance & Protection**

Frontal IP degree	IP40
-------------------	------

Terminals IP degree	IP00
---------------------	------

**Dimensions**

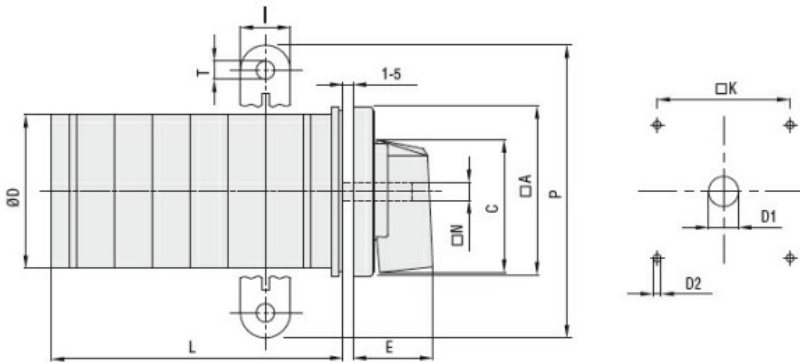

Series	Dimensions											L Number of elements ①											
	□A	C	ØD	ØD1	ØD2	E	I	□K	□N	P	ØT	1	2	3	4	5	6	7	8	9	10	11	12
GN200	132	104	120	16	5.3	56	20	104	10	140	10.5	77	107	136	166	196	226	284	314	343	373	402	432
GN315	132	104	120	16	5.3	56	20	104	10	145	10.5	77	107	136	166	196	226	284	314	343	373	402	432

① For devices with 6 or more elements please consult Technical support, see contact details on inside front cover.

**Wiring diagrams**

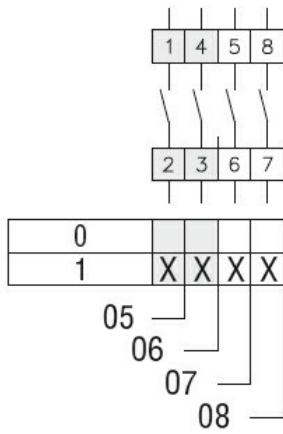

### Certifications and compliance

#### Compliance

IEC/EN/BS 60947-1  
IEC/EN/BS 60947-3  
IEC/EN/BS 60947-5-1  
UL60947-4-1

#### Certificates

UR

### ETIM classification

ETIM 8.0

EC001029 -  
Selector switch,  
complete