



BEF-KHZR085MPA

SICK
Sensor Intelligence.



Ordering information

Type	Part no.
BEF-KHZR085MPA	2066626

Other models and accessories → www.sick.com/

Detailed technical data

Technical specifications

Accessory group	Brackets for cylinder sensors
Accessory family	For round body cylinders
Material	Stainless steel V2A
Description	For round body cylinders with diameter up to 85 mm
Usable for	MPA-107 mm ... 359 mm (measuring range sensor), 2 (recommended number brackets) MPA-395 mm ... 647 mm (measuring range sensor), 3 (recommended number brackets) MPA-683 mm ... 935 mm (measuring range sensor), 4 (recommended number brackets) MPA-971 mm ... 1,007 mm (measuring range sensor), 5 (recommended number brackets)

Classifications

eCl@ss 5.0	27279202
eCl@ss 5.1.4	27279202
eCl@ss 6.0	27279202
eCl@ss 6.2	27279202
eCl@ss 7.0	27279202
eCl@ss 8.0	27279202
eCl@ss 8.1	27279202
eCl@ss 9.0	27273701
eCl@ss 10.0	27273701
eCl@ss 11.0	27273701
eCl@ss 12.0	27273701
ETIM 5.0	EC002024
ETIM 6.0	EC002024
ETIM 7.0	EC002024
ETIM 8.0	EC002024
UNSPSC 16.0901	32131023

Dimensional drawing (Dimensions in mm (inch))

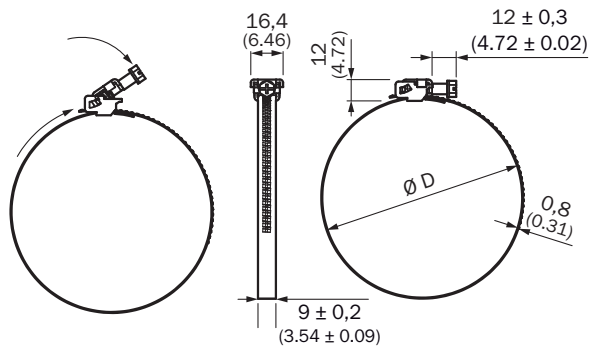

Diameter
(D) mm

BEF-KHZR085MPA	25 - 100
BEF-KHZR135MPA	25 - 150
BEF-KHZR210MPA	25 - 225

SICK AT A GLANCE

SICK is one of the leading manufacturers of intelligent sensors and sensor solutions for industrial applications. A unique range of products and services creates the perfect basis for controlling processes securely and efficiently, protecting individuals from accidents and preventing damage to the environment.

We have extensive experience in a wide range of industries and understand their processes and requirements. With intelligent sensors, we can deliver exactly what our customers need. In application centers in Europe, Asia and North America, system solutions are tested and optimized in accordance with customer specifications. All this makes us a reliable supplier and development partner.

Comprehensive services complete our offering: SICK LifeTime Services provide support throughout the machine life cycle and ensure safety and productivity.

For us, that is “Sensor Intelligence.”

WORLDWIDE PRESENCE:

Contacts and other locations –www.sick.com