



WTT12LC-B1563

PowerProx

MULTITASK PHOTOELECTRIC SENSORS

SICK
Sensor Intelligence.



Illustration may differ



Ordering information

Type	Part no.
WTT12LC-B1563	1103602

Other models and accessories → www.sick.com/PowerProx

Detailed technical data

Features

Functional principle	Photoelectric proximity sensor
Functional principle detail	Background suppression, Optical time-of-flight
Dimensions (W x H x D)	20 mm x 49.6 mm x 44.2 mm
Housing design (light emission)	Rectangular
Sensing range max.	50 mm ... 3,800 mm ¹⁾
Sensing range	100 mm ... 3,800 mm ^{1) 2)}
Distance value	
Measuring range	50 mm ... 3,800 mm ¹⁾
Resolution	1 mm
Repeatability	1,1 mm ... 3,0 mm ^{3) 4) 5)}
Accuracy	Typ. ± 15 mm
Type of light	Visible red light
Light source	Laser ⁶⁾
Light spot size (distance)	Ø 18 mm (3,800 mm)
Wave length	658 nm
Laser class	1 (IEC 60825-1 / CDRH 21 CFR 1040.10 & 1040.11)
Adjustment	Single teach-in button (2 x)

¹⁾ Object with 6 ... 90% remission (based on standard white, DIN 5033).

²⁾ Adjustable.

³⁾ Equivalent to 1 σ .

⁴⁾ See characteristic curves repeatability.

⁵⁾ 6% ... 90% remission factor.

⁶⁾ Average service life: 100,000 h at T_U = +25 °C.

IO-Link

- 1) Object with 6 ... 90% remission (based on standard white, DIN 5033).
- 2) Adjustable.
- 3) Equivalent to 1 σ .
- 4) See characteristic curves repeatability.
- 5) 6% ... 90% remission factor.
- 6) Average service life: 100,000 h at $T_U = +25 \text{ }^\circ\text{C}$.

Mechanics/electronics

Supply voltage U_B	10 V DC ... 30 V DC ^{1) 2)}
Ripple	< 5 V _{pp} ³⁾
Current consumption	70 mA ⁴⁾
Switching output	Push-pull: PNP/NPN ⁵⁾
Number of switching outputs	2 (Q ₁ , Q ₂) ⁵⁾
Switching mode	Light switching ⁵⁾
Output current I_{max}	≤ 100 mA
Response time	≤ 5 ms ⁶⁾
Switching frequency	100 Hz ⁷⁾
Analog output	-
Input	MF _{in} = multifunctional input programmable
Connection type	Cable, 5-wire, 2 m ⁸⁾
Cable material	PVC
Conductor cross section	0.14 mm ²
Circuit protection	A ⁹⁾ B ¹⁰⁾ C ¹¹⁾
Protection class	III
Weight	48 g
Housing material	Plastic, VISTAL®
Optics material	Plastic, PMMA
Enclosure rating	IP67
Ambient operating temperature	-35 °C ... +50 °C ¹²⁾

- 1) Limit values. Operated in short-circuit protected network: max. 8 A.
- 2) V_S min at IO-Link operation = 18 V.
- 3) May not exceed or fall below U_V tolerances.
- 4) Without load. At $V_S = 24$ V.
- 5) Q₁, Q₂ = 2 switching thresholds, light switching.
- 6) Signal transit time with resistive load.
- 7) With light/dark ratio 1:1.
- 8) Do not bend below 0 °C.
- 9) A = V_S connections reverse-polarity protected.
- 10) B = inputs and output reverse-polarity protected.
- 11) C = interference suppression.
- 12) As of $T_a = 45 \text{ }^\circ\text{C}$, a max.load current $I_{max} = 50$ mA is permitted.
- 13) Below $T_U = -10 \text{ }^\circ\text{C}$ a warm-up time is necessary.

Ambient temperature, storage	-40 °C ... +70 °C
Warm-up time	< 15 min ¹³⁾
Initialization time	< 300 ms
UL File No.	NRKH.E181493

1) Limit values. Operated in short-circuit protected network: max. 8 A.

2) V_S min at IO-Link operation = 18 V.

3) May not exceed or fall below U_V tolerances.

4) Without load. At $V_S = 24$ V.

5) Q1, Q2 = 2 switching thresholds, light switching.

6) Signal transit time with resistive load.

7) With light/dark ratio 1:1.

8) Do not bend below 0 °C.

9) A = V_S connections reverse-polarity protected.

10) B = inputs and output reverse-polarity protected.

11) C = interference suppression.

12) As of $T_a = 45$ °C, a max.load current $I_{max} = 50$ mA is permitted.

13) Below $T_U = -10$ °C a warm-up time is necessary.

Safety-related parameters

MTTF_D	138 years
DC_{avg}	0 %

Communication interface

Communication interface	IO-Link V1.1
Communication Interface detail	COM2 (38,4 kBaud)
Cycle time	5 ms
Process data length	32 Bit
Process data structure	Bit 0 = switching signal Q ₀₁ Bit 1 = switching signal Q ₀₂ Bit 2 ... 8 = BDC 2 ... 8 Bit 9 ... 15 = empty Bit 16 ... 31 = distance value
Additional features	8 switching points for distance to object, of which 2 can be inverted, 1 switching point as switching window or configurable with hysteresis., multifunctional input: sender off, external teach, inactive
VendorID	26
DeviceID HEX	0x800097
DeviceID DEC	8388759

Classifications

eCl@ss 5.0	27270904
eCl@ss 5.1.4	27270904
eCl@ss 6.0	27270904
eCl@ss 6.2	27270904
eCl@ss 7.0	27270904
eCl@ss 8.0	27270904
eCl@ss 8.1	27270904
eCl@ss 9.0	27270904
eCl@ss 10.0	27270904

eCl@ss 11.0	27270904
eCl@ss 12.0	27270903
ETIM 5.0	EC002719
ETIM 6.0	EC002719
ETIM 7.0	EC002719
ETIM 8.0	EC002719
UNSPSC 16.0901	39121528

Dimensional drawing (Dimensions in mm (inch))

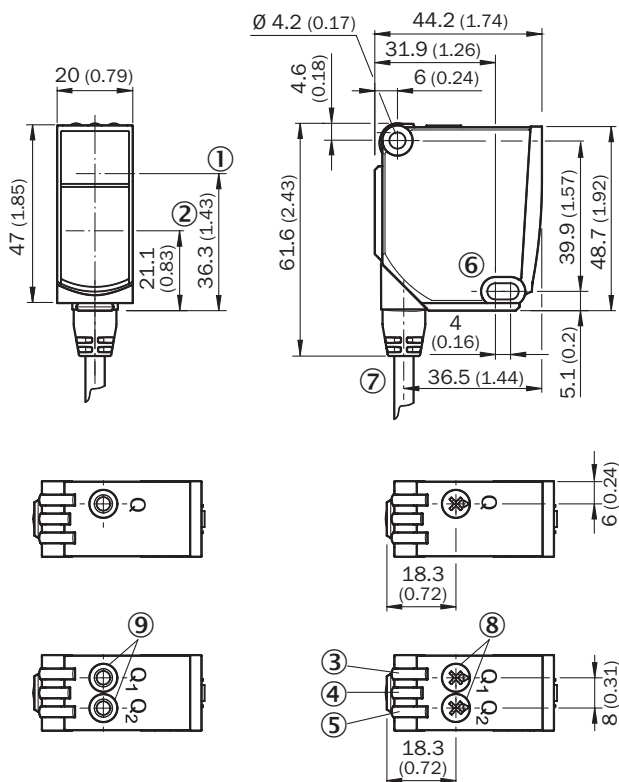

- ① Optical axis, sender
- ② Optical axis, receiver
- ③ LED indicator yellow: Status of received light beam
- ④ LED indicator green: power on
- ⑤ LED indicator yellow: Status of received light beam
- ⑥ Mounting hole, $\varnothing 4.2$ mm
- ⑦ Connection
- ⑧ Potentiometer
- ⑨ Single teach-in button

Connection diagram

Cd-290

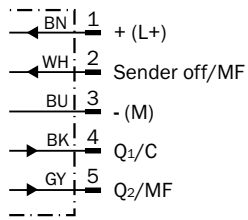

Characteristic curve

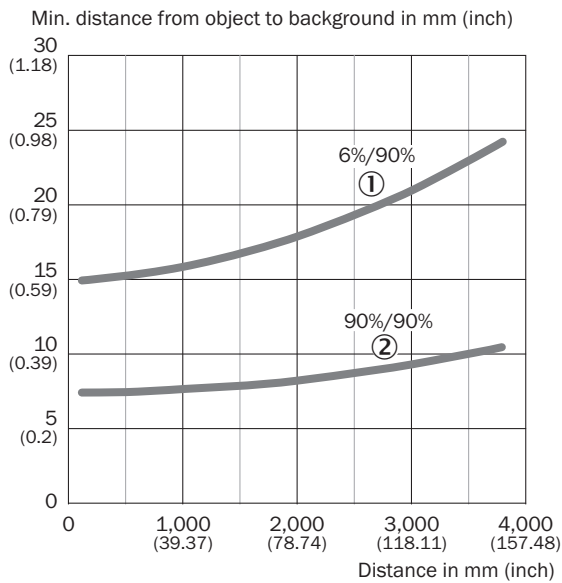

- ① Sensing range on black, 6% remission factor
- ② Sensing range on white, 90% remission factor

Light spot size

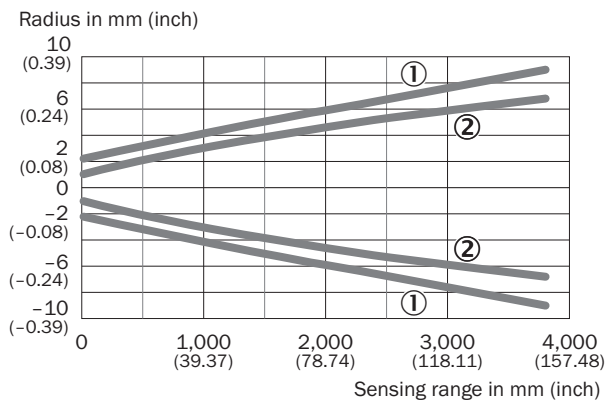

- ① Light spot horizontal
- ② Light spot vertical

Repeatability

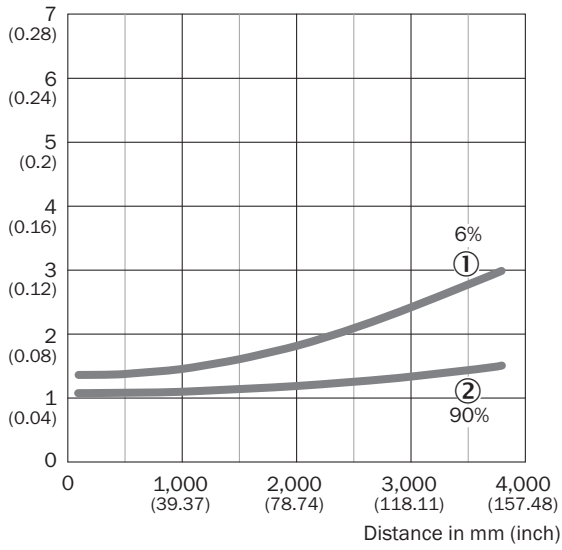

Repeatability in mm (inch)



- ① 6 % remission, on black
- ② 90 % remission, on white

Recommended accessories

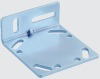
Other models and accessories → www.sick.com/PowerProx

	Brief description	Type	Part no.
Mounting brackets and plates			
	Mounting brackets	BEF-WTT12L	2078538
Plug connectors and cables			
	Head A: male connector, M12, 5-pin, straight Cable: unshielded For field bus technology	STE-1205-G	6022083

Recommended services

Additional services → www.sick.com/PowerProx

	Type	Part no.
Function Block Factory		
<ul style="list-style-type: none">• Description: The Function Block Factory supports common programmable logic controllers (PLCs) from various manufacturers, such as Siemens, Beckhoff, Rockwell Automation and B&R. More information on the FBF can be found <a _blank"="" href="https://fbf.cloud.sick.com target=">here.• Note: You can configure your function block at <a _blank"="" href="https://fbf.cloud.sick.com target=">Function Block Factory. As a login please use your SICK ID.	Function Block Factory	On request

SICK AT A GLANCE

SICK is one of the leading manufacturers of intelligent sensors and sensor solutions for industrial applications. A unique range of products and services creates the perfect basis for controlling processes securely and efficiently, protecting individuals from accidents and preventing damage to the environment.

We have extensive experience in a wide range of industries and understand their processes and requirements. With intelligent sensors, we can deliver exactly what our customers need. In application centers in Europe, Asia and North America, system solutions are tested and optimized in accordance with customer specifications. All this makes us a reliable supplier and development partner.

Comprehensive services complete our offering: SICK LifeTime Services provide support throughout the machine life cycle and ensure safety and productivity.

For us, that is “Sensor Intelligence.”

WORLDWIDE PRESENCE:

Contacts and other locations –www.sick.com