

Odace

Unshielded Connector

Cat 6

Cat 5e

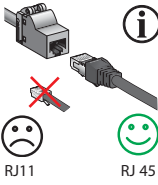
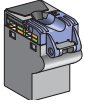

RJ11

RJ45

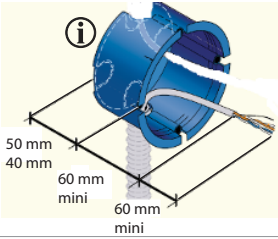

S5--471
S5--475

S5--481
S5--485

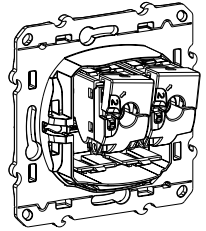
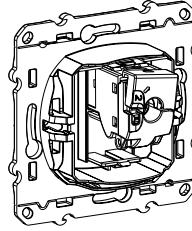
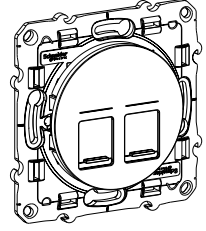
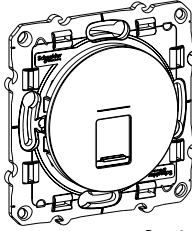

A U/UTP

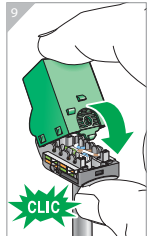
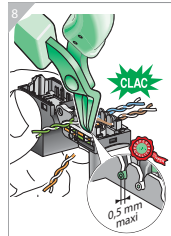
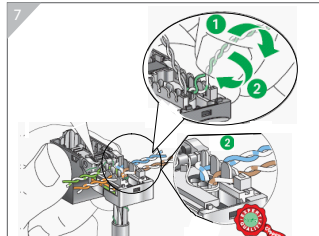
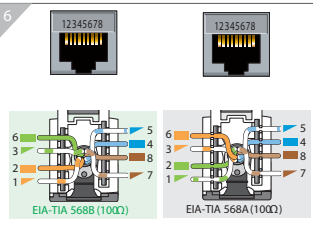
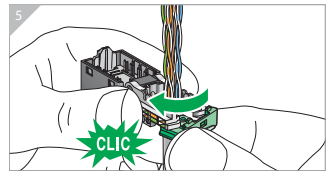
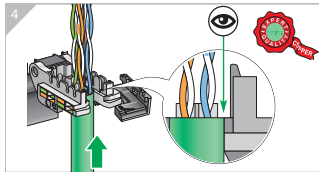
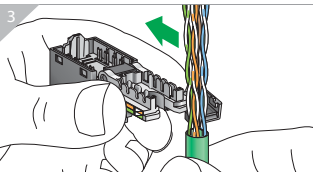
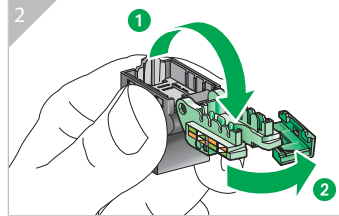
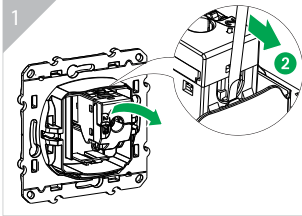
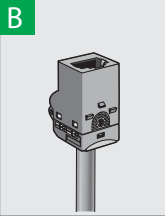
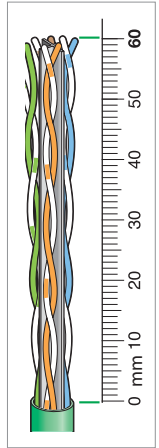
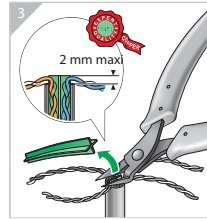
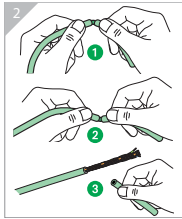
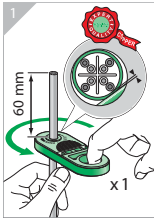
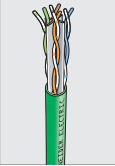

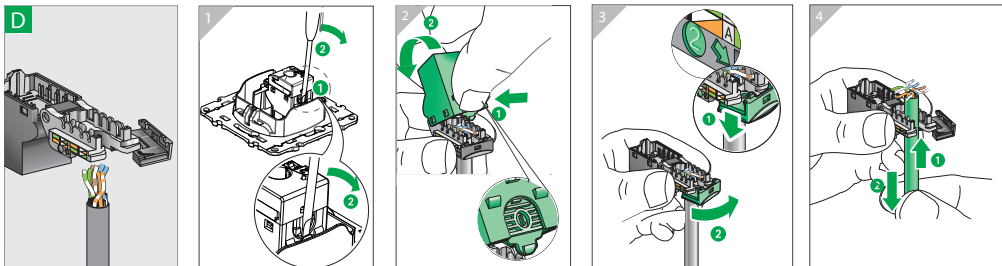
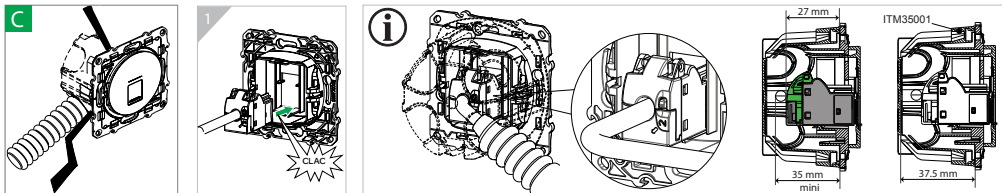

S520xxx

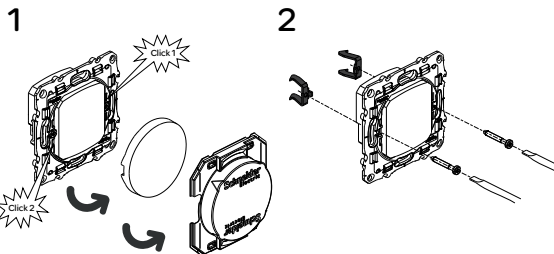

S525xxx

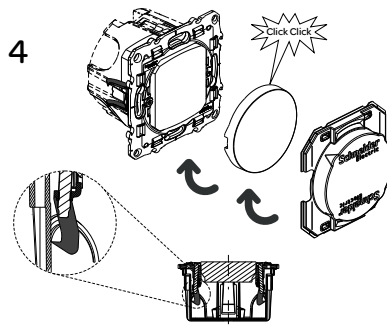
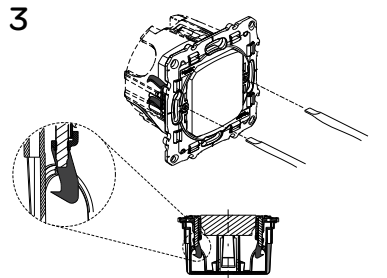
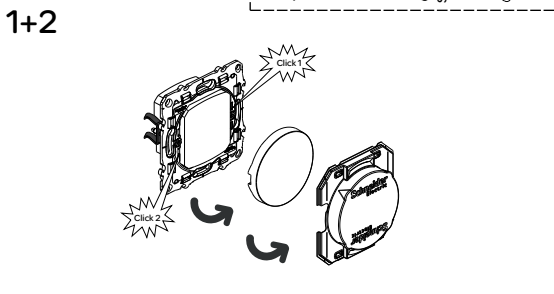

fr Ce produit doit être installé, connecté et utilisé conformément aux normes applicables et/ou règles d'installation.

Du fait que les normes, les spécifications et les schémas peuvent être modifiés, nous vous recommandons de vérifier que la documentation de cette publication soit mise à jour.

es Este producto debe ser instalado, conectado y utilizado en acuerdo con las normas aplicables y/o las reglas de instalación.

Dado que las normas, las especificaciones y los diseños se desarrollan de vez en cuando, se recomienda se aseguren que la información dada en esta publicación sea la correcta.

nl Dit product moet geïnstalleerd, aangesloten en gebruikt worden in overeenstemming met de geldende normen en/of installatievoorschriften. Omdat normen, specificaties en modellen kunnen evolueren in de tijd, altijd vragen om bevestiging van de informatie in deze publicatie.

pt Este produto deve ser instalado, ligado e utilizado de acordo com as normas aplicáveis e/ou regras de instalação. Dado que as normas, especificações e esquemas são atualizados periodicamente, solicite sempre confirmação da informação contida nesta publicação.

en This product must be installed, connected and used in compliance with applicable standards and/or installation regulations.

As standards, specifications and designs develop from time to time, always ask for confirmation of the information given in this publication.

