



**TBT-1PASE3506GZ**

TBT

**RESISTANCE THERMOMETER**

**SICK**  
Sensor Intelligence.



Illustration may differ



## Ordering information

Type	Part no.
TBT-1PASE3506GZ	6043037

Other models and accessories → [www.sick.com/TBT](http://www.sick.com/TBT)

## Detailed technical data

### Features

<b>Measuring range</b>	-50 °C ... +150 °C
<b>Sensor element</b>	Pt100
<b>Output signal</b>	Pt100, 4-wire

### Mechanics/electronics

<b>Process connection</b>	Compression fitting G ½ B, stainless steel ferrule
<b>Insertion length/diameter of probe</b>	350 mm / 6 mm
<b>Wetted parts</b>	Stainless steel 1.4571
<b>Pressure resistance</b>	Max. 100 bar with supplied compression fitting with stainless steel ferrule
<b>Housing material</b>	Aluminum
<b>Connection type</b>	Cable gland M16 x 1.5 <sup>1)</sup>
<b>Enclosure rating</b>	IP65 <sup>2)</sup>
<b>Measuring current</b>	0.3 mA ... 1 mA
<b>Electrical safety</b>	Protection class: III, dielectric strength: 100 V
<b>Protection class III</b>	✓
<b>CE-conformity</b>	2004/108/EC, EN 61326-2-3
<b>RoHS certificate</b>	✓
<b>Weight</b>	Ca. 155 g (depending on configuration)
<b>Initialization time</b>	< 1 ms

<sup>1)</sup> The enclosure rating classes specified only apply while the thermometer is connected with female connectors that provide the corresponding enclosure rating.

<sup>2)</sup> IP enclosure rating as per IEC 60529.

### Performance

<b>Accuracy of sensor element</b>	Class A according to IEC 60751
<b>Transmitter accuracy</b>	≤ ± 0.1 % of span
<b>Transmitter linearity</b>	≤ 0.1 % of span
<b>Response time</b>	Response time $t_{50}$ : ≤ 5.8 s <sup>1)</sup> Response time $t_{90}$ : ≤ 15.5 s <sup>1)</sup>

<sup>1)</sup> Depending on sensor configuration, according to IEC 60751.

Ambient data

<b>Ambient temperature</b>	-40 °C ... +125 °C
<b>Storage and transport temperature</b>	-40 °C ... +60 °C
<b>Shock resistance according to IEC 60751</b>	500 g
<b>Vibration resistance according to IEC 60751</b>	3 g

Classifications

<b>eCl@ss 5.0</b>	27200208
<b>eCl@ss 5.1.4</b>	27200208
<b>eCl@ss 6.0</b>	27200208
<b>eCl@ss 6.2</b>	27200208
<b>eCl@ss 7.0</b>	27200208
<b>eCl@ss 8.0</b>	27200208
<b>eCl@ss 8.1</b>	27200208
<b>eCl@ss 9.0</b>	27200208
<b>eCl@ss 10.0</b>	27200208
<b>eCl@ss 11.0</b>	27200208
<b>eCl@ss 12.0</b>	27200208
<b>ETIM 5.0</b>	EC002994
<b>ETIM 6.0</b>	EC002994
<b>ETIM 7.0</b>	EC002994
<b>ETIM 8.0</b>	EC002994
<b>UNSPSC 16.0901</b>	41112211

**Dimensional drawing** (Dimensions in mm (inch))

Dimensional drawing: cylindrical threads

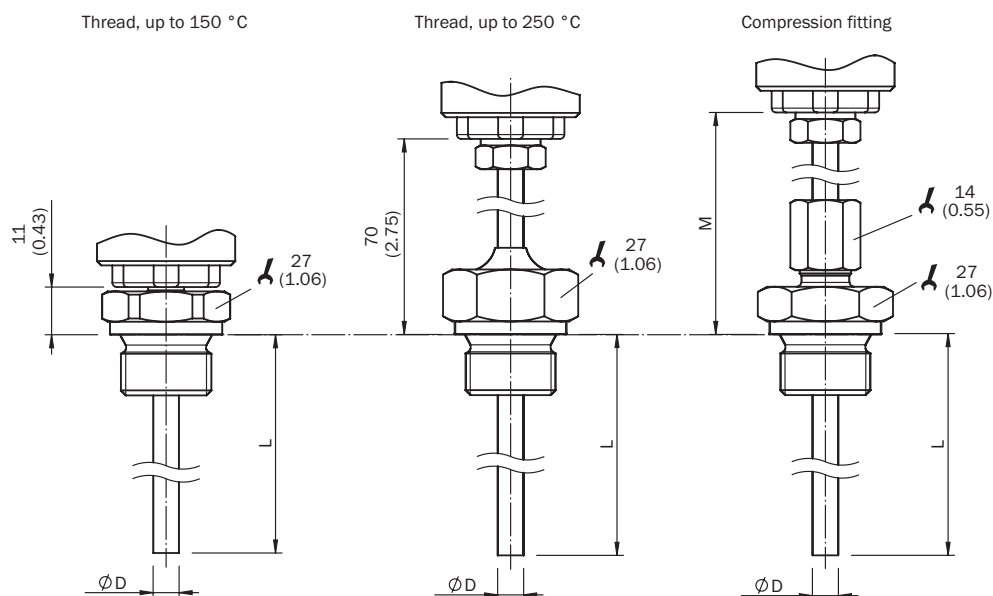

Dimensional drawing: conical threads

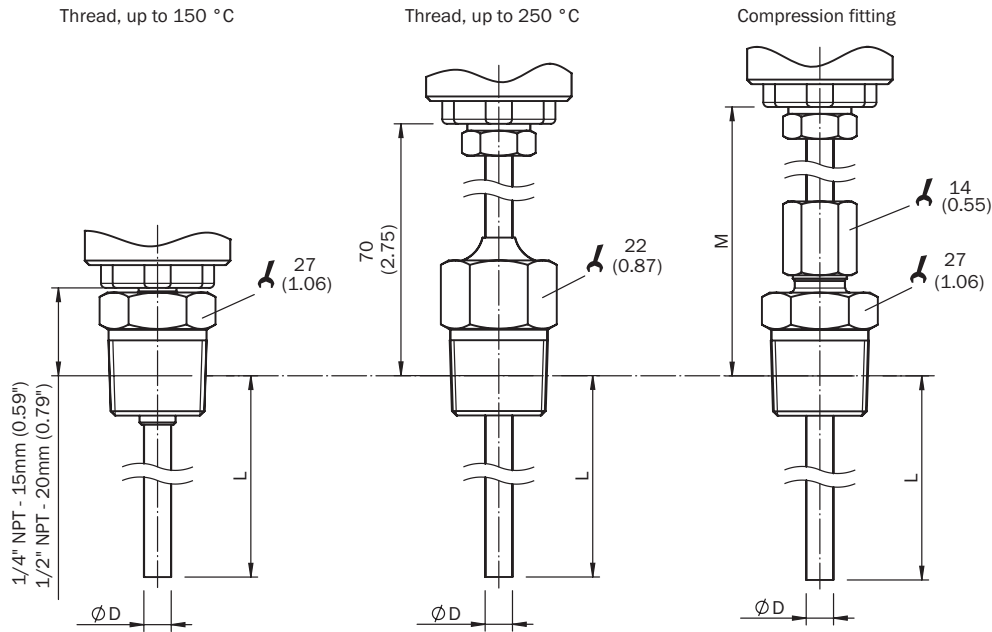

Dimensional drawing: housing, without process connection



Connection type

Cable entry M16 x 1.5, cable cross-section up to 0.75 mm<sup>2</sup>, output signal Pt100

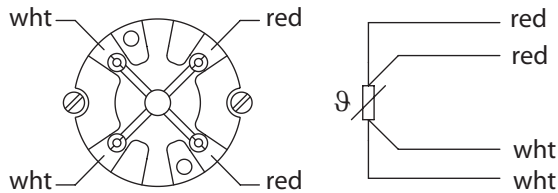

## SICK AT A GLANCE

SICK is one of the leading manufacturers of intelligent sensors and sensor solutions for industrial applications. A unique range of products and services creates the perfect basis for controlling processes securely and efficiently, protecting individuals from accidents and preventing damage to the environment.

We have extensive experience in a wide range of industries and understand their processes and requirements. With intelligent sensors, we can deliver exactly what our customers need. In application centers in Europe, Asia and North America, system solutions are tested and optimized in accordance with customer specifications. All this makes us a reliable supplier and development partner.

Comprehensive services complete our offering: SICK LifeTime Services provide support throughout the machine life cycle and ensure safety and productivity.

For us, that is “Sensor Intelligence.”

## WORLDWIDE PRESENCE:

Contacts and other locations –[www.sick.com](http://www.sick.com)