

Part number

PEW 1663 SM



Wall-mounting plug, PLUSO series, 2 poles + PE, 6 h (blue), 16 A, 200 ÷ 250 V

Product description

Product type	Plug Wall-mounting
Series	PEW...SM, PLUSO
N. of poles	2 poles + 
Clock position	6

Technical data

Current	16 A
Voltage	200 ÷ 250 V
IP degree of protection	IP67

Further technical details

Weight	281,00 g
Operating temperature range (min, max)	-25°C ... +40°C

Material properties

Colour	RAL 7035 grey, RAL 5015 blue
RoHs conformity	Compliant with exemption 6(c): copper alloy containing up to 4% lead by weight
China RoHs - EFUP	50
REACH SVHC substances	Yes Lead
SCIP number	Ca7de37f-add8-4b77-9861-279c94903ade

Approvals / Standards

Reference standard	EN 60309-1 and -2
---------------------------	-------------------

General ordering information

EAN13 code	8015747072731
-------------------	---------------

Packaging Information

Packaging length	330,00 mm
Packaging height	175,00 mm
Packaging width	295,00 mm
Packaging weight	3,15 kg
Packaging volume	17,04 dm ³
Packaging description	Carton box
Packaging quantity	10 Pcs
Packaging EAN code	8015747072748

Part number

PEW 1663 SM



Catalogue drawings

(16 / 32A) PEW ... SM

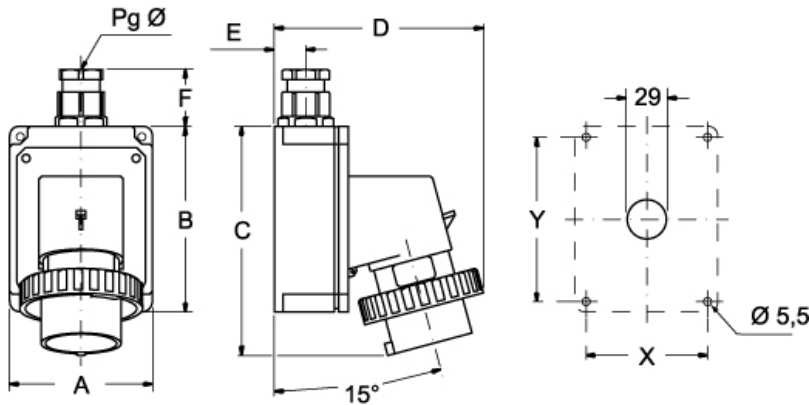

PEW ... SM	A	B	C	D	E	F	X	Y	Pg Ø
16A 2P+⊕	75	115	144	126	19	35	65	105	16
3P+⊕	75	115	144	134	19	35	65	105	16
3P+N+⊕	100	130	164	145	22	42	85	115	21
32A 2P+⊕	100	130	178	154	22	42	85	115	21
3P+⊕	100	130	178	154	22	42	85	115	21
3P+N+⊕	100	130	178	160	22	42	85	115	21

Notes

Dimensions shown in mm are not binding and may be changed without notice.

- Compliant with EN 60309-1 and -2
- Enclosure, insert and locking ring in insulating, thermoplastic, self-extinguishing material
- PE...SM types (IP44), enclosure colour coded according to the operating voltage, top entry with threaded grommet (replaceable with cable gland)
- PEW...SM types (IP67), RAL 7035 grey enclosure, locking ring with gasket colour coded according to the operating voltage, top entry with cable gland
- Terminals with retained screws
- 63A, 125A: with pilot contact
- Nickel-plated contacts, available on request for 16A and 32A (standard on 63A and 125A). For the code of products with nickel-plated contacts (socket holes, plug pins), add "N" to the pre-code of the corresponding standard product code; for example: PE becomes PEN and PEW becomes PEWN.
- 125A: with terminal block for the anchoring of incoming cables, already connected to socket
- IP44 and IP67 degrees of protection (EN 6052)