



Product designation				MINIATURE RELAYS
Product type designation				HR502C
Contact characteristics				
Contact configuration				2 C/O
Rated insulation voltage U_i IEC/EN	V			250
Rated impulse withstand voltage U_{imp}	kV			6
IEC Conventional free air thermal current I_{th}	A			8
Maximum instantaneous current	A			10
Rated current (I_n)	A			8
Relay control voltage	V			12VAC
Max contrrollable power in		AC-1	W	2000
		AC-15	VA	150
Rated operating power AC-1			VA	2000
Rated operating power AC-15	230 VAC	VA	150	
Rated operating current DC-1		30V	A	8
		110V	A	0.3
		220V	A	0.1
Minimum switching load		V / mA	5 / 100	
Contact impedance		m Ω	100	
Contact material		Ag/Ni		
Operating times				
Closing		ms	<15	
Opening		ms	<15	
Operations				
Mechanical life		cycles	10000000	
Electrical life AC1		cycles	50000	
Coil characteristics				
Average coil consumption AC at 20°C		VA	1	
Average coil consumption DC at 20°C		W	0.4	
Operating range		Closing	% U_n	70...110
		Opening	% U_n	20...55
Maximum cycle frequency		cycles/h	3600	
Mechanical features				
Max socket terminal tightening torque		Nm	0.6	
Socket screw tightening tool (cross / flat blade)		PH1 / 4.5mm		
Conductor section	AWG/Kcmil	min	20	
		max	14	

IEC

min	mm ²	0.5
max	mm ²	2.5

Operating position

normal	Any
--------	-----

Fixing

On 35mm DIN rail and with screw

Ambient conditions

Temperature

Operating temperature

min	°C	-40
max	°C	+70

Storage temperature

min	°C	-40
max	°C	+85

Other features

Indication

Yes

Mechanical contact position indicator

Yes

Mechanical test actuator

Yes

Dimensions

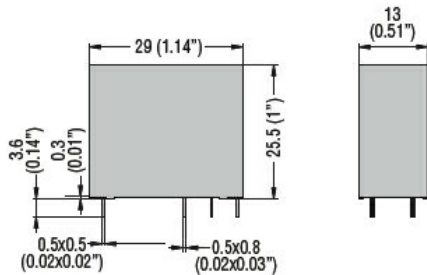

PCB layout

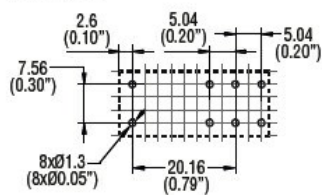

Wiring diagrams

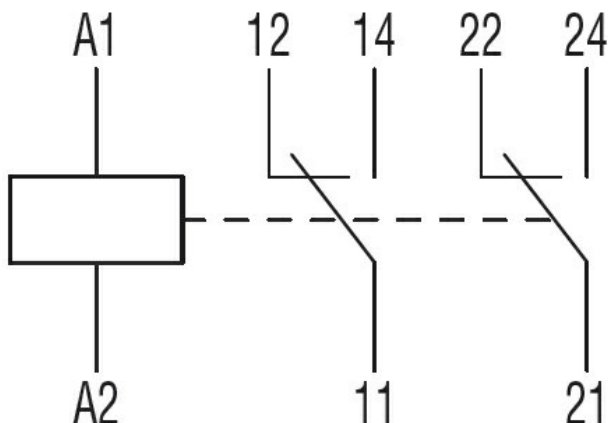

Certifications and compliance

Compliance

IEC/EN 61810

Certificates

CSA

cURus

EAC

VDE

ETIM classification

ETIM 8.0

EC001437 -
Switching relay