



# MICS3-CCAZ90AA1

microScan3

SAFETY LASER SCANNERS

**SICK**  
Sensor Intelligence.



Illustration may differ

### Ordering information

Integration in the control system	Sub product family	Protective field range	Number of fields	Number of monitoring cases	Connection type	Type	Part no.
Local inputs and outputs (I/O), EFI-pro	microScan3 Pro I/O - EFI-pro	9 m	128	128	M12	MICS3-CCAZ90AA1	1110036

Replacement sensor without system plug; only functional in combination with system plug;

Replacement sensor for 1110037

Other models and accessories → [www.sick.com/microScan3](http://www.sick.com/microScan3)



### Detailed technical data

#### Features

<b>Sub product family</b>	microScan3 Pro I/O - EFI-pro
<b>Model</b>	Sensor without system plug
<b>Application</b>	Indoor
<b>Protective field range</b>	9 m
<b>Warning field range</b>	64 m
<b>Collision protection field range</b>	19 m (on reference target)
<b>Number of simultaneously monitored fields</b>	≤ 4 <sup>1)</sup>
<b>Number of fields</b>	128
<b>Number of monitoring cases</b>	128
<b>Scanning angle</b>	275°
<b>Resolution (can be configured)</b>	30 mm 40 mm 50 mm 60 mm 70 mm 150 mm 200 mm
<b>Angular resolution</b>	0.1°
<b>Response time</b>	≥ 90 ms
<b>Protective field supplement</b>	100 mm

<sup>1)</sup> Protection, warning or contour detection fields.

#### Safety-related parameters

<b>Type</b>	Type 3 (IEC 61496)
<b>Safety integrity level</b>	SIL 2 (IEC 61508)

<b>Category</b>	Category 3 (EN ISO 13849)
<b>Performance level</b>	PL d (EN ISO 13849)
<b>PFH<sub>D</sub> (mean probability of a dangerous failure per hour)</b>	$8.0 \times 10^{-8}$
<b>T<sub>M</sub> (mission time)</b>	20 years (EN ISO 13849)
<b>Safe state in the event of a fault</b>	At least one OSSD is in the OFF state. The safety outputs via the network are logic 0.

## Functions

<b>Restart interlock</b>	✓
<b>External device monitoring (EDM)</b>	✓
<b>Multiple sampling</b>	✓
<b>Monitoring case switching</b>	✓
<b>Simultaneous monitoring</b>	✓
<b>Static protective field switching</b>	✓
<b>Collision protection field</b>	✓
<b>Safe contour detection</b>	✓
<b>Contour as a reference</b>	✓
<b>Integrated configuration memory</b>	✓
<b>Measured data output</b>	Via Ethernet
<b>Safe SICK device communication via EFI-pro</b>	✓

## Interfaces

<b>Connection type</b>	
Voltage supply	1 x male connector, M12, 4-pin, A-coded
Local inputs and outputs (I/O)	2 x female connector, M12, 17-pin, A-coded
Dynamic switching signals	2 x female connector, M12, 8-pin, A-coded
Fieldbus, industrial network	2 x M12 female connectors, 4-pin, D-coded
<b>Outputs</b>	
OSSD pairs	4
Safety outputs via network	4
Universal outputs	4 <sup>1)</sup>
<b>Inputs</b>	
Universal inputs	≤ 16 <sup>1)</sup>
Dynamic switching signals	2
Static control inputs	≤ 8
<b>Configuration method</b>	PC with Safety Designer (Configuration and Diagnostic Software)
<b>Configuration and diagnostics interface</b>	USB 2.0, Mini-USB, Ethernet
<b>Data interface</b>	
Services	EtherNet/IP™ CIP Safety™ CoLa 2 (configuration and diagnostics using Safety Designer) Data output DHCP SNMP

<sup>1)</sup> Freely configurable.

	SNTP (client and server)
<b>Fieldbus, industrial network</b>	EFI-pro
RPI (requested packet interval)	5 ms ... 1,000 ms, multiple of 5 ms
<b>Display elements</b>	Graphic color display, LEDs

<sup>1)</sup> Freely configurable.

### Electrical data

<b>Protection class</b>	III (EN 61140)
<b>Supply voltage V<sub>s</sub></b>	24 V DC (16.8 V DC ... 30 V DC)
<b>Power consumption typical</b>	8.1 W (without output load)

### Mechanical data

<b>Dimensions (W x H x D)</b>	112 mm x 163 mm x 111.1 mm
<b>Housing material</b>	Aluminum
<b>Housing color</b>	RAL 1021 (yellow), RAL 9005 (black)
<b>Optics cover material</b>	Polycarbonate
<b>Optics cover surface finish</b>	Outside with scratch-resistant coating

### Ambient data

<b>Enclosure rating</b>	IP65 (IEC 60529)
<b>Ambient light immunity</b>	≤ 3,000 lx (IEC 61496-3)
<b>Ambient operating temperature</b>	-10 °C ... +50 °C
<b>Storage temperature</b>	-25 °C ... +70 °C
<b>Vibration resistance</b>	IEC 60068-2-6, IEC 60068-2-64, IEC 60721-3-5, IEC TR 60721-4-3, IEC 61496-1, IEC 61496-3
Class	5M1 (IEC 60721-3-5) 3M4 (IEC TR 60721-4-3)
<b>Shock resistance</b>	IEC 60068-2-27, IEC 60721-3-5, IEC TR 60721-4-3, IEC 61496-1, IEC 61496-3
Class	5M1 (IEC 60721-3-5) 3M4 (IEC TR 60721-4-3)
Continuous shock	100 m/s <sup>2</sup> , 16 ms 150 m/s <sup>2</sup> , 6 ms
<b>EMC</b>	IEC 61496-1, IEC 61000-6-2, IEC 61000-6-4

### Other information

<b>Type of light</b>	Pulsed laser diode
<b>Wave length</b>	845 nm
<b>Detectable remission factor</b>	1.8% to several 1000%
<b>Laser class</b>	1M (21 CFR 1040.10 and 1040.11, IEC 60825-1)

### Classifications

<b>ECLASS 5.0</b>	27272705
<b>ECLASS 5.1.4</b>	27272705
<b>ECLASS 6.0</b>	27272705
<b>ECLASS 6.2</b>	27272705
<b>ECLASS 7.0</b>	27272705
<b>ECLASS 8.0</b>	27272705

<b>ECLASS 8.1</b>	27272705
<b>ECLASS 9.0</b>	27272705
<b>ECLASS 10.0</b>	27272705
<b>ECLASS 11.0</b>	27272705
<b>ECLASS 12.0</b>	27272705
<b>ETIM 5.0</b>	EC002550
<b>ETIM 6.0</b>	EC002550
<b>ETIM 7.0</b>	EC002550
<b>ETIM 8.0</b>	EC002550
<b>UNSPSC 16.0901</b>	39121528

Dimensional drawing (Dimensions in mm (inch))

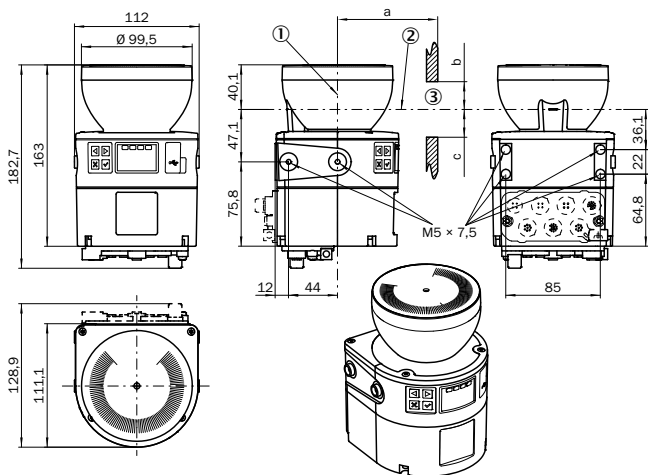

- ① Mirror axis of rotation
- ② Scan plane
- ③ Required viewing slit (a: length of the viewing slit, b: minimum height above the scan plane, c: minimum height below the scan plane. See the operating instructions for details.)

Pin assignment

Ethernet (XF1, XF2)

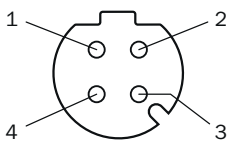

Pin	Designation	Description
1	TX+	Send data +
2	RX+	Receive data +
3	TX-	Send data -
4	RX-	Receive data -
Thread	SH	Shielding

Pin	Designation	Description
For details see operating instructions		

### Voltage supply (XD1)

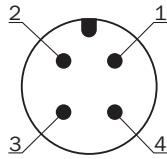

Pin	Designation	Description
1	+24 V DC	Supply voltage +24 V DC
2	n.c.	Not connected
3	0 V DC	Supply voltage 0 V DC
4	FE	Functional earth/shielding
For details see operating instructions		

### Local inputs and outputs (XG1)

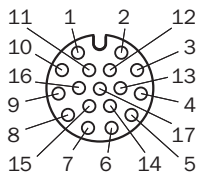

Pin	Designation	Description
1	OSSD 1.A	OSSD pair 1, OSSD A
2	OSSD 1.B	OSSD pair 1, OSSD B
3	OSSD 2.A	OSSD pair 2, OSSD A
4	OSSD 2.B	OSSD pair 2, OSSD B
5	Uni-I 01	Universal input 1, configurable
6	Uni-I 02	Universal input 2, configurable
7	Uni-I 03	Universal input 3, configurable
8	Uni-I 04	Universal input 4, configurable
9	Uni-I 05	Universal input 5, configurable
10	Uni-I 06	Universal input 6, configurable
11	Uni-I 07	Universal input 7, configurable
12	Uni-I 08	Universal input 8, configurable
13	Uni-I 09	Universal input 9, configurable
14	Uni-I 10	Universal input 10, configurable
15	Uni-O 01	Universal output 1
16	Uni-O 02	Universal output 2
17	0 V DC	Voltage for inputs and outputs (0 V DC) *

\* If at least one connection of the female connector is used, this 0 V connection must be connected in the control cabinet to 0 V DC of the power supply unit using a low-impedance and star-point connection.

For details see operating instructions

Local inputs and outputs (XG4)

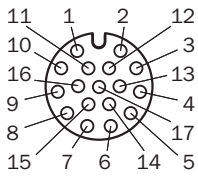

Pin	Designation	Description
1	OSSD 3.A	OSSD pair 3, OSSD A
2	OSSD 3.B	
3	OSSD 4.A	OSSD pair 4, OSSD A
4	OSSD 4.B	
5	n.c.	Not connected
6	n.c.	Not connected
7	n.c.	Not connected
8	n.c.	Not connected
9	Uni-I 11	Universal input 11, configurable
10	Uni-I 12	Universal input 12, configurable
11	Uni-I 13	Universal input 13, configurable
12	Uni-I 14	Universal input 14, configurable
13	Uni-I 15	Universal input 15, configurable
14	Uni-I 16	Universal input 16, configurable
15	Uni-O 03	Universal output 3
16	Uni-O 04	Universal output 4
17	0 V DC	Voltage for inputs and outputs (0 V DC) *

\* If at least one connection of the female connector is used, this 0 V connection must be connected in the control cabinet to 0 V DC of the power supply unit using a low-impedance and star-point connection.

For details see operating instructions

Dynamic control input (XG2, XG3)

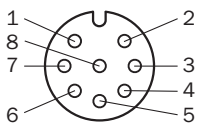









Pin	Designation	Description
1	n.c.	Not connected
2	Inc 0°	Incremental encoder signal (0°)
3	n.c.	Not connected
4	Inc 90°	Incremental encoder signal (90°)
5	n.c.	Not connected
6	n.c.	Not connected
7	0 V Inc	Supply voltage for incremental encoder (0 V DC)
8	24 V DC Inc	Supply voltage for incremental encoder (+24 V DC)

Pin	Designation	Description
For details see operating instructions		

### Recommended accessories

Other models and accessories → [www.sick.com/microScan3](http://www.sick.com/microScan3)

Brief description	Type	Part no.
<b>Mounting brackets and plates</b>		
 <p>1 piece, mounting bracket with protection of optics hood, Stainless steel V2A (1.4301), powder-coated IGP-DURA face 5803A</p>	1b mounting kit	2074242
 <p>1 piece, mounting bracket, heavy-duty version, with protection cover, for floor mounting, height adjustment possible from 90 ... 310 mm, scanner tilt angle: ± 5°. Additional mounting brackets are not required. Steel, painted (RAL 1021)</p>	Heavy-duty mounting kit for floor mounting	2102289
 <p>1 piece, mounting bracket 150 mm for floor mounting of microScan3, stainless steel, Bracket and 4 x M5 screws for attaching the microScan3</p>	Mounting bracket 150 mm for floor mounting of microScan3	2112950
 <p>1 piece, mounting bracket 300 mm for floor mounting of microScan3, stainless steel, Bracket and 4 x M5 screws for attaching the microScan3</p>	Mounting bracket 300 mm for floor mounting of microScan3	2112951
 <p>1 piece, mounting bracket, Stainless steel V2A (1.4301), powder-coated IGP-DURA face 5803A</p>	Mounting kit 1a	2073851
 <p>1 piece, alignment bracket, alignment with cross-wise axis and depth axis possible, distance between mounting surface and device: 22.3 mm, only in conjunction with mounting kit 1a (2073851) or 1b (2074242), Stainless steel V2A (1.4301), powder-coated IGP-DURA face 5803A</p>	Mounting kit 2a	2073852
 <p>1 piece, Alignment bracket, alignment with cross-wise axis and depth axis possible, distance between mounting surface and device: 52.3 mm, only in conjunction with mounting kit 1a (2073851) or 1b (2074242), Stainless steel V2A (1.4301), powder-coated IGP-DURA face 5803A</p>	Mounting kit 2b	2074184
<b>Plug connectors and cables</b>		
 <ul style="list-style-type: none"> <li>• <b>Connection type head A:</b> Female connector, M12, 4-pin, straight</li> <li>• <b>Connection type head B:</b> Flying leads</li> <li>• <b>Signal type:</b> Sensor/actuator cable</li> <li>• <b>Cable:</b> 5 m, 4-wire, PUR, halogen-free</li> <li>• <b>Description:</b> Sensor/actuator cable, unshielded, Head A: female connector, M12, 4-pin, straight Head B: cable Cable: for voltage supply, suitable for drag chains, PUR, halogen-free, unshielded, 4 x 0.75 mm<sup>2</sup>, Ø 5.9 mm</li> <li>• <b>Connection systems:</b> Flying leads</li> <li>• <b>Application:</b> Zones with oils and lubricants, Drag chain operation</li> </ul>	DOL-1204G05MC75KM0	2079291
 <ul style="list-style-type: none"> <li>• <b>Connection type head A:</b> Female connector, M12, 4-pin, angled</li> <li>• <b>Connection type head B:</b> Flying leads</li> <li>• <b>Signal type:</b> Sensor/actuator cable</li> <li>• <b>Cable:</b> 5 m, 4-wire, PUR, halogen-free</li> <li>• <b>Description:</b> Sensor/actuator cable, unshielded, Head A: female connector, M12, 4-pin, angled Head B: cable Cable: for voltage supply, suitable for drag chains, PUR, halogen-free, unshielded, 4 x 0.75 mm<sup>2</sup>, Ø 5.9 mm</li> <li>• <b>Connection systems:</b> Flying leads</li> <li>• <b>Application:</b> Zones with oils and lubricants, Drag chain operation</li> </ul>	DOL-1204W05MC75KM0	2079294



	Brief description	Type	Part no.
	<ul style="list-style-type: none"> <li>• <b>Connection type head A:</b> Male connector, M12, 17-pin, straight</li> <li>• <b>Connection type head B:</b> Flying leads</li> <li>• <b>Signal type:</b> Sensor/actuator cable</li> <li>• <b>Cable:</b> 10 m, 17-wire, PUR</li> <li>• <b>Description:</b> Sensor/actuator cable, unshielded</li> <li>• <b>Application:</b> Zones with oils and lubricants</li> </ul>	YM2A1D-100UV1XLEAX	2118016
	<ul style="list-style-type: none"> <li>• <b>Connection type head A:</b> Male connector, M12, 17-pin, angled</li> <li>• <b>Connection type head B:</b> Flying leads</li> <li>• <b>Signal type:</b> Sensor/actuator cable</li> <li>• <b>Cable:</b> 10 m, 17-wire, PUR</li> <li>• <b>Description:</b> Sensor/actuator cable, unshielded</li> <li>• <b>Application:</b> Zones with oils and lubricants</li> </ul>	YN2A1D-100UV1XLEAX	2118011
	<ul style="list-style-type: none"> <li>• <b>Connection type head A:</b> Male connector, M12, 4-pin, angled, D-coded</li> <li>• <b>Connection type head B:</b> Male connector, RJ45, 8-pin, straight</li> <li>• <b>Signal type:</b> Ethernet</li> <li>• <b>Cable:</b> 20 m, 4-wire, CAT5, CAT5e, PUR, halogen-free</li> <li>• <b>Description:</b> Ethernet, shielded, Head A: male connector, M12, 4-pin, angled, D coded Head B: male connector, RJ45, 8-pin, straight Cable: PUR, halogen-free, shielded, 2 x 2 x 0.14 mm<sup>2</sup>, Ø 6.4 mm</li> </ul>	SSL-2J04-H20ME	6063701
	<ul style="list-style-type: none"> <li>• <b>Connection type head A:</b> Female connector, M12, 8-pin, straight, A-coded</li> <li>• <b>Connection type head B:</b> Male connector, M12, 8-pin, straight, A-coded</li> <li>• <b>Signal type:</b> Sensor/actuator cable</li> <li>• <b>Cable:</b> 2 m, 8-wire, PUR, halogen-free</li> <li>• <b>Description:</b> Sensor/actuator cable, shielded</li> <li>• <b>Application:</b> Zones with oils and lubricants, Drag chain operation</li> </ul>	YF2A28-020UA6M2A28	2096105
	<ul style="list-style-type: none"> <li>• <b>Connection type head A:</b> Male connector, M12, 4-pin, straight, D-coded</li> <li>• <b>Connection type head B:</b> Male connector, RJ45, 4-pin, straight</li> <li>• <b>Signal type:</b> Ethernet, PROFINET</li> <li>• <b>Cable:</b> 5 m, 4-wire, PUR, halogen-free</li> <li>• <b>Description:</b> Ethernet, PROFINET, shielded</li> <li>• <b>Application:</b> Drag chain operation, Zones with oils and lubricants</li> </ul>	YM2D24-050PN1MRJA4	2106184
	<ul style="list-style-type: none"> <li>• <b>Connection type head A:</b> Male connector, M12, 4-pin, angled, D-coded</li> <li>• <b>Connection type head B:</b> Male connector, RJ45, 4-pin, straight</li> <li>• <b>Signal type:</b> Ethernet, PROFINET</li> <li>• <b>Cable:</b> 5 m, 4-wire, PUR, halogen-free</li> <li>• <b>Description:</b> Ethernet, PROFINET, shielded</li> <li>• <b>Application:</b> Drag chain operation, Zones with oils and lubricants</li> </ul>	YN2D24-050PN1MRJA4	2106163
	<ul style="list-style-type: none"> <li>• <b>Connection type head A:</b> System plug</li> <li>• <b>Description:</b> Integrated configuration memory, System connection; %voltage supply: 1 x M12 male connector, 4-pin, A-coded; %local inputs and outputs (I/O): 2 x M12 female connector, 17-pin, A-coded; %dynamic control inputs: 2 x M12 female connector, 8-pin, A-coded; %fieldbus, industrial network: 2 x M12 female connector, 4-pin, D-coded;</li> </ul>	MICSX-CAAAMDMD1	2115434
Others			
	<ul style="list-style-type: none"> <li>• <b>Brief description:</b> The software visualizes diagnostic and device information from safety laser scanners in real time, helping to identify error causes faster and reduce maintenance time.</li> <li>• <b>Supported products:</b> All microScan3 variants (except for microScan3 Core I/O variants), outdoorScan3 Pro - EtherNet/IP</li> <li>• <b>Version:</b> 1.0</li> <li>• <b>Note:</b> With purchase, you accept the product description available under Downloads &gt; Documentation in connection with the &lt;a href="https://www.sick.com/tools/tac/en/General-Terms-Conditions-Supply-Software-Products-AVB-Software-SICK.pdf" target="_blank"&gt;General Terms and Conditions for the Supply of Software Products (AVB Software SICK)&lt;/a&gt;., With purchase, you accept the product description available under Downloads &gt; Documentation in connection with the &lt;a href="https://www.sick.com/tools/tac/en/General-Terms-Conditions-Supply-Software-Products-AVB-Software-SICK.pdf" target="_blank"&gt;General Terms and Conditions for the Supply of Software Products (AVB Software SICK)&lt;/a&gt;.</li> </ul>	SOW/VTL-LI007PCWIO	1116788

## SICK AT A GLANCE

SICK is one of the leading manufacturers of intelligent sensors and sensor solutions for industrial applications. A unique range of products and services creates the perfect basis for controlling processes securely and efficiently, protecting individuals from accidents and preventing damage to the environment.

We have extensive experience in a wide range of industries and understand their processes and requirements. With intelligent sensors, we can deliver exactly what our customers need. In application centers in Europe, Asia and North America, system solutions are tested and optimized in accordance with customer specifications. All this makes us a reliable supplier and development partner.

Comprehensive services complete our offering: SICK LifeTime Services provide support throughout the machine life cycle and ensure safety and productivity.

For us, that is “Sensor Intelligence.”

## WORLDWIDE PRESENCE:

Contacts and other locations –[www.sick.com](http://www.sick.com)