



Product designation				Enclosed switch disconnecter	
Product type designation				GAZM	
Number of poles	Nr.			3	
Operating voltage type				AC	
Contact characteristics					
IEC Conventional free air thermal current I _{th}	A			160	
Rated insulation voltage U _i IEC/EN	V			1000	
Rated impulse withstand voltage U _{imp}	kV			8	
Operating current I _e					
AC21A		400V	A	160	
		500V	A	160	
		690V	A	160	
AC22A		400V	A	160	
		500V	A	125	
		690V	A	125	
AC23A		400V	A	125	
		500V	A	100	
		690V	A	47	
Power dissipation per pole max	W			12	
Rated operational power AC23A		400V	kW	55	
		690V	kW	45	
Conditional short-circuit current (rms)	kA			50	
Short-circuit protection with fuse	Class/A			gG160	
Making capacity AC23A 400V	A			1250	
Breaking capacity AC23A 400V	A			1000	
Mechanical life	cycles			30000	
Electrical life AC21A	cycles			1500	
Mechanical features					
Operating position	normal allowable			Vertical plan Any	
Terminals	type			Pillar	
	width	mm			12.4
	height	mm			10.4
	screw			M8	
	tool			Metric Allen key 4	
Tightening torque for terminals	min	Nm			5
	max	Nm			6

	min	lbin	45
	max	lbin	54

Conductor section

IEC min	mm ²	4
IEC max	mm ²	70
AWG/kcmil min		12
AWG/kcmil max		1

Ambient conditions

Operating temperature

min	°C	-25
max	°C	+55

Storage temperature

min	°C	-40
max	°C	+70

Max altitude

m	3000
---	------

Resistance & Protection

Frontal IP degree

IP65

Pollution degree

3

Dimensions

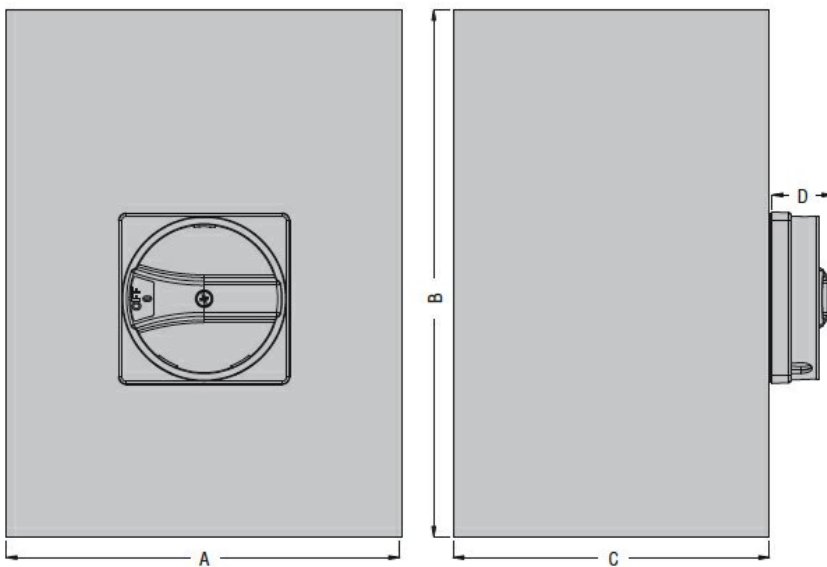

Type	A	B	C	D
GAZM125...GAZM160...	200 (7.87")	300 (11.81")	120 (4.72")	23 (0.90")

Wiring diagrams

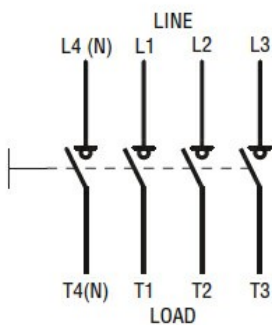

Certifications and compliance

Compliance

IEC/EN 60947-1
IEC/EN 60947-3

ETIM classification

ETIM 8.0

EC000216 -
Switch
disconnecter