



# DAXTVN-1600RA1J0300100

DAX

MAGNETOSTRICTIVE LINEAR ENCODERS

**SICK**  
Sensor Intelligence.



Illustration may differ

### Ordering information

Type	Part no.
DAXTVN-1600RA1J0300100	1134731

Accessories not included with delivery, please order separately.

Delivery without position magnet.

Other models and accessories → [www.sick.com/DAX](http://www.sick.com/DAX)



### Detailed technical data

#### Performance

<b>Linearity</b>	≤ 0.02% F.S. (Minimum 60 μm) <sup>1) 2)</sup>
<b>Repeatability</b>	≤ ± 20 μm
<b>Measured values</b>	Positioning
<b>Measuring range</b>	0 mm ... 1,600 mm
<b>Unusable range</b>	
Null zone	50 mm
Damping zone	63 mm
<b>Magnet type</b>	
Magnet shape	Ring magnet
Configured for number of magnets	1 piece
<b>Magnet travel speed</b>	Any
<b>Measuring frequency (internal)</b>	< 2 ms

<sup>1)</sup> Systematic position measurement deviation according to DIN ISO 1319-1 (value includes all systematic errors or deviations from the actual position value, e.g. repeatability and hysteresis).

<sup>2)</sup> In principle, the size of the measurement deviation is limited by the resolution of the interface.

#### Interfaces

<b>Communication interface</b>	Analog
<b>Communication Interface detail</b>	Voltage
<b>Output signal</b>	0 V ... 10 V
<b>Signals</b>	
Number of signals	2 output signals (one output signal + an inverted second output signal)
Sequence of signals	Signal 1: rising, signal 2: falling
<b>Load resistance</b>	> 10 kΩ

#### Electrical data

<b>Connection type</b>	Male connector, M12, 5-pin
<b>PIN assignment</b>	1=+24 V DC; 2=Signal 1; 3=Power ground; 4=Signal 2; 5=Output signal ground (0 V)

<sup>1)</sup> This product is a standard product and does not constitute a safety component as defined in the Machinery Directive. Calculation based on nominal load of components, average ambient temperature 40°C, frequency of use 8760 h/a. All electronic failures are considered hazardous. For more information, see document no. 8015532.

<b>Male connector coding</b>	A-coded
<b>Supply voltage</b>	24 V DC ( $\pm 20\%$ )
<b>Reverse polarity protection</b>	Up to $-30$ V DC
<b>Residual ripple</b>	$\leq 0.28 V_{pp}$
<b>Dielectric strength</b>	500 V DC, 0 V against housing
<b>Over voltage protection</b>	$\leq 36$ V DC
<b>MTTFd: mean time to dangerous failure</b>	123 years <sup>1)</sup>

<sup>1)</sup> This product is a standard product and does not constitute a safety component as defined in the Machinery Directive. Calculation based on nominal load of components, average ambient temperature 40 °C, frequency of use 8760 h/a. All electronic failures are considered hazardous. For more information, see document no. 8015532.

### Mechanical data

<b>Mechanical design</b>	DAX Threaded	
<b>Thread</b>	Thread shape	M18 x 1.5
	Thread offset	With thread offset
	<b>Material</b>	
	Pressure pipe	Stainless steel 1.4404 (AISI 316L)
	Housing	Aluminum (anodised), zinc, stainless steel, brass
	Flange	Stainless steel 1.4305 (AISI 303)

### Ambient data

<b>EMC</b>	According to EN 61000-6-2 and EN 61000-6-4	
<b>Enclosure rating</b>	IP65 / IP67 <sup>1)</sup>	
<b>Temperature</b>	Operating temperature range	$-40$ °C ... $+85$ °C
	Storage temperature range	$-40$ °C ... $+65$ °C <sup>2)</sup>
	<b>Permissible relative humidity</b>	90 % (Condensation not permitted)
<b>Resistance to shocks</b>	100 g, 6 ms (IEC 60068-2-27)	
<b>Resistance to vibration</b>	15 g / 10...2,000 Hz according to IEC 60068-2-6	
<b>Nominal operating pressure (P<sub>N</sub>)</b>	350 bar	
<b>Max. overload pressure during operation (P<sub>N</sub> x 1.2)</b>	420 bar	
<b>Max. test pressure in cylinder (P<sub>N</sub> x 1.5)</b>	530 bar	

<sup>1)</sup> In correctly assembled mating connector.

<sup>2)</sup> Caused by dry storage of the O-ring in uninstalled state (no coating with oil).

### General notes

<b>Items supplied</b>	Accessories not included with delivery, please order separately. Delivery without position magnet.
-----------------------	---

### Classifications

<b>eCl@ss 5.0</b>	27270705
<b>eCl@ss 5.1.4</b>	27270705
<b>eCl@ss 6.0</b>	27270705

<b>eCl@ss 6.2</b>	27270705
<b>eCl@ss 7.0</b>	27270705
<b>eCl@ss 8.0</b>	27270705
<b>eCl@ss 8.1</b>	27270705
<b>eCl@ss 9.0</b>	27270705
<b>eCl@ss 10.0</b>	27270705
<b>eCl@ss 11.0</b>	27270705
<b>eCl@ss 12.0</b>	27274304
<b>ETIM 5.0</b>	EC002544
<b>ETIM 6.0</b>	EC002544
<b>ETIM 7.0</b>	EC002544
<b>ETIM 8.0</b>	EC002544
<b>UNSPSC 16.0901</b>	41111613

### Dimensional drawing (Dimensions in mm (inch))

DAX Threaded

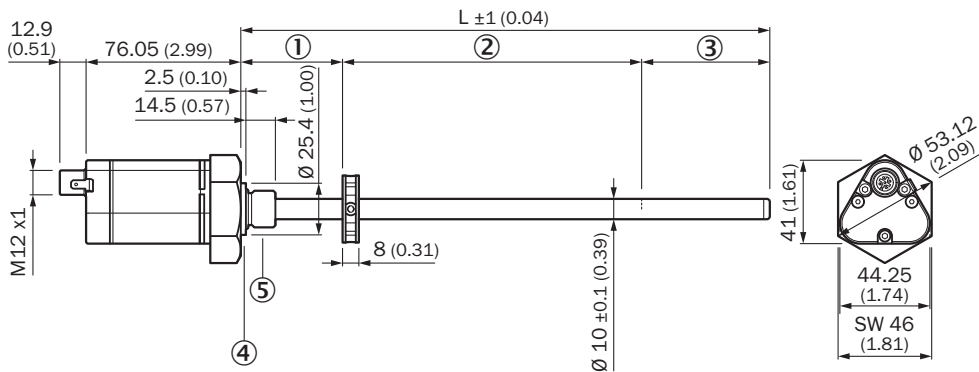

- ① Null zone
- ② Measuring range
- ③ Damping zone
- ④ Offset support surface
- ⑤ M18x1.5 / UNF 3/4"-16

Ring magnet

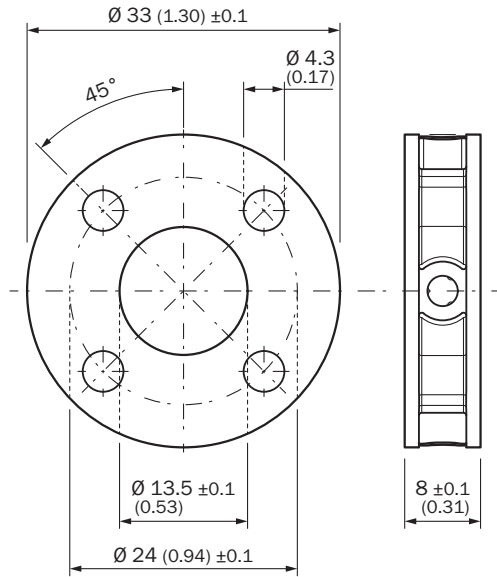

PIN assignment

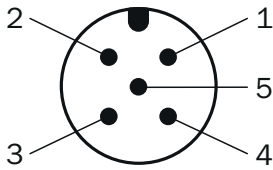





Male connector M12, 5-pin	Signal
1	+24 V DC
2	Signal 1
3	Power Ground
4	Signal 2
5	Output signal ground (0 V)

Recommended accessories

Other models and accessories → [www.sick.com/DAX](http://www.sick.com/DAX)

	Brief description	Type	Part no.
<b>Magnets</b>			
	Position magnet for magnetostriptive linear encoder, Ø 33.0 mm <sup>1</sup> max. axial surface pressure 40 N/mm <sup>2</sup>	MAG-O-330-01	2129167

	Brief description	Type	Part no.
Plug connectors and cables			
	Head A: female connector, M12, 5-pin, straight, A-coded Head B: Flying leads Cable: Sensor/actuator cable, PUR, halogen-free, shielded, 1.5 m	YF2A25-015UB6XLEAX	2095833
	Head A: female connector, M12, 5-pin, straight, A-coded Head B: Flying leads Cable: Sensor/actuator cable, PUR, halogen-free, shielded, 3 m	YF2A25-030UB6XLEAX	2095834
	Head A: female connector, M12, 5-pin, angled, A-coded Head B: Flying leads Cable: Sensor/actuator cable, PUR, halogen-free, shielded, 3 m	YG2A25-030UB6XLEAX	2095791
	Head A: female connector, M12, 5-pin, angled, A-coded Head B: Flying leads Cable: Sensor/actuator cable, PUR, halogen-free, shielded, 5 m	YG2A25-050UB6XLEAX	2095792
	Head A: female connector, M12, 5-pin, angled, A-coded Head B: Flying leads Cable: Sensor/actuator cable, PUR, halogen-free, shielded, 10 m	YG2A25-100UB6XLEAX	2095793
	Head A: female connector, M12, 5-pin, straight Cable: unshielded	DOS-1205-G	6009719
	Head A: male connector, M12, 5-pin, straight Cable: unshielded For field bus technology	STE-1205-G	6022083

## SICK AT A GLANCE

SICK is one of the leading manufacturers of intelligent sensors and sensor solutions for industrial applications. A unique range of products and services creates the perfect basis for controlling processes securely and efficiently, protecting individuals from accidents and preventing damage to the environment.

We have extensive experience in a wide range of industries and understand their processes and requirements. With intelligent sensors, we can deliver exactly what our customers need. In application centers in Europe, Asia and North America, system solutions are tested and optimized in accordance with customer specifications. All this makes us a reliable supplier and development partner.

Comprehensive services complete our offering: SICK LifeTime Services provide support throughout the machine life cycle and ensure safety and productivity.

For us, that is “Sensor Intelligence.”

## WORLDWIDE PRESENCE:

Contacts and other locations –[www.sick.com](http://www.sick.com)