

# Sense Air

  IP20

220-240V, 50/60Hz

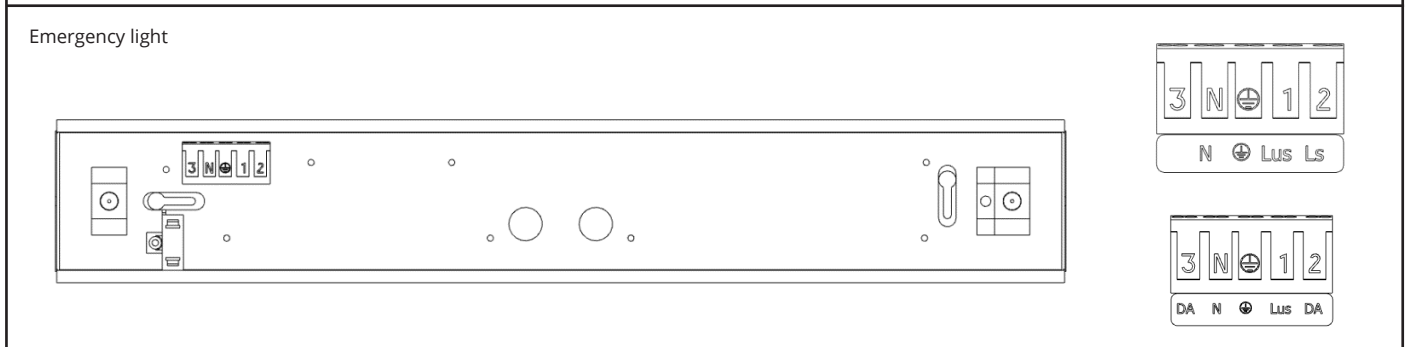
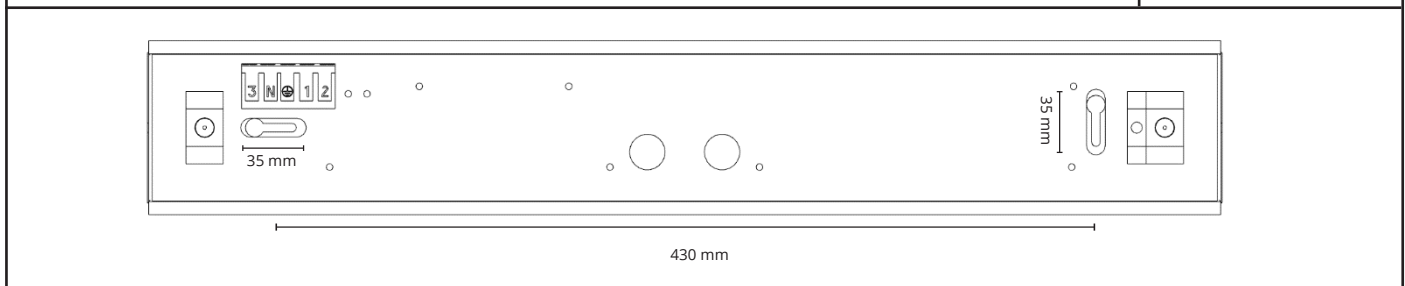
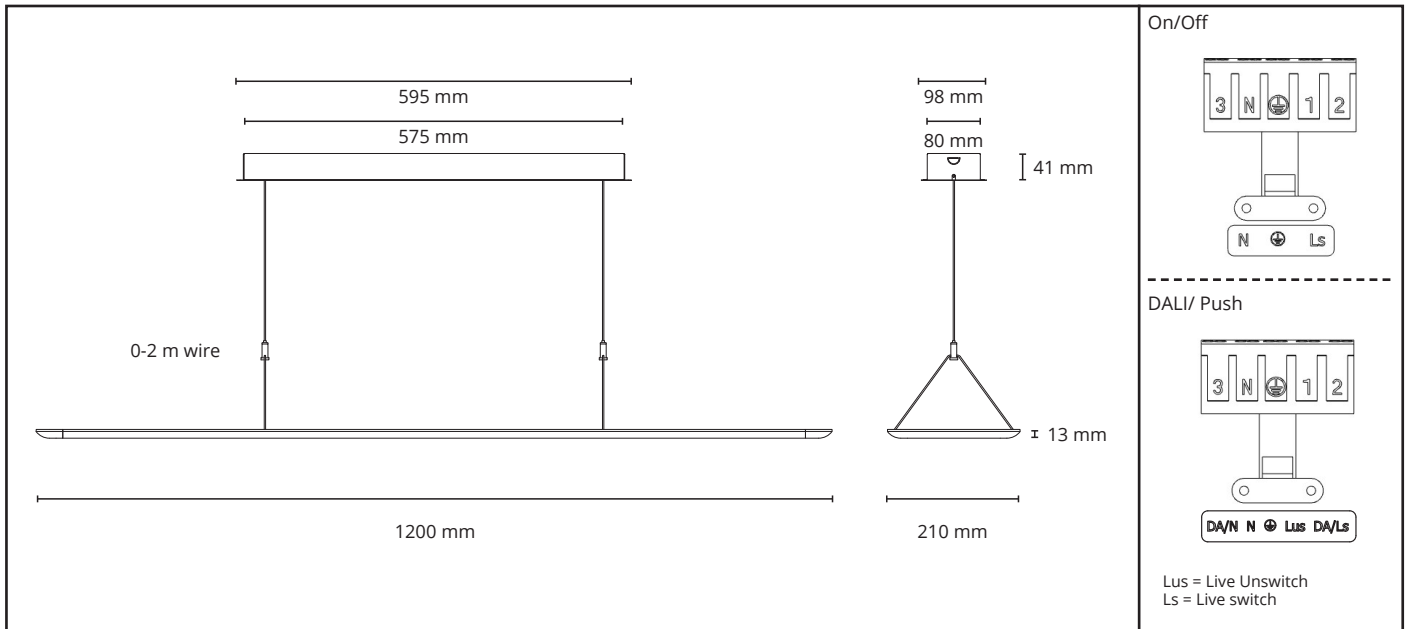

**NO:** Kan kun installeres av en registrert installasjonsvirksomhet.  
**EN:** Only to be installed by an authorized electrician.  
**FR:** Doit être installé par un électricien autorisé.  
**NL:** Mag alleen geïnstalleerd worden door een bevoegde elektricien.  
**DE:** Dieses Produkt darf nur durch autorisiertes Personal (z. B. Elektro-Installateur) angeschlossen und in Betrieb genommen werden.  
**FI:** Asentaa saa vain valtuutettu sähköasentaja



**NO:** Skru av strømmen før montering.  
**EN:** Turn off power before installing.  
**FR:** Couper le courant avant l'installation.  
**NL:** Stroom uitschakelen voor u het toestel installeert.  
**DE:** Vor Installationsarbeiten den Strom abschalten.  
**FI:** Sammuta virta ennen kytkemistä

**NORWAY**  
SG Armaturen AS

Skytterheia 25  
N-4790 Lillesand

Tel: +47 37 50 03 00  
firmapost@sg-as.no  
www.sg-as.no

**SWEDEN**

SG Armaturen AB  
Tel: +46 31 81 71 10  
info@sg-ab.se  
www.sg-ab.se

**FINLAND**

SG Armaturen Oy  
info@sg-oy.fi  
www.sg-oy.fi

**DENMARK**

SG Armaturen A/S  
Tel: +45 70 70 72 13  
info@sg-as.dk  
www.sg-as.dk

**UNITED KINGDOM**

SG Lighting LTD  
Tel: +47 37 50 03 00  
info@sglighting.co.uk  
www.sglighting.co.uk

**FRANCE**

SG Lighting SA/NV  
Tel: +33(0) 4 94 93 00 00  
info.france@sglighting.fr  
www.sglighting.net

**BENELUX**

SG Lighting SA/NV  
Tel: +32(0) 15 20 72 71  
info.benelux@sglighting.net  
www.sglighting.net

**GERMANY**

SG Leuchten GmbH  
Tel: +49 40 23 99 44 59  
info@sg-leuchten.de  
www.sg-leuchten.de

**INTERNATIONAL**

SG Lighting Co Ltd.  
Tel: +86 769 88 49 20 88  
cindy@sgdgc.com  
www.sg-as.com

Alt. A

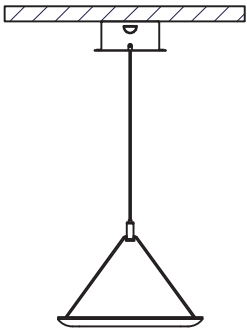

Alt. B

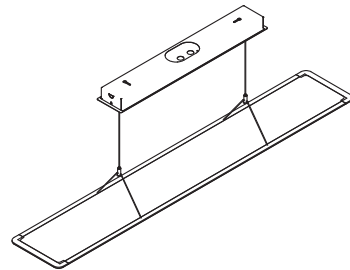
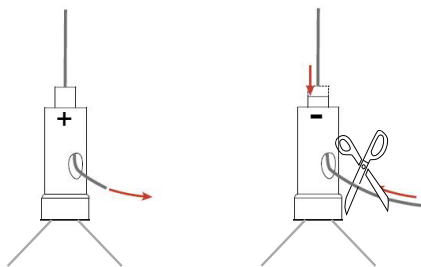
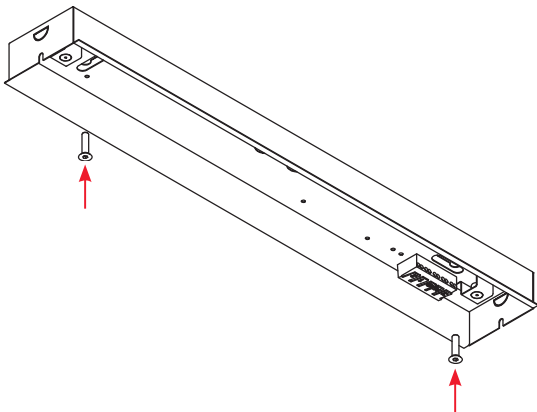
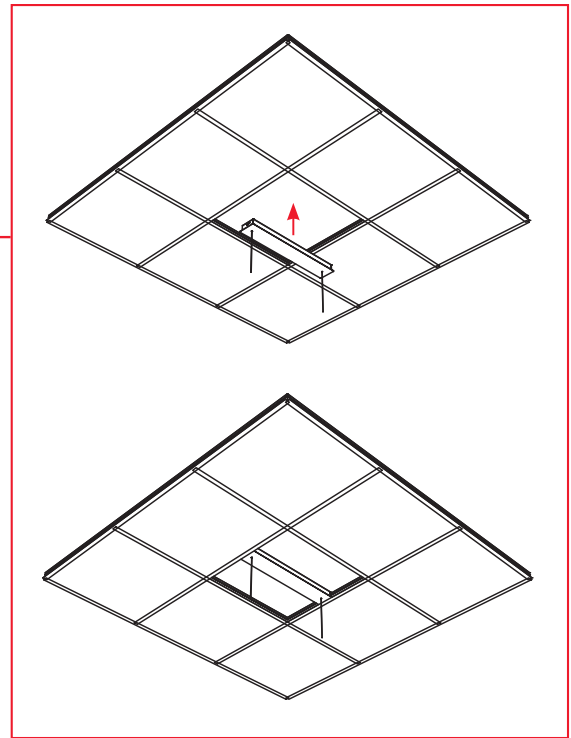
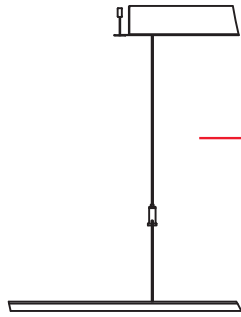

Dipswitch

	ON	ON	ON	Standard
	1 2	1 2	1 2	1 2
<b>mA</b>	800	900	975	1050
<b>lm</b>	76%	86%	93%	100%

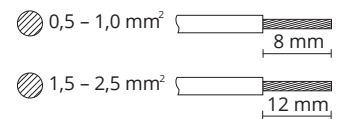
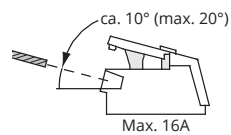

# ELP Emergency



3h: LDM90HOST + B084

1h: LDM90HOST/1HR + B068

220-240V, 50/60Hz, Self-test



Installation/Replacement of battery

Date Sign.

dd.mm.yy *Signature*

Date Sign.

24h

27h

100%

or:

MAX 2 MONTHS

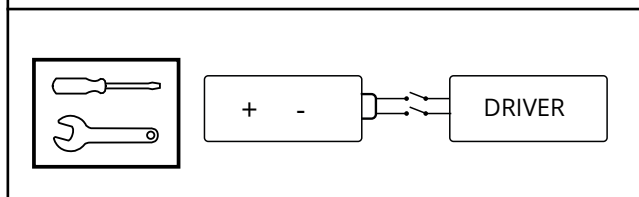
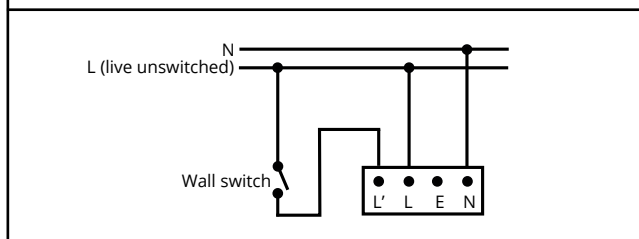

4-5 years Please also consider local requirements.

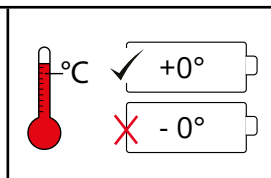

		System OK/main operation mode
	2 sec	Duration test/comissioning
	0,5 sec	Function test
		LED luminaire fault
	2 sec	Battery/test failure
	0,5 sec	Battery charging failure

Rev: 29.05.2019

**NORWAY** SG Armaturen AS  
Tlf:+47 37 50 03 00  
firmapost@sg-as.no  
www.sg-as.no

**SWEDEN** SG Armaturen AB  
Tel: +46 31 81 71 10  
info@sg-ab.se  
www.sg-ab.se

**FRANCE** SG Lighting SA/NV  
Tel: +33(0) 4 94 93 00 00  
info.france@sglighting.fr  
www.sglighting.net

**GERMANY** SG Leuchten GmbH  
Tel: +49 40 23 99 44 59  
info@sg-leuchten.de  
www.sg-leuchten.de

**DENMARK** SG Armaturen A/S  
Tel: +45 70 70 72 13  
info@sg-as.dk  
www.sg-as.dk

**FINLAND** SG Armaturen Oy  
info@sg-oy.fi  
www.sg-oy.fi

**BENELUX** SG Lighting SA/NV  
Tel: +32(0) 15 20 72 71  
info.benelux@sglighting.net  
www.sglighting.net

**INTERNATIONAL** SG Lighting Co Ltd.  
Tel: +86 769 88 49 20 88  
cindy@sgdgc.com  
www.sg-as.com

