

1SNA235563R0000 ✓ ACTIVE

ENTRELEC | ENTRELEC HTP600

TE Internal #: 1SNA235563R0000

Terminal Block & Strip Marking Accessories, Marking Strip, Blank
Mark Details, Transparent, 5 – 158 °F [-15 – 70 °C], UL 94V-0,
ENTRELEC HTP600

[View on TE.com >](#)



Connectors > Terminal Blocks & Strips > Terminal Block & Strip Accessories > Terminal Block & Strip Marking Accessories

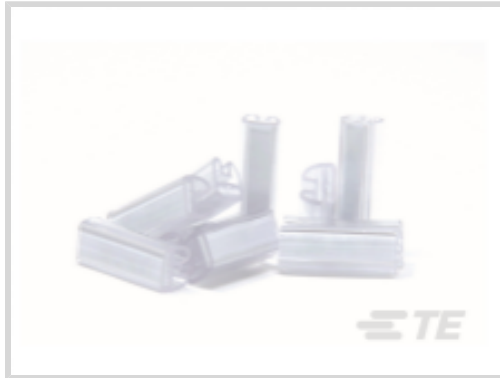

Marking Product Type: **Marking Strip**

Pre-Printed Mark Details: **Blank**

Primary Product Color: **Transparent**

Operating Temperature Range: **-15 – 70 °C [5 – 158 °F]**

UL Flammability Rating: **UL 94V-0**

Features

Product Type Features

Marking Product Type	Marking Strip
----------------------	---------------

Configuration Features

Pre-Printed Mark Details	Blank
--------------------------	-------

Body Features

Primary Product Color	Transparent
-----------------------	-------------

Usage Conditions

Operating Temperature Range	-15 – 70 °C[5 – 158 °F]
-----------------------------	-------------------------

Industry Standards

UL Flammability Rating	UL 94V-0
------------------------	----------

Product Compliance

[For compliance documentation, visit the product page on TE.com>](#)

EU RoHS Directive 2011/65/EU	Compliant
EU ELV Directive 2000/53/EC	Compliant
China RoHS 2 Directive MIIT Order No 32, 2016	No Restricted Materials Above Threshold
EU REACH Regulation (EC) No. 1907/2006	Current ECHA Candidate List: JUNE 2022 (224)



Candidate List Declared Against: JUNE 2022 (224)
Does not contain REACH SVHC

Halogen Content	Not Low Halogen - contains Br or Cl > 900 ppm.
Solder Process Capability	Not applicable for solder process capability

Product Compliance Disclaimer

This information is provided based on reasonable inquiry of our suppliers and represents our current actual knowledge based on the information they provided. This information is subject to change. The part numbers that TE has identified as EU RoHS compliant have a maximum concentration of 0.1% by weight in homogenous materials for lead, hexavalent chromium, mercury, PBB, PBDE, DBP, BBP, DEHP, DIBP, and 0.01% for cadmium, or qualify for an exemption to these limits as defined in the Annexes of Directive 2011/65/EU (RoHS2). Finished electrical and electronic equipment products will be CE marked as required by Directive 2011/65/EU. Components may not be CE marked. Additionally, the part numbers that TE has identified as EU ELV compliant have a maximum concentration of 0.1% by weight in homogenous materials for lead, hexavalent chromium, and mercury, and 0.01% for cadmium, or qualify for an exemption to these limits as defined in the Annexes of Directive 2000/53/EC (ELV). Regarding the REACH Regulation, the information TE provides on SVHC in articles for this part number is based on the latest European Chemicals Agency (ECHA) 'Guidance on requirements for substances in articles' posted at this URL: <https://echa.europa.eu/guidance-documents/guidance-on-reach>

Compatible Parts

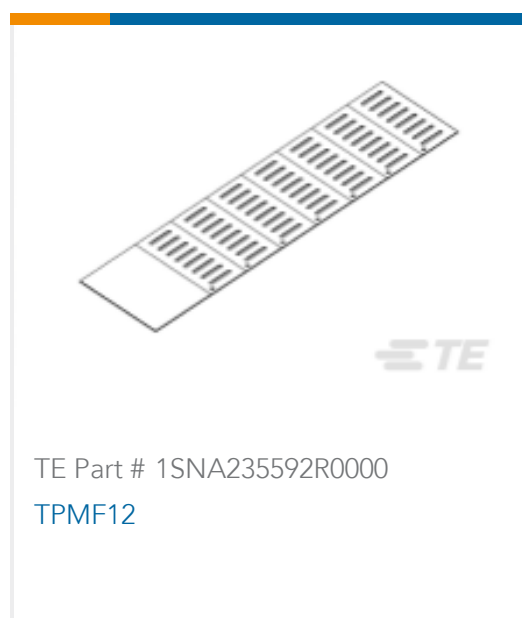

Also in the Series | ENTRELEC HTP600

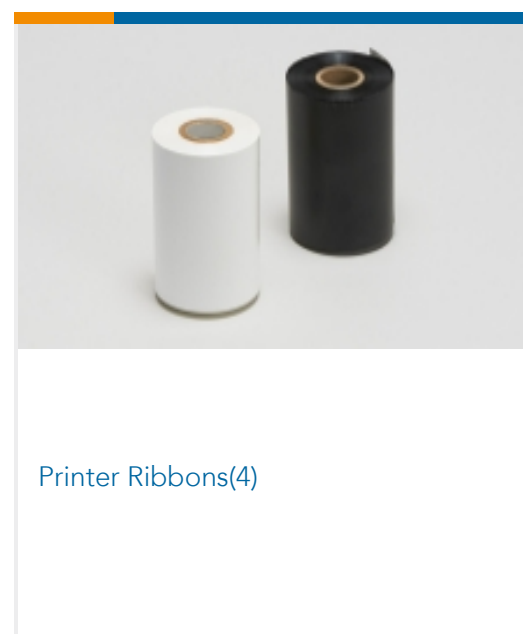
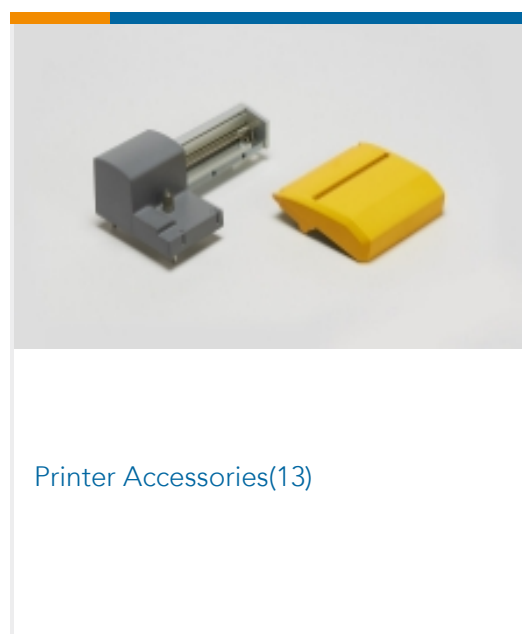

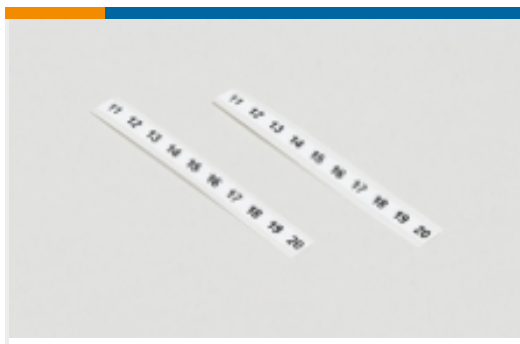

Terminal Block & Strip Marking Accessories(115)

Customers Also Bought



TE Part #1-222246-0
CONTACT,PLUG,COML BNC PLATED



TE Part #293722-1
NECTOR M PIN HSG FREE HANGING 7P CODE A



TE Part #2836167-1
OCEAN_2.0_Applicator-S-045F



TE Part #2844982-1
CCII TYPE VI MLTIMATE PIN/SKT 22-18 ASSY



TE Part #589597-000
55A0831-24-9/93/96CS2275

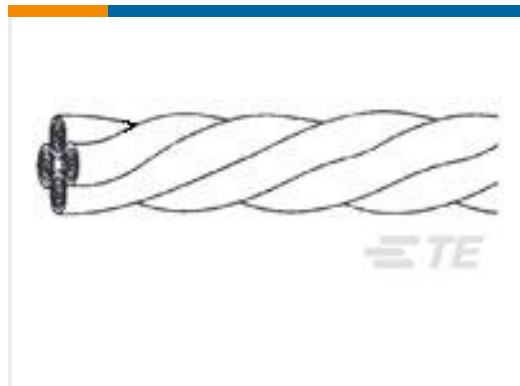

TE Part #924309-000
55PC0141-24-2/5/6/9

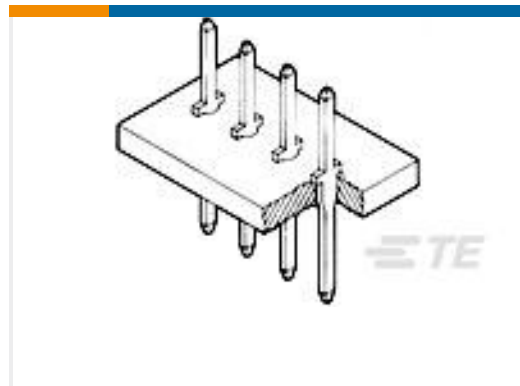

TE Part #86147-8
MOD I POST PLTD 30 AU



TE Part #9-1633933-2
ANVIL, COMBINATION



TE Part #227079-9
COMM. BNC-PLUG



TE Part #YDTS20F21-16AC0000
SQUARE FLANGE RECEPTACLE

Documents

Product Drawings

[PMF122](#)

English

Datasheets & Catalog Pages

[Catalogue - HTP600 Thermal Transfer Printer and Markers](#)

English

[Datasheet - Htp600](#)

French



[Datasheet - Htp600 Thermal-Transfer-Printer-Marker](#)

English

[Datasheet - Htp600 Thermal-Transfer-Printer-Marker](#)

French