



Product designation				Power contactor
Product type designation				BF94
Contact characteristics				
Number of poles	Nr.			3
Rated insulation voltage U _i IEC/EN	V			1000
Rated impulse withstand voltage U _{imp}	kV			8
Operational frequency	min	Hz	25	
	max	Hz	400	
IEC Conventional free air thermal current I _{th}	A			115
Operational current I _e	AC-1 (≤40°C)	A	115	
	AC-1 (≤55°C)	A	95	
	AC-1 (≤70°C)	A	80	
	AC-3 (≤440V ≤55°C)	A	95	
	AC-4 (400V)	A	45	
Rated operational power AC-3 (T≤55°C)	230V	kW	30	
	400V	kW	55	
	415V	kW	55	
	440V	kW	55	
	500V	kW	55	
	690V	kW	55	
	1000V	kW	37	
Rated operational current AC-3 (T≤55°C)	230V	A	94	
	400V	A	94	
	415V	A	94	
	440V	A	94	
	500V	A	78	
	690V	A	57	
	1000V	A	28	
IEC max current I _e in DC1 with L/R ≤ 1ms with 1 poles in series	≤24V	A	77	
	48V	A	66	
	75V	A	66	
	110V	A	8	
	220V	A	–	
IEC max current I _e in DC1 with L/R ≤ 1ms with 2 poles in series	≤24V	A	110	
	48V	A	110	
	75V	A	110	
	110V	A	90	
	220V	A	9	
IEC max current I _e in DC1 with L/R ≤ 1ms with 3 poles in series				

	≤24V	A	110
	48V	A	110
	75V	A	110
	110V	A	93
	220V	A	95
<hr/>			
IEC max current I _e in DC1 with L/R ≤ 1ms with 4 poles in series	≤24V	A	115
	48V	A	115
	75V	A	115
	110V	A	110
	220V	A	115
<hr/>			
IEC max current I _e in DC3-DC5 with L/R ≤ 15ms with 1 poles in series	≤24V	A	45
	48V	A	33
	75V	A	33
	110V	A	3
	220V	A	–
<hr/>			
IEC max current I _e in DC3-DC5 with L/R ≤ 15ms with 2 poles in series	≤24V	A	65
	48V	A	55
	75V	A	55
	110V	A	43
	220V	A	5
<hr/>			
IEC max current I _e in DC3-DC5 with L/R ≤ 15ms with 3 poles in series	≤24V	A	86
	48V	A	75
	75V	A	75
	110V	A	64
	220V	A	64
<hr/>			
IEC max current I _e in DC3-DC5 with L/R ≤ 15ms with 4 poles in series	≤24V	A	96
	48V	A	95
	75V	A	95
	110V	A	80
	220V	A	80
<hr/>			
Short-time allowable current for 10s (IEC/EN60947-1)		A	640
<hr/>			
Protection fuse	gG (IEC)	A	125
	aM (IEC)	A	100
<hr/>			
Making capacity (RMS value)		A	950
<hr/>			
Breaking capacity at voltage	440V	A	640
	500V	A	625
	690V	A	456
<hr/>			
Resistance per pole (average value)		mΩ	0.6
<hr/>			
Power dissipation per pole (average value)	I _{th}	W	7.9
	AC-3	W	5.4
<hr/>			
Tightening torque for terminals	min	Nm	4
	max	Nm	5
	min	I _{bin}	3
	max	I _{bin}	3.7

Tightening torque for coil terminal

min	Nm	0.8
max	Nm	1
min	Ibin	0.59
max	Ibin	0.74

Max number of wires simultaneously connectable

Nr. 2

Conductor section

Flexible w/o lug conductor section

min	mm ²	1.5
max	mm ²	35

Power terminal protection according to IEC/EN 60529

IP20

Mechanical features

Operating position

normal allowable Vertical plan
±30°

Fixing

Screw / DIN rail
35mm

Weight

g 1

Operations

Mechanical life

cycles 15000000

Electrical life

cycles 1100000

Safety related data

Mirror contacts according to IEC/EN 609474-4-1

YES

EMC compatibility

yes

AC coil operating

Rated AC voltage at 50/60Hz

V 110

AC operating voltage

of 50/60Hz coil powered at 50Hz
pick-up

min	%Us	80
max	%Us	110

drop-out

min	%Us	20
max	%Us	55

of 50/60Hz coil powered at 60Hz
pick-up

min	%Us	85
max	%Us	110

drop-out

min	%Us	20
max	%Us	55

of 60Hz coil powered at 60Hz
pick-up

min	%Us	80
max	%Us	110

drop-out

min	%Us	20
max	%Us	55

AC average coil consumption at 20°C

of 50/60Hz coil powered at 50Hz

in-rush	VA	210
holding	VA	15

of 50/60Hz coil powered at 60Hz

in-rush	VA	195
---------	----	-----

	holding	VA	13
of 60Hz coil powered at 60Hz			
	in-rush	VA	210
	holding	VA	15
Dissipation at holding ≤20°C 50Hz		W	5
Max cycles frequency			
Mechanical operation		cycles/h	3600
Operating times			
Average time for Us control			
in AC			
	Closing NO	min	ms 12
		max	ms 28
	Opening NO	min	ms 8
		max	ms 22
in DC			
	Closing NO	min	ms 40
		max	ms 85
	Opening NO	min	ms 20
		max	ms 55
UL technical data			
Full-load current (FLA) for three-phase AC motor			
	at 480V	A	77
	at 600V	A	77
Yielded mechanical performance			
for three-phase AC motor			
	200/208V	HP	25
	220/230V	HP	30
	460/480V	HP	60
	575/600V	HP	75
General USE			
Contactor			
	AC current	A	115
Short-circuit protection fuse, 600V			
High fault			
	Short circuit current	kA	100
	Fuse rating	A	200
	Fuse class		J
Standard fault			
	Short circuit current	kA	10
	Fuse rating	A	200
	Fuse class		RK5
Ambient conditions			
Temperature			
Operating temperature			
	min	°C	-50
	max	°C	70
Storage temperature			
	min	°C	-60
	max	°C	80
Max altitude		m	3000

Dimensions

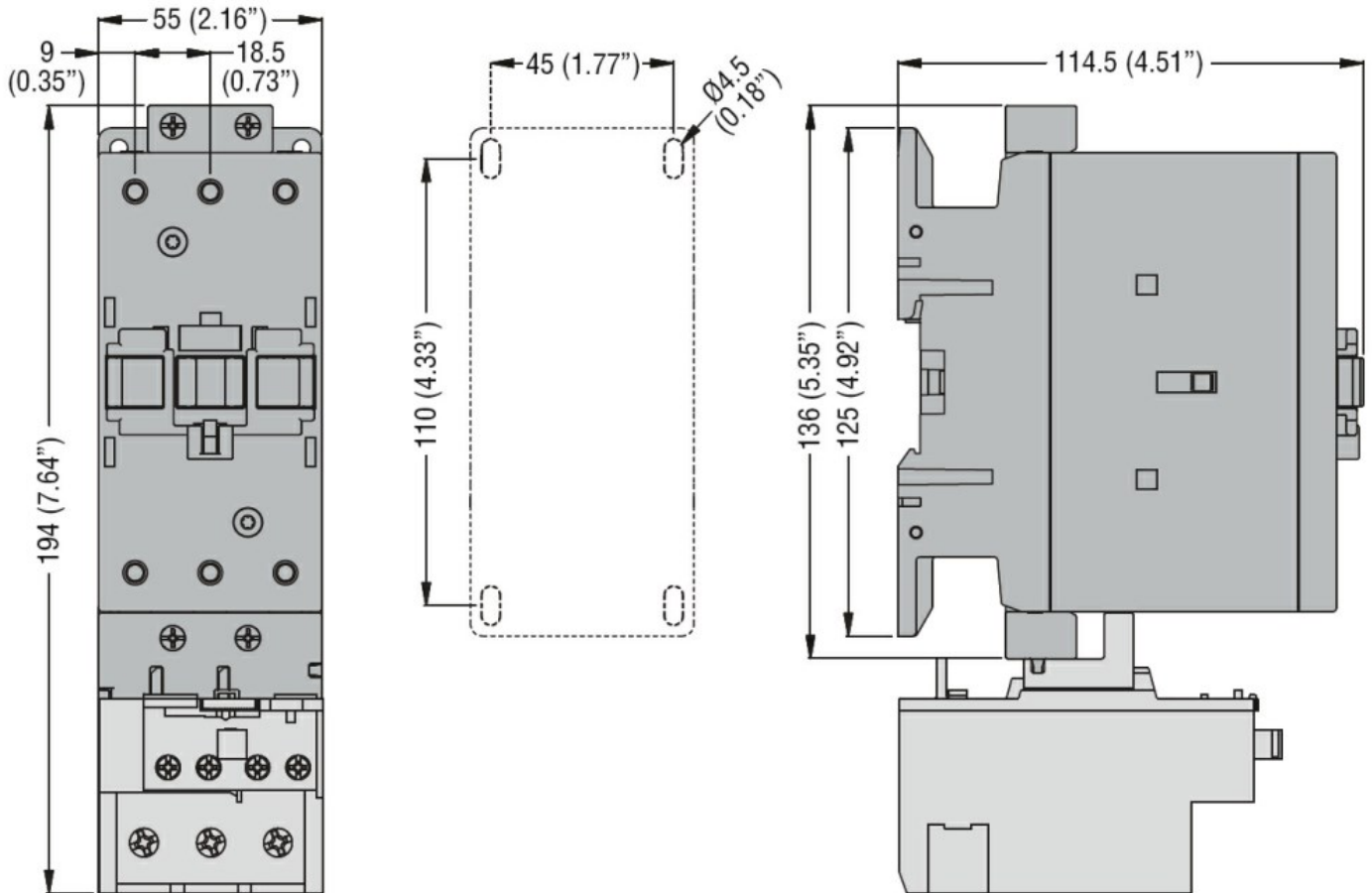

Wiring diagrams

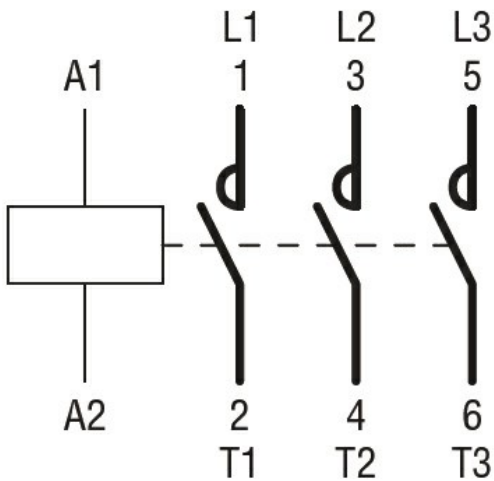

Certifications and compliance

Compliance

- CSA C22.2 n° 60947-1
- CSA C22.2 n° 60947-4-1
- IEC/EN/BS 60947-1
- IEC/EN/BS 60947-4-1
- UL 60947-1
- UL 60947-4-1

Certificates

CCC

cULus

EAC

ETIM classification

ETIM 8.0

EC000066 -
Power contactor,
AC switching