

Part number
CGT 10



PE terminal adapter, wire terminal adapter 10 mm² (AWG 8)



Product description	
Product type	PE terminal adapter
Specification	For MIXO inserts Nickel-plated
Technical data	
Wire cross-section	10,00 mm ²
AWG size	8
Further technical details	
Weight	5,00 g

Material properties	
RoHs conformity	Compliant with exemption 6(c): copper alloy containing up to 4% lead by weight
China RoHs - EFUP	50
REACH SVHC substances	Yes Lead
SCIP number	5e01cfb1-f424-4348-b68e-90952292bfef
General ordering information	
EAN13 code	8015747262637
eCl@ss 8.1	27449290
ETIM 7.0	EC000796
Packaging Information	
Sub-packaging length	50,00 mm
Sub-packaging height	44,00 mm
Sub-packaging width	50,00 mm
Sub-packaging weight	0,10 kg
Sub-packaging volume	0,11 dm ³
Sub-packaging description	Plastic box
Sub-packaging quantity	20 Pcs
Sub-packaging EAN barcode	8015747262668

Part number

CGT 10



Catalogue drawings

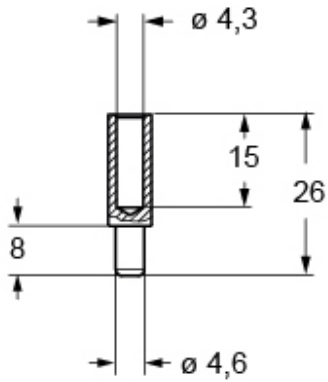

Notes

Dimensions shown in mm are not binding and may be changed without notice.

California Proposition 65 Information



WARNING

This product can expose you to lead and its compounds, known to the State of California to cause cancer and/or reproductive toxicity. For more information go to www.P65Warnings.ca.gov.