



LC1DT●●A6●●

A

(1)	150 5.91	LAD N, LAD C
(2)	163 6.42	LAD6K10
(3)	171 6.73	LAD T, LAD R, LAD S2
(4)	12,5 0.49	LAD8N

B

Rail 35 mm → EN 50022, NFC 63015

15 0.6 15 0.6

7.5 0.3

Click!

C

37,5 1.48

128 5.04

18,7 0.74

3 x M4 x 20
3 x (# 8 x 32) x 0.79

1 N.m
9 lb-in

Click!

⚠ ⚠ DANGER / DANGER / PELIGRO / GEFAHR / PERICOLO / PERIGO / 危险 / ОПАСНОСТЬ			
<p>HAZARD OF ELECTRIC SHOCK, EXPLOSION, OR ARC FLASH Disconnect all power before servicing equipment. Failure to follow these instructions will result in death or serious injury.</p>	<p>RISQUE D'ÉLECTROCUTION, D'EXPLOSION OU D'ARC ELECTRIQUE Coupez toutes les alimentations avant de travailler sur cet appareil. Le non-respect de ces instructions provoquera la mort ou des blessures graves.</p>	<p>PELIGRO DE DESCARGA ELÉCTRICA, EXPLOSIÓN O ARCO ELÉCTRICO Desconecte todas las alimentaciones antes de manipular el producto. Si no se siguen estas instrucciones provocará lesiones graves o incluso la muerte.</p>	<p>GEFAHR VON ELEKTRISCHEM SCHLAG, EXPLOSION ODER LICHTBOGEN Vor dem Arbeiten am Gerät alle Spannungsversorgungen abschalten. Die Nichtbeachtung dieser Anweisungen führt zu Tod oder schweren Körperverletzung.</p>
<p>RISCHIO DI SCARICA ELETTRICA, ESPLOSIONE O ARCO ELETTRICO Scollegare l'apparecchio da tutti i circuiti di alimentazione prima di qualsiasi intervento. Il mancato rispetto di queste istruzioni provocherà morte o gravi infortuni.</p>	<p>RISCO DE ELECTROCUSSÃO, DE EXPLOSIÃO, OU DE ARCO ELÉCTRICO Desconecte todas as alimentações antes de manipular o produto. A não observância destas instruções resultará em morte, ou ferimentos graves.</p>	<p>电击、爆炸或电弧闪光危险 在此电力设备上工作时， 请先切断所有电源 不遵循上述说明将导致人员伤亡。</p>	<p>Опасность поражением электрическим током, опасность взрыва или вспышки дуги. Перед обслуживанием или ремонтом убедитесь, что питание отключено. Несоблюдение этих инструкций приведет к смерти или серьезной травме.</p>

D

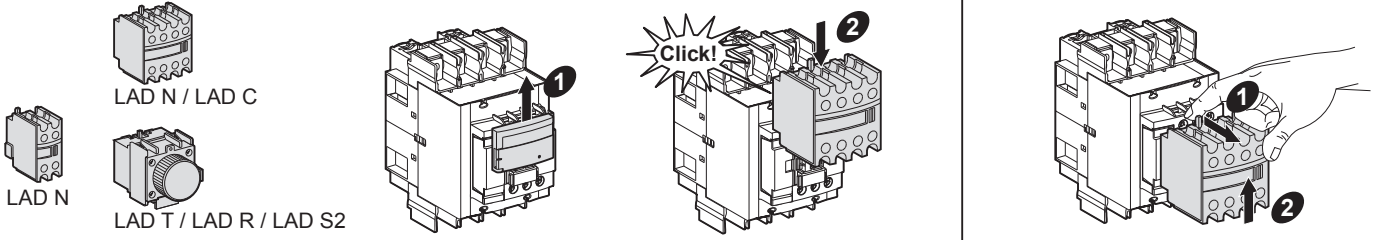

E

~~LC1D●●A●7~~ ~, AC/DC
~~LC1D●●A●D~~ ---

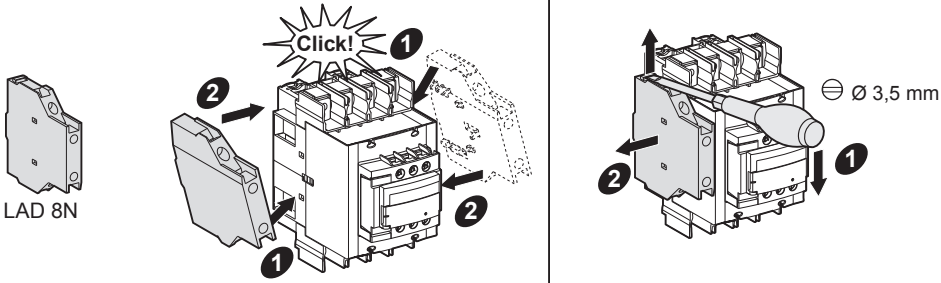

F

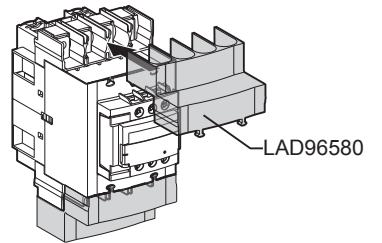

G

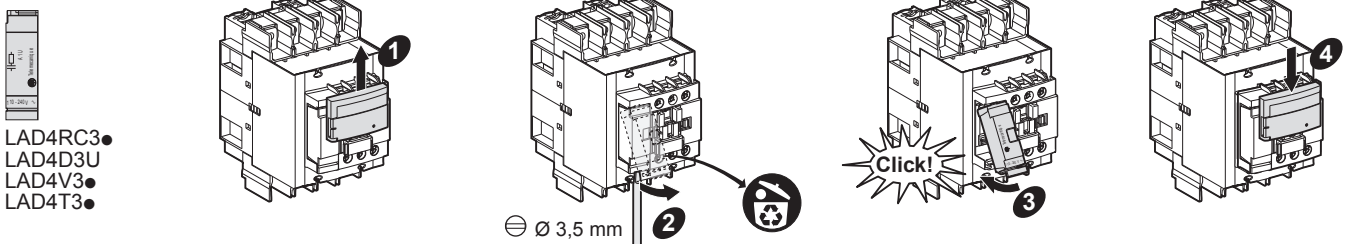

H

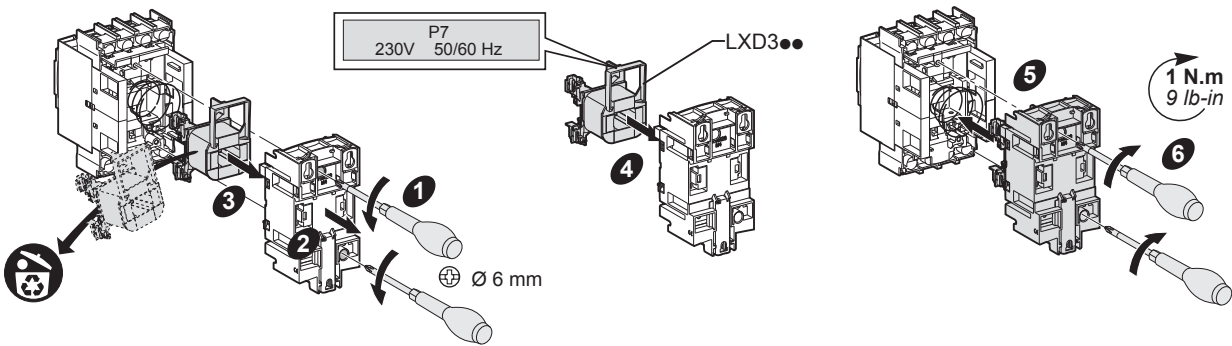

I

LC1DT●●A6

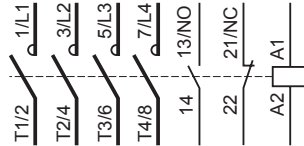
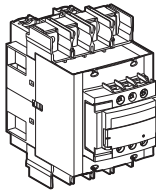

J

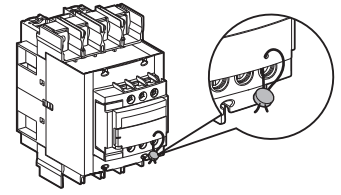

K

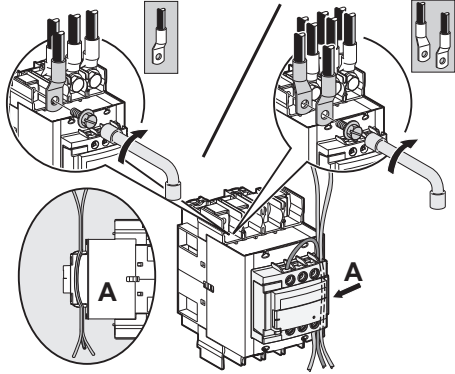

LC1DT●●A6	mm		in		M6 c	10
	e	L	L'	D		
	≤ 6	≤ 13,5	≤ 16,5	> 6	6 N.m 54 lb-in	10
		≤ 0.24	≤ 0.53	≤ 0.24		
		≤ 0.40	≤ 0.65			

LC1DT●●A6	mm		in		M3,5 c	PH 2
	10 mm	1...2,5 mm ²	0.4 in.	AWG 16...12		
					1,7 N.m 15 lb-in	

AC/DC:
 ● use of this product in EMC environment B may require mitigation measures to avoid unwanted disturbance
 ● full open AC at 10%Us.

3P AC TeSys D contactors (LC1D40A->LC1D80A) are grade 2 according to GB 21518. Maximum power consumption lower than 36.6 VA.
 根据GB 21518标准, 三相 TeSys D Everlink系列交流接触器 (LC1D40A->LC1D80A) 能效等级为2级, 产品最大吸持功率低于36.6 VA
 3-фазные контакторы переменного тока TeSys D (LC1D40A->LC1D80A) относятся к категории 2 согласно GB 21518.
 Максимальная потребляемая мощность ниже 36,6 ВА.

Refer to information on device label when ordering replacement parts.	En cas de substitution, vérifier les caractéristiques électriques sur l'étiquette du produit.	En caso de reemplazo, verificar las características eléctricas en la etiqueta del producto.	For Ersatz elektrische Leistungstaden auf dem Typenschild überprüfen.
In caso di sostituzione verificare le caratteristiche elettriche riportate sull'etichetta.	Em caso de substituição verificar as características eléctricas na etiqueta do produto.	进行更换时, 产品标牌上的电气特性需要检查核对	В случае замены электрических компонентов должна быть проверена маркировка продукта

i

The product's manufacture date is coded PPYYWWD, where: ● PP: plant code ● YY: year of manufacture ● WW: week of manufacture ● D: weekday of manufacture (Monday = 1)	La date de fabrication du produit est codée PPYYWWD, avec : ● PP : code usine ● YY : année de fabrication ● WW : semaine de fabrication ● D : jour de fabrication dans la semaine (lundi = 1)	La fecha de fabricación del producto está codificada PPYYWWD, donde: ● PP: código de la planta ● YY: año de fabricación ● WW: semana de fabricación ● D: día de la semana de fabricación (lunes = 1)	Das Herstellungsdatum des Produkts ist folgendermaßen codiert: PPYYWWD. Wobei: ● PP: Werkscode ● YY: Herstellungsjahr ● WW: Herstellungswoche ● D: Herstellungstag (Montag = 1)
La data di fabbricazione del prodotto è indicata con il codice PPYYWWD, dove: ● PP: codice stabilimento ● YY: anno di fabbricazione ● WW: settimana di fabbricazione ● D: giorno della settimana in cui il prodotto è stato fabbricato (lunedì = 1)	A data de fabrico do produto está sob a forma de código PPYYWWD, onde: ● PP: código da fábrica ● YY: ano de fabrico ● WW: semana de fabrico ● D: dia da semana de fabrico (Segunda-feira = 1)	Дата производства продукта закодирована в формате PPYYWWD, где: ● PP: код завода ● YY: год производства ● WW: неделя производства ● (D: день недели, когда был произведен продукт (понедельник = 1))	产品制造日期采用如下代码PPYYWWD, 其中: ● PP: 工厂代码 ● YY: 制造年份 ● WW: 第几周制造 ● D: 星期几制造 (星期一 = 1)

Schneider Electric Industries SAS

35, rue Joseph Monier
CS 30323
F - 92506 Rueil Malmaison Cedex
www.schneider-electric.com

**Уполномоченный поставщик в РФ:
АО «Шнейдер Электрик»**

Адрес:
127018, г. Москва, ул. Двинцев, д.12, корп.1,
тел. +7 (495)777 99 88,
факс: +7 (495)777 99 94, 8-800-200-6446
www.schneider-electric.ru

