

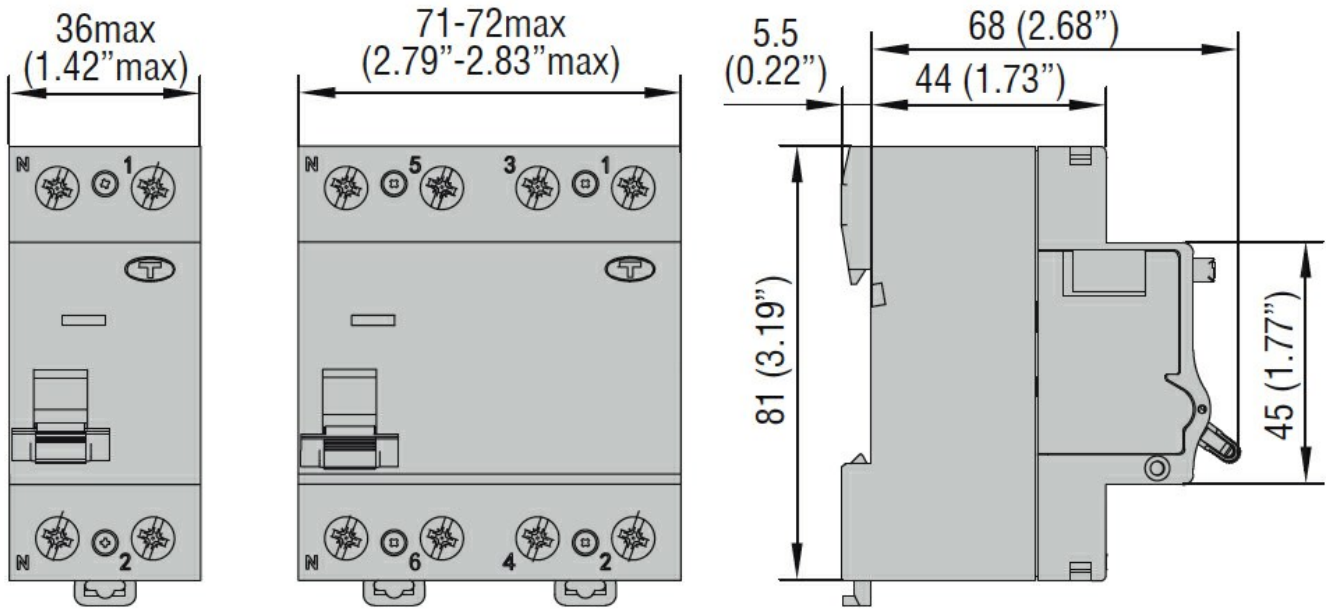

Product designation	Residual current circuit breakers (RCCB)			
Product type designation	P1RD			
Number of poles	4P			
Number of DIN modules	4			
Compliance	IEC			
Electrical features				
Rated insulation voltage U_i IEC/EN	V	400		
Rated impulse withstand voltage U_{imp}	kV	4		
Rated operational voltage AC (IEC)	VAC	230/400		
Rated frequency	Hz	50/60		
Rated current (I_n)	A	40		
Residual operation characteristic	AC			
Rated residual current	mA	30		
Short circuit rating (IEC)	kA	10		
Electrical life	cycles	10000		
Ambient conditions				
Operating temperature	min	°C	-35	
	max	°C	+70	
Storage temperature	min	°C	-40	
	max	°C	+80	
Max altitude	m	2000		
Mechanical features				
Operating position	normal		Vertical plan	
			35mm DIN rail	
Fixing	35mm DIN rail			
Tightening torque for terminals	max	Nm	2	
	max	lbin	15	
Terminals tool	Pz 2			
Conductor section	IEC	min	mm ²	2.5
		max	mm ²	35
	AWG/Kcmil	min	14	
		max	2	
Mechanical life	cycles	20000		
Weight	g	326		
Frontal IP degree	IP20			
Pollution degree	2			
Dimensions				

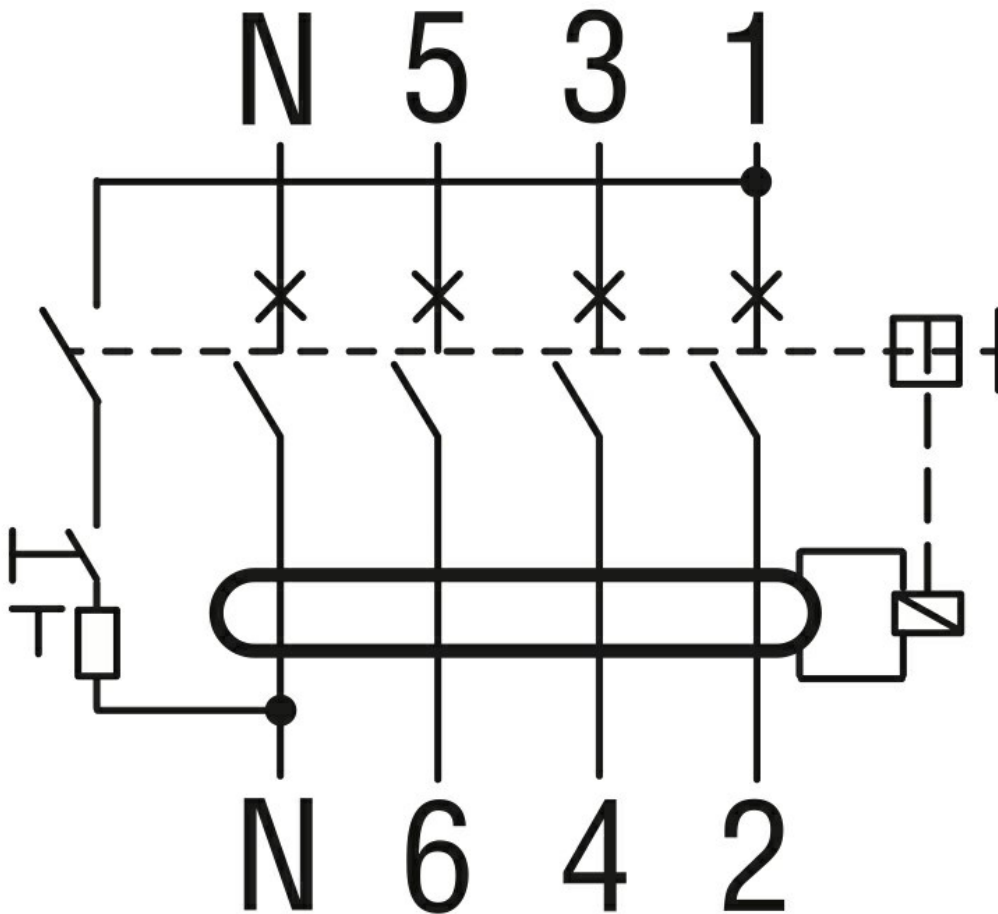

Wiring diagrams



Certifications and compliance

Compliance

IEC/EN/BS 61008-1

Certifications

EAC
TÜV-SUD

ETIM classification

ETIM 8.0

EC000003 -
Residual current
circuit breaker
(RCCB)