

OD5-30T05

OD Precision

DISPLACEMENT MEASUREMENT SENSORS

SICK
Sensor Intelligence.



Ordering information

Type	Part no.
OD5-30T05	6035977

Other models and accessories → www.sick.com/OD_Precision



Detailed technical data

Features

System part	Sensor head
--------------------	-------------

Mechanics/electronics

Supply voltage V_s	DC 12 V ... 24 V ¹⁾
Warm-up time	≤ 5 min
Housing material	Metal (Aluminum)
Window material	Glass
Connection type	0.5 m cable with connector ²⁾
Indication	LEDs, 4" color display on optional evaluation unit
Weight	250 g ³⁾
Dimensions (W x H x D)	29 mm x 78 mm x 75 mm
Enclosure rating	IP67
Protection class	III

¹⁾ DC 12 V (-5 %) ... DC 24 V (+10 %).

²⁾ Can be extended to up to 50 m with extension cable.

³⁾ Includes 0.5 m cable.

Safety-related parameters

MTTF_D	101 years
DC_{avg}	0%

Performance

Measurement range min ... max:	25 mm ... 35 mm ^{1) 2)}
Target	Natural objects
Repeatability	0.2 μm ³⁾
Linearity	Diffuse ± 8 μm ³⁾

¹⁾ 6 % ... 90 % remission; at default settings.

²⁾ If there are reflections, the measuring range is reduced to 23.6 mm ... 28.6 mm.

³⁾ Measurement at 90% remission (ceramic, white), or mirror for OD5-25x; averaging set to: 256 or 4096 for OD5-25x; constant ambient conditions.

⁴⁾ Time needed for automatic sensitivity adjustment is calculated as: sampling period x 20. At default setting 100 μs (10kHz) this is ≤ 2ms.

⁵⁾ Default setting for OD5-350x100 and OD5-500x200 = 0.8 ms, or 1.25 kHz, all others = 0.1 ms/10 kHz.

⁶⁾ Wavelength: 658 nm, max. output: 1 mW.

	Specular $\pm 4 \mu\text{m}$ ³⁾
Response time	$\geq 0.1 \text{ ms}$ ^{4) 5)}
Measuring frequency	$\leq 10 \text{ kHz}$ ^{1) 5)}
Output time	$\geq 0.1 \text{ ms}$
Light source	Laser, red visible red light
Laser class	2 (IEC 60825-1:2014, EN 60825-1:2014) ⁶⁾
Typ. light spot size (distance)	30 μm x 100 μm (30 mm)
Special task	Thickness measurement of transparent material
Additional function	Mean-value setting 1 ... 4,096x, selectable measuring frequency (automatic / 0.1 ms ... 3.2 ms), automatic sensitivity adjustment, manual sensitivity adjustment, Mutual interference, Glass thickness measurement
Thickness measurement of transparent material	0.7 mm ... 5 mm

1) 6 % ... 90 % remission; at default settings.

2) If there are reflections, the measuring range is reduced to 23.6 mm ... 28.6 mm.

3) Measurement at 90% remission (ceramic, white), or mirror for OD5-25x; averaging set to: 256 or 4096 for OD5-25x; constant ambient conditions.

4) Time needed for automatic sensitivity adjustment is calculated as: sampling period x 20. At default setting 100 μs (10kHz) this is $\leq 2\text{ms}$.

5) Default setting for OD5-350x100 and OD5-500x200 = 0.8 ms, or 1.25 kHz, all others = 0.1 ms/10 kHz.

6) Wavelength: 658 nm, max. output: 1 mW.

Interfaces

Serial	✓, RS-422
Remark	RS-232 optional via external evaluation unit AOD5
Digital output	
Number	5 ¹⁾
Type	PNP / NPN
Maximum output current I_A	$\leq 100 \text{ mA}$
Analog output	
Number	3 ^{1) 2)}
Type	Current output / voltage output
Current	4 mA ... 20 mA, $\leq 300 \Omega$
Voltage	0 V ... 10 V ³⁾
Laser-off input	1 x laser-off

1) Optional over evaluation unit AOD5.

2) A maximum of three current and three voltage outputs are possible via the AOD5 evaluation unit.

3) Output resistance 100 Ω , min. load 10 k Ω .

Ambient data

Ambient temperature, operation	-10 °C ... +50 °C
Ambient temperature, storage	-20 °C ... +60 °C
Relative air humidity (non-condensing)	35 % ... 85 %
Temperature drift	$\pm 0.01 \text{ % FS/K}$ (FS = Full Scale = Measuring range of sensor)
Typ. Ambient light immunity	Artificial light: $\leq 3,000 \text{ lx}$ Sunlight: $\leq 10,000 \text{ lx}$
Vibration resistance	10 Hz ... 55 Hz (amplitude 1.5 mm, x-, y-, z-axis 2 hours each)

Shock resistance	50 G (x, y, z axis 3 times each)
-------------------------	----------------------------------

General notes

Note on use	OD Precision sensor head can be used in combination with AOD5-P/N1 or stand-alone via RS-422
--------------------	--

Classifications

eCl@ss 5.0	27270801
eCl@ss 5.1.4	27270801
eCl@ss 6.0	27270801
eCl@ss 6.2	27270801
eCl@ss 7.0	27270801
eCl@ss 8.0	27270801
eCl@ss 8.1	27270801
eCl@ss 9.0	27270801
eCl@ss 10.0	27270801
eCl@ss 11.0	27270801
eCl@ss 12.0	27270916
ETIM 5.0	EC001825
ETIM 6.0	EC001825
ETIM 7.0	EC001825
ETIM 8.0	EC001825
UNSPSC 16.0901	41111613

Dimensional drawing (Dimensions in mm (inch))

OD5-30xxx

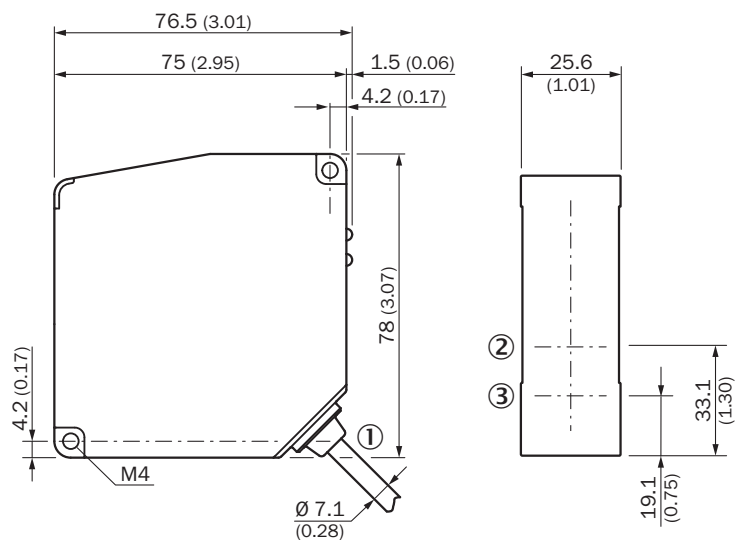

- ① Cable Ø 7.1 mm, 0.5 m with connector, 12-pin
- ② Optical axis, receiver
- ③ Optical axis, sender

Connection type

Hirose 12-pin male connector for sensor head



Connection diagram

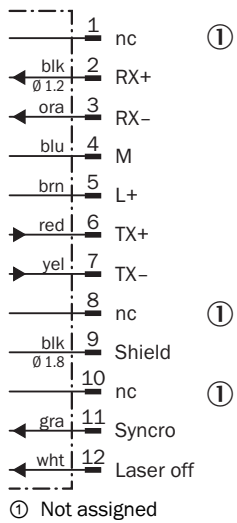

Adjustment possible

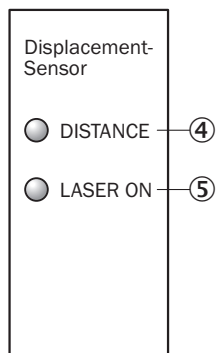

- ④ Distance indicator
- ⑤ Status indicator laser (laser on)

Light spot size

OD5-30T05

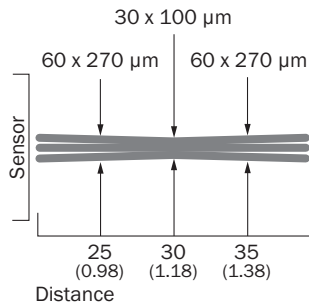

All dimensions in mm (inch)

Linearity

OD5-30T05



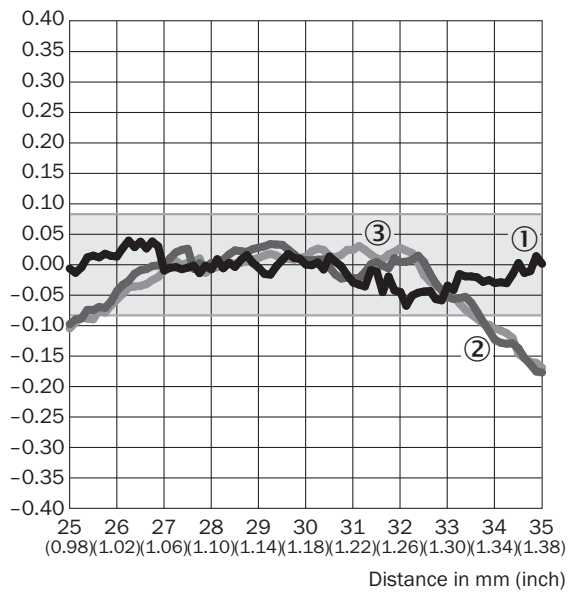

Linearity [%FS]



- ① White ceramic
- ② Stainless steel
- ③ Black rubber

Recommended accessories

Other models and accessories → www.sick.com/OD_Precision

	Brief description	Type	Part no.
Evaluation units			
	Evaluation unit: OD Precision, 5 x NPN	AOD5-N1	6035984
	Evaluation unit: OD Precision, 5 x PNP	AOD5-P1	6035985
Plug connectors and cables			
	Head A: female connector, M12, 12-pin, straight Head B: Flying leads Cable: PVC, shielded, 5 m For stand-alone operation	DOL-1212-G05M	6035988
	Head A: male connector, 50-pin, straight Head B: Flying leads Cable: PVC, shielded, 3 m In- and output expansion cable for AOD5-P/N1 (OD Precision)	IO-EXP-AOD5	6035990
	Head A: female connector, M12, 12-pin, straight Head B: male connector, M12, 12-pin, straight Cable: RS-422, PVC, shielded, 2 m OD Precision specific	YFHRSB-020XXMHRSB	6035986
	Head A: female connector, M12, 12-pin, straight Head B: male connector, M12, 12-pin, straight Cable: RS-422, PVC, shielded, 5 m OD Precision specific	YFHRSB-050XXMHRSB	6035987
	Head A: male connector, 12-pin Head B: terminal connector, 12-pin Cable: unshielded Terminal strip for AOD5-P/N1 (OD Precision)	TERM.-AOD5	6035989

Recommended services

Additional services → www.sick.com/OD_Precision

	Type	Part no.
Commissioning		
<ul style="list-style-type: none"> • Product area: Displacement measurement sensors • Range of services: Inspection of connection and mounting, optimization of parameters of SICK product as well as tests, set-up of previously defined functions of the scaling of the analog measuring range, switching point position, hysteresis, measuring frequency, measured value filter, signal quality, evaluation function, or communication interface • Travel expenses: The prices do not include travel costs such as hotel, flight, travel time and expenses. • Duration: Additional work will be invoiced separately 	DT20 Hi/OD/OL commissioning	1612241
Extended warranty		
<ul style="list-style-type: none"> • Product area: Identification solutions, machine vision, Distance sensors, Detection and ranging solutions • Range of services: The services correspond to the scope of the statutory manufacturer warranty (SICK general terms of delivery). • Duration: Five-year warranty from delivery date. 	Extended warranty for a total of five years from delivery date	1680671

SICK AT A GLANCE

SICK is one of the leading manufacturers of intelligent sensors and sensor solutions for industrial applications. A unique range of products and services creates the perfect basis for controlling processes securely and efficiently, protecting individuals from accidents and preventing damage to the environment.

We have extensive experience in a wide range of industries and understand their processes and requirements. With intelligent sensors, we can deliver exactly what our customers need. In application centers in Europe, Asia and North America, system solutions are tested and optimized in accordance with customer specifications. All this makes us a reliable supplier and development partner.

Comprehensive services complete our offering: SICK LifeTime Services provide support throughout the machine life cycle and ensure safety and productivity.

For us, that is “Sensor Intelligence.”

WORLDWIDE PRESENCE:

Contacts and other locations –www.sick.com