



# AHM36I-S3PJ014x12

AHS/AHM36

**ABSOLUTE ENCODERS**

**SICK**  
Sensor Intelligence.



Illustration may differ



### Ordering information

Type	Part no.
AHM36I-S3PJ014x12	1099378

Other models and accessories → [www.sick.com/AHS\\_AHM36](http://www.sick.com/AHS_AHM36)

### Detailed technical data

#### Performance

<b>Number of steps per revolution (max. resolution)</b>	16,384 (14 bit)
<b>Number of revolutions</b>	4,096 (12 bit)
<b>Max. resolution (number of steps per revolution x number of revolutions)</b>	14 bit x 12 bit (16,384 x 4,096)
<b>Error limits G</b>	0.35° (at 20 °C) <sup>1)</sup>
<b>Repeatability standard deviation <math>\sigma_r</math></b>	0.2° (at 20 °C) <sup>2)</sup>

<sup>1)</sup> In accordance with DIN ISO 1319-1, position of the upper and lower error limit depends on the installation situation, specified value refers to a symmetrical position, i.e. deviation in upper and lower direction is the same.

<sup>2)</sup> In accordance with DIN ISO 55350-13; 68.3% of the measured values are inside the specified area.

#### Interfaces

<b>Communication interface</b>	SSI
<b>Initialization time</b>	100 ms <sup>1)</sup>
<b>Position forming time</b>	125 µs
<b>Process data</b>	Position
<b>Parameterising data</b>	Number of steps per revolution Number of revolutions PRESET Counting direction Code type Offset of position bits Position error bit Round axis functionality SSI mode
<b>Code type</b>	Gray, binary
<b>Code sequence parameter adjustable</b>	CW/CCW (V/R) configurable via programming tool or cable
<b>Clock frequency</b>	2 MHz <sup>2)</sup>

<sup>1)</sup> Valid positional data can be read once this time has elapsed.

<sup>2)</sup> Minimum, LOW level (Clock +): 250 ns.

<b>Set (electronic adjustment)</b>	H-active (L = 0 - 3 V, H = 4,0 - U <sub>s</sub> V)
<b>CW/CCW (counting sequence when turning)</b>	L-active (L = 0 - 1 V, H = 2,0 - U <sub>s</sub> V)

<sup>1)</sup> Valid positional data can be read once this time has elapsed.

<sup>2)</sup> Minimum, LOW level (Clock +): 250 ns.

## Electrical data

<b>Connection type</b>	Cable, 8-wire, universal, 0.5 m
<b>Supply voltage</b>	4.5 ... 32 V DC
<b>Power consumption</b>	≤ 1.5 W (without load)
<b>Reverse polarity protection</b>	✓
<b>MTTFd: mean time to dangerous failure</b>	230 years (EN ISO 13849-1) <sup>1)</sup>

<sup>1)</sup> This product is a standard product and does not constitute a safety component as defined in the Machinery Directive. Calculation based on nominal load of components, average ambient temperature 40 °C, frequency of use 8760 h/a. All electronic failures are considered hazardous. For more information, see document no. 8015532.

## Mechanical data

<b>Mechanical design</b>	Solid shaft, face mount flange
<b>Shaft diameter</b>	6 mm
<b>Shaft length</b>	12 mm
<b>Weight</b>	0.2 kg <sup>1)</sup>
<b>Shaft material</b>	Stainless steel 1,4305
<b>Flange material</b>	Stainless steel 1,4305
<b>Housing material</b>	Stainless steel 1,4305
<b>Material, cable</b>	PUR
<b>Start up torque</b>	1 Ncm (+20 °C)
<b>Operating torque</b>	< 1 Ncm (+20 °C)
<b>Permissible shaft loading</b>	40 N (radial) 20 N (axial)
<b>Operating speed</b>	≤ 6,000 min <sup>-1</sup> <sup>2)</sup>
<b>Moment of inertia of the rotor</b>	2.5 gcm <sup>2</sup>
<b>Bearing lifetime</b>	3.6 x 10 <sup>8</sup> revolutions
<b>Angular acceleration</b>	≤ 500,000 rad/s <sup>2</sup>

<sup>1)</sup> Based on devices with male connector.

<sup>2)</sup> Allow for self-heating of 3.5 K per 1,000 rpm when designing the operating temperature range.

## Ambient data

<b>EMC</b>	According to EN 61000-6-2 and EN 61000-6-3
<b>Enclosure rating</b>	IP67 (IEC 60529) IP69K (IEC 60529)
<b>Permissible relative humidity</b>	90 % (Condensation not permitted)
<b>Operating temperature range</b>	-40 °C ... +100 °C
<b>Storage temperature range</b>	-40 °C ... +100 °C, without package
<b>Resistance to shocks</b>	100 g, 6 ms (EN 60068-2-27)

<sup>1)</sup> For side-mounted encoders (horizontal encoder shaft, vertical stator coupling), additional damping measures may be required in some cases as resonances can arise. Furthermore, the cable must be fastened with the shortest possible distance to the encoder.



Type	Shaft diameter Ø D f7	B	H
AHx36x-S8xxxxxxx	3/8"	4,35 mm	9 mm
AHx36x-SBxxxxxxx			
AHx36x-S7xxxxxxx			

Attachment specifications

Solid shaft, face mount flange with flange adapter, centering collar D20 on D24 (BEF-FA-020-024-I, 2103982)

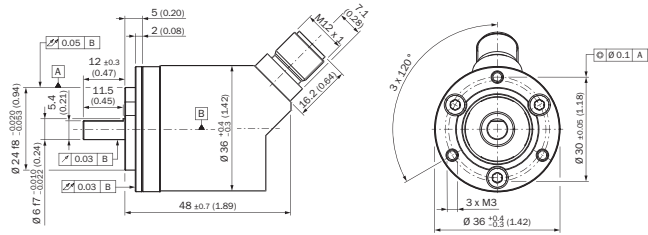

Order example for 6 mm shaft diameter: AHx36I-S3xx0xxxx + BEF-FA-020-024-I (adapter is not pre-assembled)

Solid shaft, face mount flange with flange adapter, centering collar D20 on D36, 2 mm high (BEF-FA-020-036-2-I, 2103984)

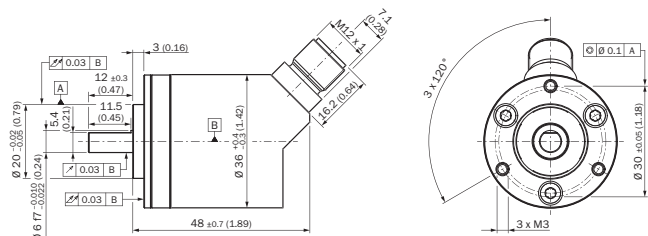

Order example for 6 mm shaft diameter: AHx36I-S3xx0xxxx + BEF-FA-020-036-2-I (adapter is not pre-assembled)

Solid shaft, face mount flange with flange adapter, centering collar D20 on D50 (BEF-FA-020-050-I, 2103985)

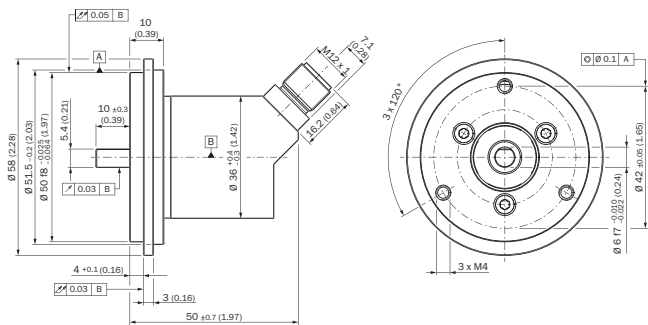

Order example for 6 mm shaft diameter: AHx36I-S3xx0xxxx + BEF-FA-020-050-I (adapter is not pre-assembled)



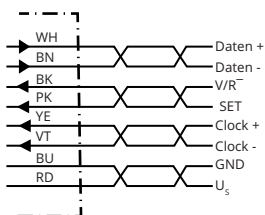



PIN assignment





PIN	Wire colors (cable connection)	Signal	Explanation
1	Brown	Data -	Interface signals
2	White	Data +	Interface signals
3	Black	V/R	Sequence in direction of rotation
4	Pink	SET	Electronic adjustment Interface signals
5	Yellow	Clock +	Interface signals
6	Purple	Clock -	Interface signals
7	Blue	GND	Ground connection
8	Red	U <sub>S</sub>	Operating voltage
		Screen	Screen connected to housing on encoder side. Connected to ground on control side.

### Recommended accessories

Other models and accessories → [www.sick.com/AHS\\_AHM36](http://www.sick.com/AHS_AHM36)

	Brief description	Type	Part no.
<b>Programming and configuration tools</b>			
	USB programming unit, for programmable SICK encoders AFS60, AFM60, DFS60, VFS60, DFV60 and wire draw encoders with programmable encoders	PGT-08-S	1036616
	Programming unit display for programmable SICK DFS60, DFV60, AFS/AFM60, AHS/AHM36 encoders, and wire draw encoder with DFS60, AFS/AFM60 and AHS/AHM36. Compact dimensions, low weight, and intuitive operation.	PGT-10-Pro	1072254
<b>Plug connectors and cables</b>			
	<ul style="list-style-type: none"> <li>• <b>Connection type head A:</b> Female connector, M12, 8-pin, straight, A-coded</li> <li>• <b>Description:</b> Shielded</li> <li>• <b>Connection systems:</b> Screw-type terminals</li> <li>• <b>Permitted cross-section:</b> 0.25 mm<sup>2</sup> ... 0.5 mm<sup>2</sup></li> <li>• <b>Application:</b> Hygienic and washdown zones</li> </ul>	YF12ES8-0050S5586A	2097334
	<ul style="list-style-type: none"> <li>• <b>Connection type head A:</b> Male connector, M12, 8-pin, straight, A-coded</li> <li>• <b>Description:</b> Shielded</li> <li>• <b>Connection systems:</b> Screw-type terminals</li> <li>• <b>Permitted cross-section:</b> ≤ 0.5 mm<sup>2</sup></li> <li>• <b>Application:</b> Hygienic and washdown zones</li> </ul>	YM12ES8-0050S5586A	2097337
<b>Shaft adaptation</b>			
	Bellows coupling, shaft diameter 6 mm / 6 mm, maximum shaft offset: radial ± 0.25 mm, axial ± 0.4 mm, angular +/- 4°; max. speed 10,000 rpm, -30 °C to +120 °C, max. torque 120 Ncm; material: stainless steel bellows, aluminum hub	KUP-0606-B	5312981
	Bellows coupling, shaft diameter 6 mm / 10 mm, maximum shaft offset: radial ± 0.25 mm, axial ± 0.4 mm, angular +/- 4°; max. speed 10,000 rpm, -30 °C to +120 °C, max. torque 120 Ncm; material: stainless steel bellows, aluminum hub	KUP-0610-B	5312982
	Double loop coupling, shaft diameter 6 mm / 10 mm, max. shaft offset: radially +/- 2,5 mm, axially +/- 3 mm, angle +/- 10 degrees; max. speed 3.000 rpm, -30 to +80 degrees Celsius, torsional spring stiffness of 25 Nm/rad	KUP-0610-D	5326697

	Brief description	Type	Part no.
	Spring washer coupling, shaft diameter 6 mm / 10 mm, Maximum shaft offset: radial +/- 0.3 mm, axial +/- 0.4 mm, angular +/- 2.5°; max. speed 12,000 rpm, -10° to +80 °C, max. torque 60 Ncm; material: aluminum flange, glass fiber-reinforced polyamide membrane and hardened steel coupling pin	KUP-0610-F	5312985
	Claw coupling, shaft diameter 6 mm / 10 mm, damping element 80 shore blue, maximum shaft offset: radial ± 0.22 mm, axial ± 1 mm angular ± 1.3°, max. speed 19,000 rpm, angle of twist max. 10°, -30 °C to +80 °C, max. torque 800 Ncm, tightening torque of screws: ISO 4029 150 Ncm, material: aluminum flange, damping element: polyurethane	KUP-0610-J	2127056
Others			
	<ul style="list-style-type: none"> <li>• <b>Connection type head A:</b> Female connector, terminal box, 8-pin, straight</li> <li>• <b>Connection type head B:</b> Male connector, D-Sub, 9-pin, straight</li> <li>• <b>Signal type:</b> SSI + incremental</li> <li>• <b>Cable:</b> 0.5 m, 4-wire, PVC</li> <li>• <b>Description:</b> SSI + incremental, shielded, Programming cable for PGT-08-S and PGT-10-S programming tool</li> <li>• <b>Note:</b> Programming adapter cable for programming tool PGT-10-Pro and PGT-08-S</li> </ul>	DSL-0D08-G0M5AC3	2061739

## SICK AT A GLANCE

SICK is one of the leading manufacturers of intelligent sensors and sensor solutions for industrial applications. A unique range of products and services creates the perfect basis for controlling processes securely and efficiently, protecting individuals from accidents and preventing damage to the environment.

We have extensive experience in a wide range of industries and understand their processes and requirements. With intelligent sensors, we can deliver exactly what our customers need. In application centers in Europe, Asia and North America, system solutions are tested and optimized in accordance with customer specifications. All this makes us a reliable supplier and development partner.

Comprehensive services complete our offering: SICK LifeTime Services provide support throughout the machine life cycle and ensure safety and productivity.

For us, that is “Sensor Intelligence.”

## WORLDWIDE PRESENCE:

Contacts and other locations –[www.sick.com](http://www.sick.com)